

TimberForm® & PipeLine®

Playground Equipment Catalog

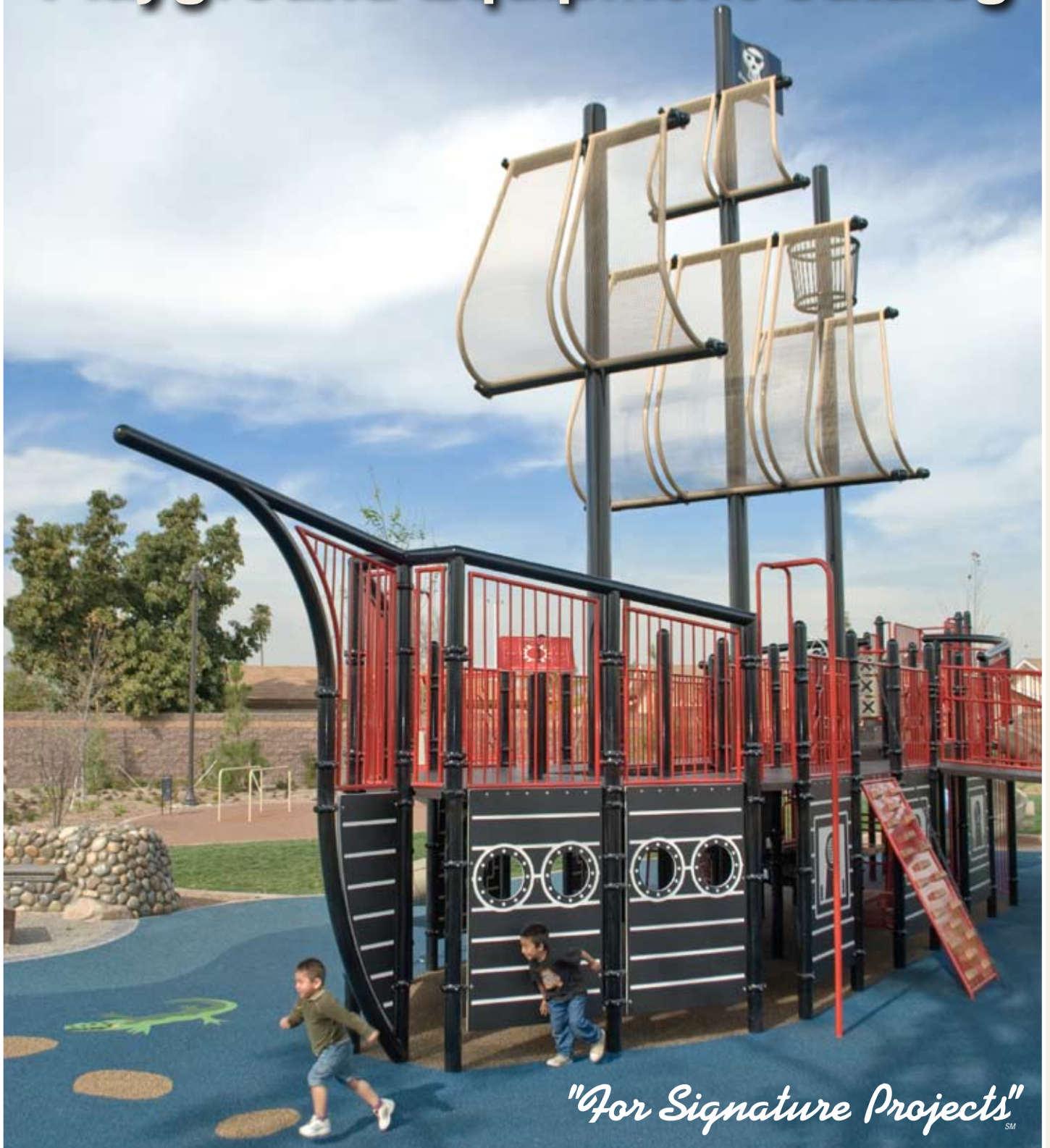

"For Signature Projects" SM



Moodie
Outdoor Products

www.moodie.com.au
sales@moodie.com.au
1300 666 343



2-A



2-B



"For Signature Projects"



3-A



3-B



3-C

Photo Gallery

TimberForm-2® PipeLine® RePlay® InterPlay®



4-A



4-B



4-C

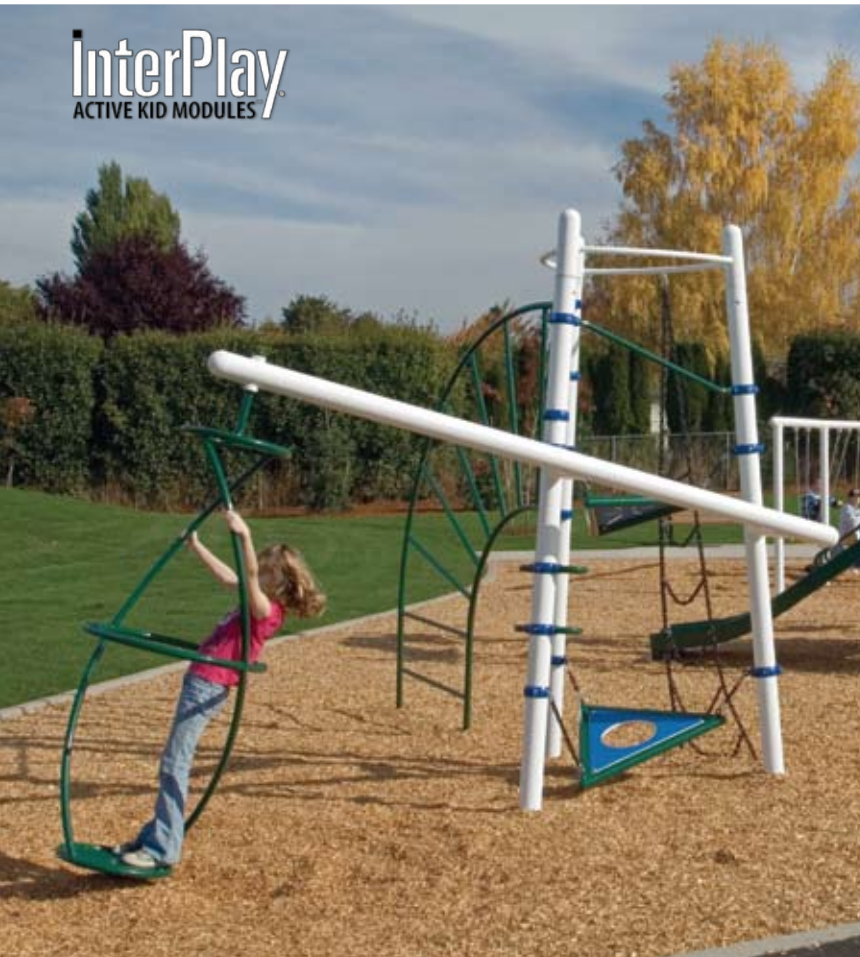

4-D



4-E



5-A



5-B



5-C



5-D

Eco-friendly

Columbia Cascade Company has been committed to producing eco-friendly playground equipment since its inception. All of our products and finishes are made from non-toxic materials. Our factory and offices are operated and maintained in an environmentally responsible manner.

Our Products



- All of our metal components are coated with CASPAX-7, a lead-free powder coating.
- The steel pipe used in our products contains 95-100% post-consumer recycled metal.
- We do not use lead-containing galvanized coatings on playground equipment parts that could come in contact with children's skin.

- Our plastic accessories and components contain no Polyvinyl Chloride (PVC).
- Our plastic accessories and components contain no Phthalates.
- TimberForm RePlay plastic timbers are made from 100% recycled post-consumer plastic products. This structural play system is the most environmentally friendly choice available when selecting new playground equipment.
- Our child-friendly wood preservative is not and never has been arsenic based.
- Our "playground equipment grade" Douglas fir timbers are obtained from sources that adhere to strict and ecologically sound sustained yield practices. For every tree that is felled for playground equipment use, at least three superior seedlings are planted.
- Many of our playground equipment products can help in achieving LEED® credits for your project.



Our Manufacturing Plant

- Our production facility employs strict environmental management practices.
- The dry finish CASPAX-7 powder-coating process emits no volatile solvents to the atmosphere and is ecologically sound.
- We do not allow factory emissions of any kind.
- Using energy efficient fluorescent lamps, factory lighting is motion controlled and task oriented.
- Factory storm water is diverted to on-site engineered bio-swales rather than to a stream or public sewer system.
- All production scrap (metal, wood and plastic) is recycled.
- Wooden shipping pallets are salvaged, repaired and reused.
- All new cardboard packaging is produced only from recycled paper products.

Our Design Headquarters and Offices

- Our headquarters location was selected for easy access to the expanded light-rail line in the geographical center of Portland, Oregon. We encourage our employees to commute to work via mass-transit or alternative transportation.
- The company provides on-site bicycle racks and monthly transit passes for employees. On-site showers and changing rooms are available to cyclists.
- To conserve energy and natural resources, we discontinued the industry practice of mass-mailings of paper catalogs over ten years ago. Although we still print a limited number of catalogs for hand distribution, we encourage the online downloading of PDF copies.
- All paper, plastic and metal waste is segregated and recycled. Obsolete computer equipment is delivered to authorized recyclers.

LEED is a registered trademark of the U.S. Green Building Council.



Other Columbia Cascade Products

Columbia Cascade also produces a complete line of site complements, bicycle parking solutions and outdoor fitness systems. To obtain a catalog contact your local Columbia Cascade representative or our headquarters at Portland, Oregon. All of our catalogs are available as downloadable PDF files at our web site www.timberform.com. Look for the category entitled Current Publications.

TimberForm Site Furnishings



CycLoops & CycLocker Bicycle Management

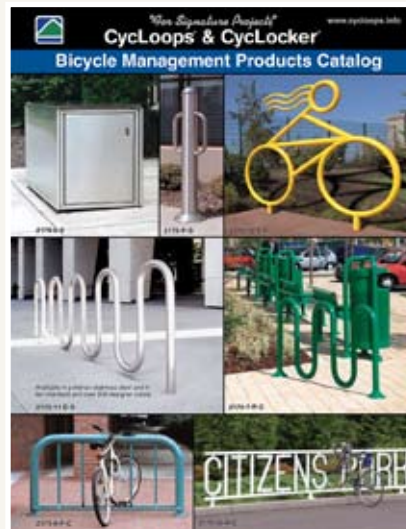

TimberForm & PipeLine Outdoor Fitness Systems



Themed Play



PipeLine



InterPlay



TimberForm-2 & RePlay



Current Designs and Specifications

As a safety- and quality-conscious manufacturer, we are constantly improving our products to better serve our ultimate and most important customers, the players who will use the equipment. Therefore, all designs, product features and specifications depicted in this catalog are subject to change without notice.



Please pass this catalog along to others who may be interested in playground equipment subject matter. Or, rather than discarding as waste, please recycle.

© Copyright 2009 Columbia Cascade Company.
All rights reserved. Printed in U.S.A.

Introduction 8

Themed Play Areas 10
Our Designs or Your Ideas

PipeLine® Play Areas 27
The Toughest Metal Play System

InterPlay® Activities 53
Active Kid Modules

TimberForm® Play Areas 59
TimberForm-2 & RePlay Designs

Playground Separates 85
Stand Alone Play Activities

Playground Accessories 97
Components for Your Play Area

Product Index 114

Trademarks & Copyright

TimberForm®, PipeLine®, TyreSwing™, RePlay®, InterPlay®, CycLoops®, Separates™, SofDek™, CASPAX-7™, SpringPad™, LogRoll™, MaxTreat™, Vertical Safety Climber™, KidSpinner™, HeloPlayer™, WhirlAround™, Overhead Safety Ladder™, Benny Boa™, TimGrip™, ColorCard™, ColorBook™, Urban Tough™, Active Kid Modules™, For Signature Projects™ and The Green Playground™, are trademarks and servicemarks of Columbia Cascade Company. All original product designs illustrated in this catalog are the intellectual property of Columbia Cascade Company and copyright in the year of their creation.



www.timberform.com

1300 S.W. Sixth Avenue, Suite 310
Portland, Oregon 97201-3464 U.S.A.
Telephone 503/223-1157
e-mail: HQ@timberform.com
Facsimile 503/223-4530

This Catalog

This catalog features new Play Areas as well as a number of popular designs from previous catalogs. All of the new Play Areas, plus many of the Separates and Accessories were created to address the most recent governmental specifications and recommendations. These include the *U.S. Consumer Product Safety Commission (CPSC)*, the *American Society for Testing and Materials (ASTM)*, *F-1487. "Standard Consumer Safety Performance Specification for Playground Equipment for Public Use,"* the *Americans with Disabilities Act*, and European standard *EN 1176* as independently certified by TÜV.

Playground equipment appearing in this catalog has been carefully developed and critiqued by NPSI-certified staff based upon these guidelines plus playground specifier/owner/operator concerns communicated to us regarding playground safety, accessibility and durability.

History

Over forty years ago the **"Playground Revolution"** was initiated by **TimberForm** designs. The form and function of contemporary play facilities were immediately and forever transformed. Today's finest play structures and accessories evolved from radically new concepts originated by TimberForm designs.

Later, **PipeLine** play systems, **"the toughest metal play system in the world"**, replicated in steel, the post and deck concepts of successful TimberForm designs and the evolution continued.

Subsequently, the introduction of **TimberForm-2** offered a new modular post and deck system that reduced the need for many embedded posts and allowed for simplified installation by community volunteers. Friends and neighbors could erect a significant play structure in a several hours on a weekend.

Recently we introduced **TimberForm RePlay** Play Areas. These models feature the same proven structural system as TimberForm-2 but replace the timber members with environmentally friendly 100% recycled post-consumer plastic posts and beams. Specifying TimberForm RePlay can help achieve LEED® Credits for Recycled Content.

The fresh **InterPlay** groupings incorporate tough PipeLine structural elements in deck-free **"Active Kid Modules"** that encourage body enhancing activities for older children.

And finally, **Themed Play** has become a hallmark of Columbia Cascade, whether TimberForm- or PipeLine- based, our Themed Play Areas and accessories are unique in the industry.

Choose from those illustrated here or ask us to create a playground based upon your specific motif. A team of experienced designers is ready to turn your dream into a reality. Naturally, the final Columbia Cascade design will be vetted for conformance to recognized safety standards.

Accessibility to all players is now a prime consideration in the playground equipment selection process. Plus, enhanced safety features make today's playgrounds the most player-friendly ever.

Columbia Cascade has been committed to both safety and accessibility since its origin. Couple this with innovative design, structural integrity, premium materials, durable finishes and the widest selection of customer options offered in the playground equipment industry and it's easy to see why today Columbia Cascade products remain the informed specifier's choice.



Accessibility for All

Accessible Play Areas are identified throughout the catalog with this symbol.

Columbia Cascade has long been active in the design and production of play structures that serve the needs of all children. Many states and the Federal **Americans with Disabilities Act** make accessibility for all children a key consideration in playground design and equipment selection. Accessible Play Areas from each of our play systems as well as several unique Separates and Accessories are presented in this catalog.

Safety

Columbia Cascade has actively and enthusiastically participated in the improvement of playground equipment safety performance standards and guidelines for public playgrounds since they were first proposed. The products presented in this catalog reflect playground equipment safety specifications at the time of publication.

However, it should be noted that the most significant safety factor relating to playground injuries remains the surface beneath and around the equipment. As an equipment manufacturer, we have no control over this most important safety aspect. Therefore, we cannot emphasize the following statement too strongly. It is the most important message you will see in this catalog.



Under no circumstances should play equipment be placed or remain in service upon hard, unyielding surfaces such as concrete, asphalt, compacted earth or turf (natural or synthetic).



We supply TimberForm & PipeLine playground equipment to customers

worldwide. Many of these specifiers rely upon **EN 1176** as their criteria for safe, durable playground equipment. Engineers from **TÜV**, an internationally recognized independent testing agency headquartered in Germany, have inspected our engineering data, factory, materials and quality control systems and products *in situ*. TÜV certifies Columbia Cascade playground equipment to be in compliance with tough European specifications.

We receive many requests from potential customers who want to buy TimberForm or PipeLine components or accessories for attachment to apparatus they have designed and had constructed. Because we have no real knowledge of their apparatus; its structural qualities, materials, placement, or how our component or accessory may, in combination, create a hazard to children, we never sell our playground equipment components for attachment to apparatus we did not make.

PipeLine

PipeLine playground equipment is designed to last. We start with thick-walled 4-1/2" (114mm) diameter Schedule 40 steel pipe posts rather than thin-walled tubing. Smoothly formed aluminum alloy collars are bolted and pinned with stainless steel hardware. The PipeLine connection system is free of sharp edges and protrusions, providing a child-friendly yet rigid connection between posts, rails and accessories.

Exposed post tops are factory capped with cast aluminum domes.

Compare the PipeLine specifications with all others and you'll see why PipeLine is known as **"The toughest metal play system in the world."**

To better withstand the rigors of tough city life, most PipeLine Play Areas can be specified with steel decks and all metal accessories rather than ubiquitous plastic seen on our competitors' offerings. When combined with our Schedule 40 steel pipe the result is a truly **"Urban Fit"** playground.

After attentive preparation, all metal components are color coated with CASPAX-7, lead-free powder coating by skilled applicators.

Lead-Free Powder Coating

All **TimberForm-2**, **RePlay**, **PipeLine** and **InterPlay** "colored" metal is finished with **CASPAX-7** lead-free powder coating. The tough, minimum 6 mil thick coating offers lasting playground performance far superior to liquid finishes.



POWDER COATED TOUGH

CASPAX-7 provides thick, rich colors that are ultraviolet (UV) stabilized, durable and smooth— free from runs, drips or sags. This dry finishing process emits no volatile solvents to the atmosphere and is ecologically sound.

Colors

All metal products and components are offered in ten desirable **ColorCard™** colors plus a spectrum of over 200 designer colors. Standard colors are black, brown, burgundy, Chrome Yellow, Coffee Tan, Evergreen, Ocean Teal, red, Regal Blue and white.

To view the complete selection of available powder-coating colors, ask your representative to show you the Columbia Cascade **ColorBook™**.

Plastic Accessories

Rotationally-molded plastic products that accessorize TimberForm & PipeLine playground equipment are the finest available. Slide Chutes, Tunnel Crawls, Panels and cylindrical accessories such as Tic-Tac-Toe panels are manufactured from hot-compounded medium density polyethylene (M.D.P.E.). Hot-compounding assures uniform coloration within each part and from part to part. Hot-compounding also imparts superior ultraviolet (UV) resistance to minimize the fading effects of the sun's rays. Maximum UV protection also enhances the strength properties of MDPE. The final wall-thickness of our rotationally-molded plastic accessories is 50% thicker than the industry standard low density polyethylene (L.D.P.E.) maximizing strength, durability and long useful life. **Columbia Cascade playground plastics are free of PVC and phthalates.**

Beware specifying or buying cheap vacuum-formed plastic accessories often used on home playground equipment. These products may appear similar in promotional photographs, but in reality they fail to provide durability to last more than a few days in a public playground environment.

SofDek Steel Decks

For added durability, TimberForm, RePlay and PipeLine play structures feature state of the art SofDek plastic-coated perforated steel decks as standard. SofDek lead-free coating provides a durable, textured surface that shields sensitive hands and bare feet from the effects of extreme hot or cold surfaces.

Douglas Fir Timber

TimberForm-2 uses Playground Equipment Grade coastal Douglas fir which is free-of-heart-center (F.O.H.C.). Douglas fir is a tough and durable structural species ideally suited to the demands of playground use when a premium grade is used. It will vary in color from shades of salmon to ivory and eventually turn to a natural sable gray in outdoor settings. The F.O.H.C. specification

is critically important. Timber containing the tree's heart or pith will perform poorly in time and have a short useful life. After seasoning, smooth dressing and fabrication, all wood components are inspected for appearance and suitability for play.

All TimberForm timber posts undergo **MaxTreat** processing prior to pressure-preservative treatment. MaxTreat is an exclusive fabrication procedure that includes two steps, incising and kerfing.

When combined, these two steps greatly enhance pressure-preservative treatment and retention in the sensitive groundline area of embedded posts.

Wood Preservative

All wood components used on our Play Areas and Accessories are pressure-preservatively treated after all fabrication is completed with a child-friendly wood preservative. **We do not and have never used arsenic-based wood preservatives.**

Conserving and Enhancing America's Forests

TimberForm **"Playground Equipment Grade"** timber is obtained by Columbia Cascade from Northwest America sources that adhere to strict and ecologically sound sustained yield practices. For every tree felled for playground equipment use, at least three superior seedlings are planted and available to future generations of players.

TimberForm RePlay

TimberForm RePlay plastic timbers are made from 100% recycled post-consumer plastic products. Recycled plastic is the environmentally friendly choice today when selecting new playground equipment. TimberForm RePlay posts and beams are extruded (not molded) from high density polyethylene (H.D.P.E.). The result is a dense, strong member with uniform surface texture and color throughout so maintenance will be minimal.

Stainless steel **TimGrip** bolts, that provide secure, durable assembly of TimberForm RePlay structures are furnished as standard. Unlike regular timber bolts, TimGrip hardware has unique thread geometry especially designed, tested and proven to securely and permanently grip recycled H.D.P.E. plastic.

Recycled plastic/waste wood composite lumber decking is available as an option.

Community-Built TimberForm-2 and RePlay Playgrounds

Community leaders are changing the face of playgrounds everywhere and TimberForm-2 and RePlay make it easier than ever. Neighbors using readily available home tools can assemble most structures in less than a day. The need for many concreted posts is dramatically reduced

allowing for much simpler and quicker installation by volunteers.

How to Use This Catalog

Within the covers of this catalog, you'll find all-new selections of TimberForm-2, RePlay, PipeLine and InterPlay Play Areas. Hundreds of play accessories are also illustrated. All play systems are modular in design and most accessories are interchangeable, between different systems. This modularity provides the opportunity to create a Play Area that will fulfill the uncompromised needs of the users, the specifier and the owner.

The Play Areas presented in this catalog are just the beginning. We encourage choosing features from several models and melding them into your own unique design. Our design team is ready to assist you.

Custom Design Service

Almost 100 pre-designed Play Areas appear in this catalog, but sometimes a very different solution is desired or required. With talented and experienced staff, Columbia Cascade has always been at the forefront in the creation of custom Play Areas that address specific needs, styles and/or budget considerations. Trained people are available to assist the professional designer or recreator in creating a site-specific custom play facility. Examples of previous creations are shown on the Gallery pages throughout this catalog and even more can be seen by visiting www.timberform.com.

Made in the U.S.A.



Although Columbia Cascade playground equipment is distributed worldwide, all products are fabricated and finished in the USA's Pacific Northwest.

Regional Representatives

We maintain and support a worldwide network of experienced women and men who are familiar with all of our products and are supported by experienced headquarters personnel. Their expertise and assistance regarding budget concerns, product selection, orientation on the site, correct installation and safety related matters can be very beneficial, particularly during the early planning and specifying stages of a project. Planning, fund-raising aids and supervision for community-built playgrounds is offered by our regional representatives.

Additional product information such as drawings, detailed specifications and price lists, plus wood, plastic and coated metal samples, are also available from your nearby representative.

For the name of the Columbia Cascade Company representative serving your geographic area, telephone us **toll-free at: 1-800/547-1940.**



10-A



"For Signature Projects"

10-B





11-A



11-B

Themed Play

Themed Playgrounds

"For Signature Projects"



12-A



12-B



12-C



12-D



12-E



12-F



12-G



13-A



13-B



13-C



13-D



13-E



13-F



13-G



13-H

PipeLine 3807-04-PL "S.S. Fun Ship"

Equipment Only:
27' x 20' (8.3m x 6.1m)
Minimum Safe Use Zone:
39' x 32' (11.9m x 9.8m)



PipeLine 3807-07-PL "Topsail Schooner"

Equipment Only:
56' x 32' (17.1m x 9.8m)
Minimum Safe Use Zone:
68' x 44' (20.8m x 13.5m)



WARNING

METAL PLAYING SURFACES CAN BECOME DANGEROUSLY HOT WHEN EXPOSED TO DIRECT SUNLIGHT. OWNERS/OPERATORS MUST WARN USERS THAT SERIOUS THERMAL BURNS MAY RESULT WHEN BARE SKIN COMES IN CONTACT WITH HOT METAL.

Themed Play



PipeLine 3830-01-PL "Pirate Ship"

Equipment Only:
50' x 29' (15.3m x 8.9m)
Minimum Safe Use Zone:
63' x 41' (19.3m x 12.5m)

Playground ahoy!



Spring Rider See-Saw 3873-2 "Mermaids"



Equipment Only:
11' x 3' (3.4m x 1.0m)

Minimum Safe Use Zone:
23' x 15' (7.1m x 4.6m)

Themed Play



WARNING

INSTALLATION OVER A HARD SURFACE SUCH AS CONCRETE, ASPHALT OR PACKED EARTH MAY RESULT IN SERIOUS INJURY OR DEATH FROM FALLS.

TimberForm 3807-06-TF RePlay 3807-06-RP "Windjammer"

Equipment Only:
52' x 35' (15.9m x 10.7m)
Minimum Safe Use Zone:
64' x 47' (19.5m x 14.4m)

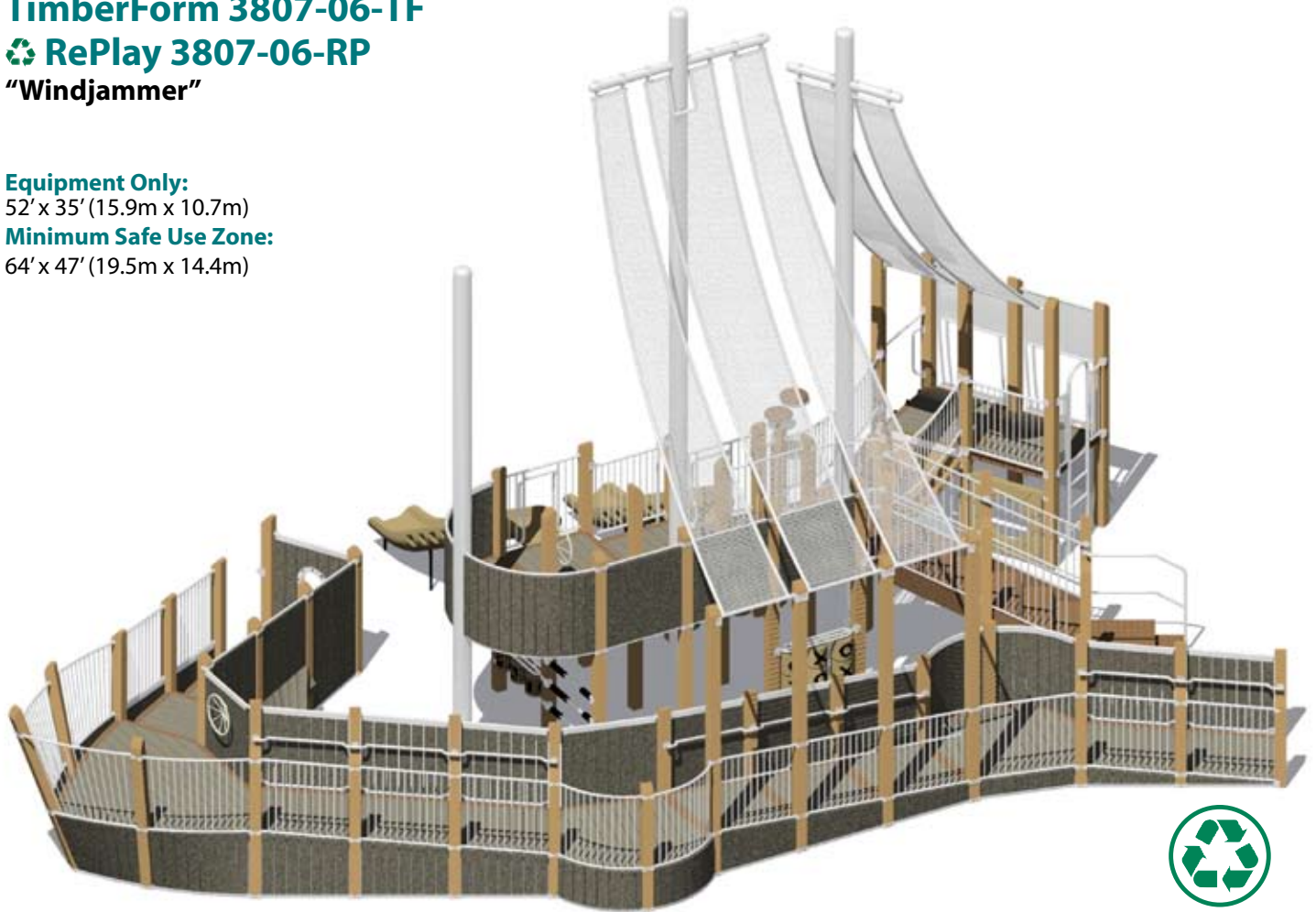

Custom Symbols and Wording

We can personalize the graphics and lettering for Themed Play Areas. Use the name of your local fire or police department, commemorate a celebrated ship or honor a historic person or event.

PipeLine 3807-08-PL "S.S. Shipwreck"

Equipment Only:
26' x 15' (8.0m x 4.6m)
Minimum Safe Use Zone:
38' x 27' (11.6m x 8.3m)





WARNING

METAL PLAYING SURFACES CAN BECOME DANGEROUSLY HOT WHEN EXPOSED TO DIRECT SUNLIGHT. OWNERS/OPERATORS MUST WARN USERS THAT SERIOUS THERMAL BURNS MAY RESULT WHEN BARE SKIN COMES IN CONTACT WITH HOT METAL.

Themed Play

PipeLine 3807-05-PL "Sternwheeler"

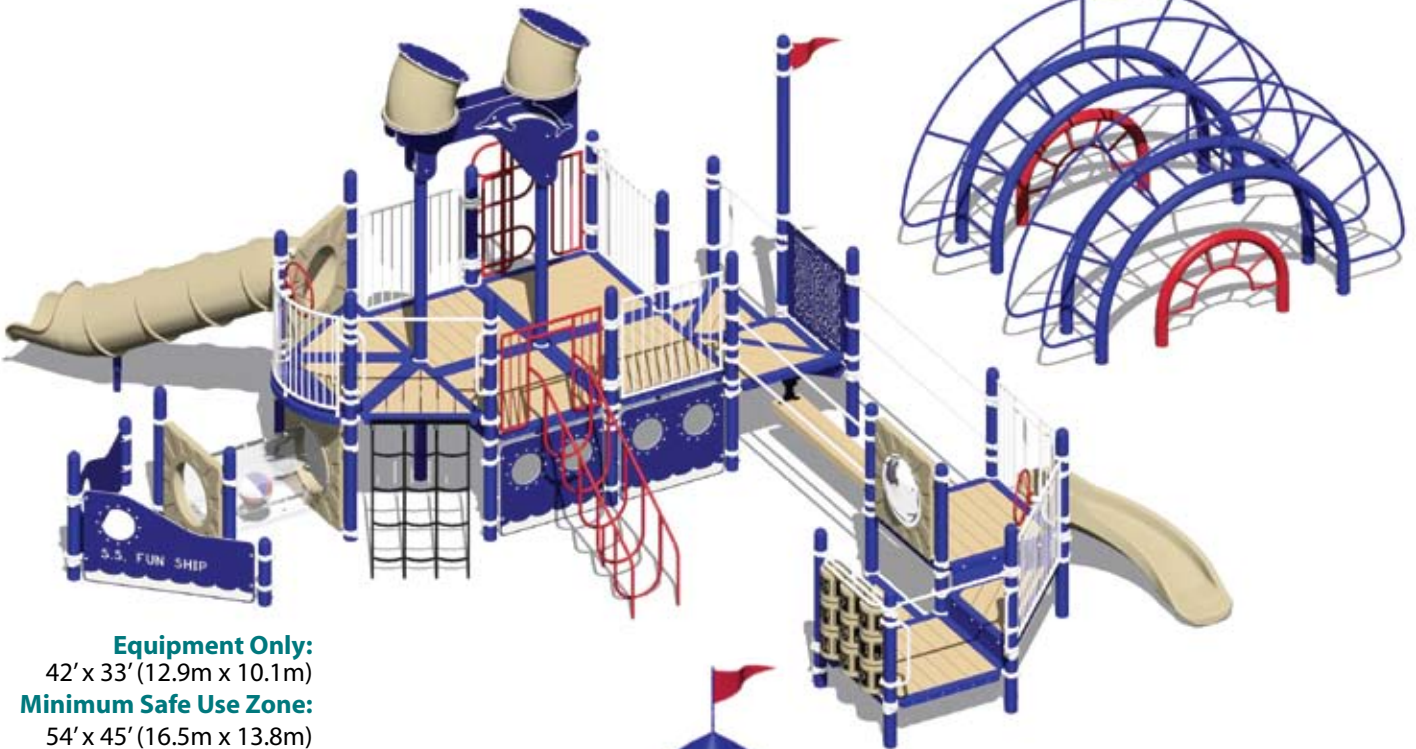

Equipment Only:

42' x 33' (12.9m x 10.1m)

Minimum Safe Use Zone:

54' x 45' (16.5m x 13.8m)

PipeLine 3808-01-PL "Lighthouse"

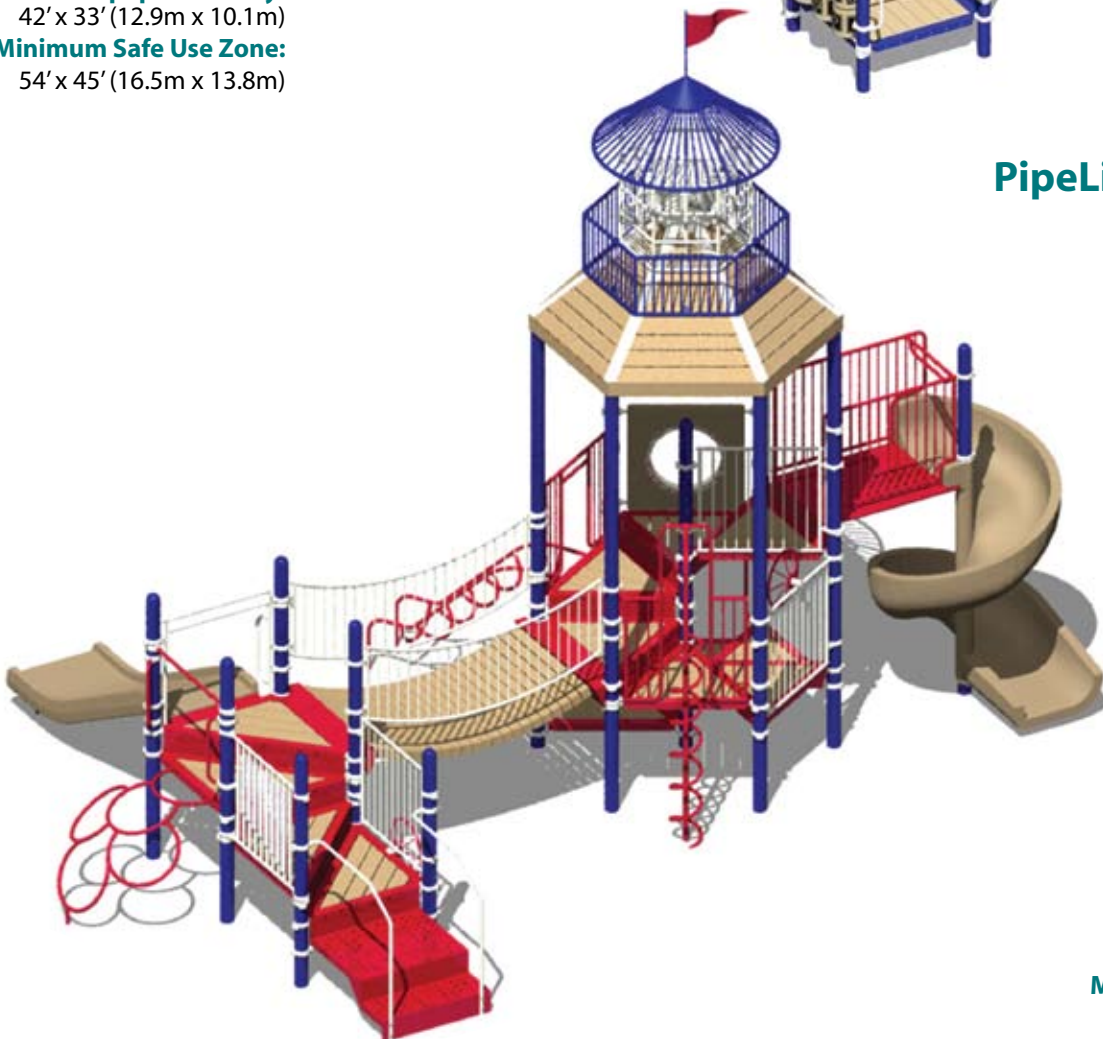

Equipment Only:

31' x 21' (9.5m x 6.5m)

Minimum Safe Use Zone:

43' x 33' (13.2m x 10.1m)

PipeLine 3832-01-PL "Super Biplane"

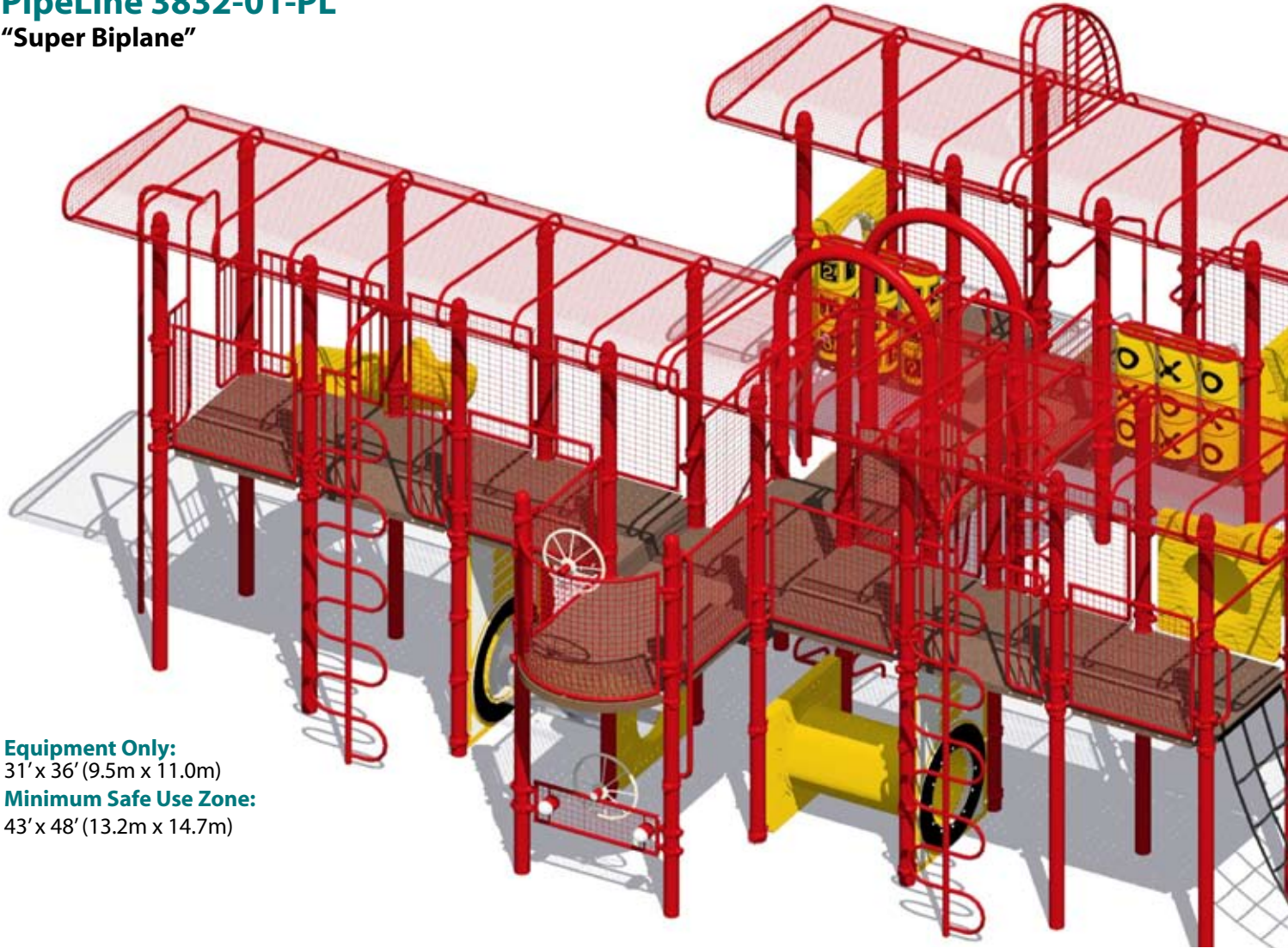

Equipment Only:
31' x 36' (9.5m x 11.0m)
Minimum Safe Use Zone:
43' x 48' (13.2m x 14.7m)

PipeLine 3833-01-PL "HeloPlayer™"

Equipment Only:
25' x 24' (7.7m x 7.4m)
Minimum Safe Use Zone:
37' x 36' (11.3m x 11.0m)



WARNING

METAL PLAYING SURFACES CAN BECOME DANGEROUSLY HOT WHEN EXPOSED TO DIRECT SUNLIGHT. OWNERS/OPERATORS MUST WARN USERS THAT SERIOUS THERMAL BURNS MAY RESULT WHEN BARE SKIN COMES IN CONTACT WITH HOT METAL.

Themed Play

PipeLine 3834-01-PL

“Rocket Ship”

Equipment Only:

23' x 24' (7.1m x 7.4m)

Minimum Safe Use Zone:

35' x 37' (10.7m x 11.3m)

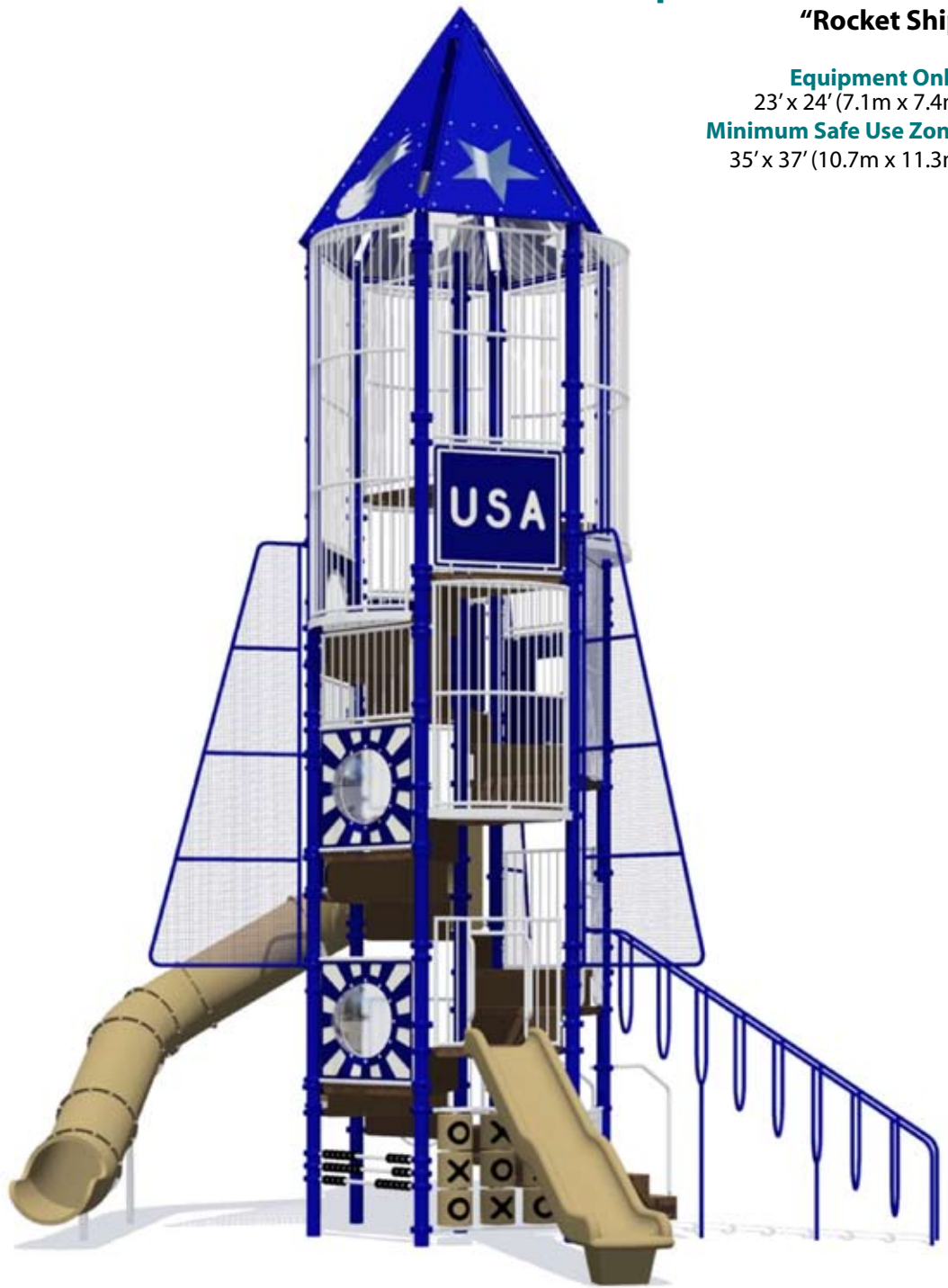

CASPAX-7™ Standard Powder-Coating Colors

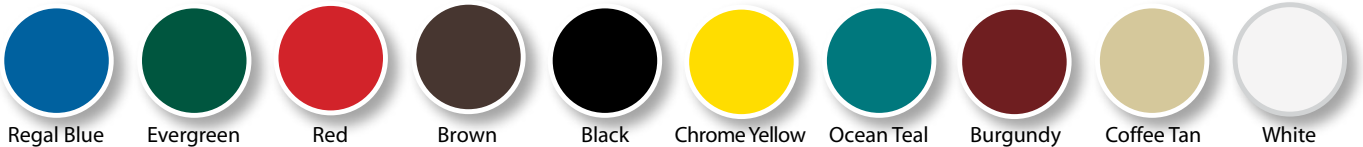

Regal Blue

Evergreen

Red

Brown

Black

Chrome Yellow

Ocean Teal

Burgundy

Coffee Tan

White

Due to variations in the printing process the colors shown above are only a guide to the actual powder-coating colors.

Themed Play



WARNING

INSTALLATION OVER A HARD SURFACE SUCH AS CONCRETE, ASPHALT OR PACKED EARTH MAY RESULT IN SERIOUS INJURY OR DEATH FROM FALLS.

PipeLine 3831-03-PL

“Columbia Express”

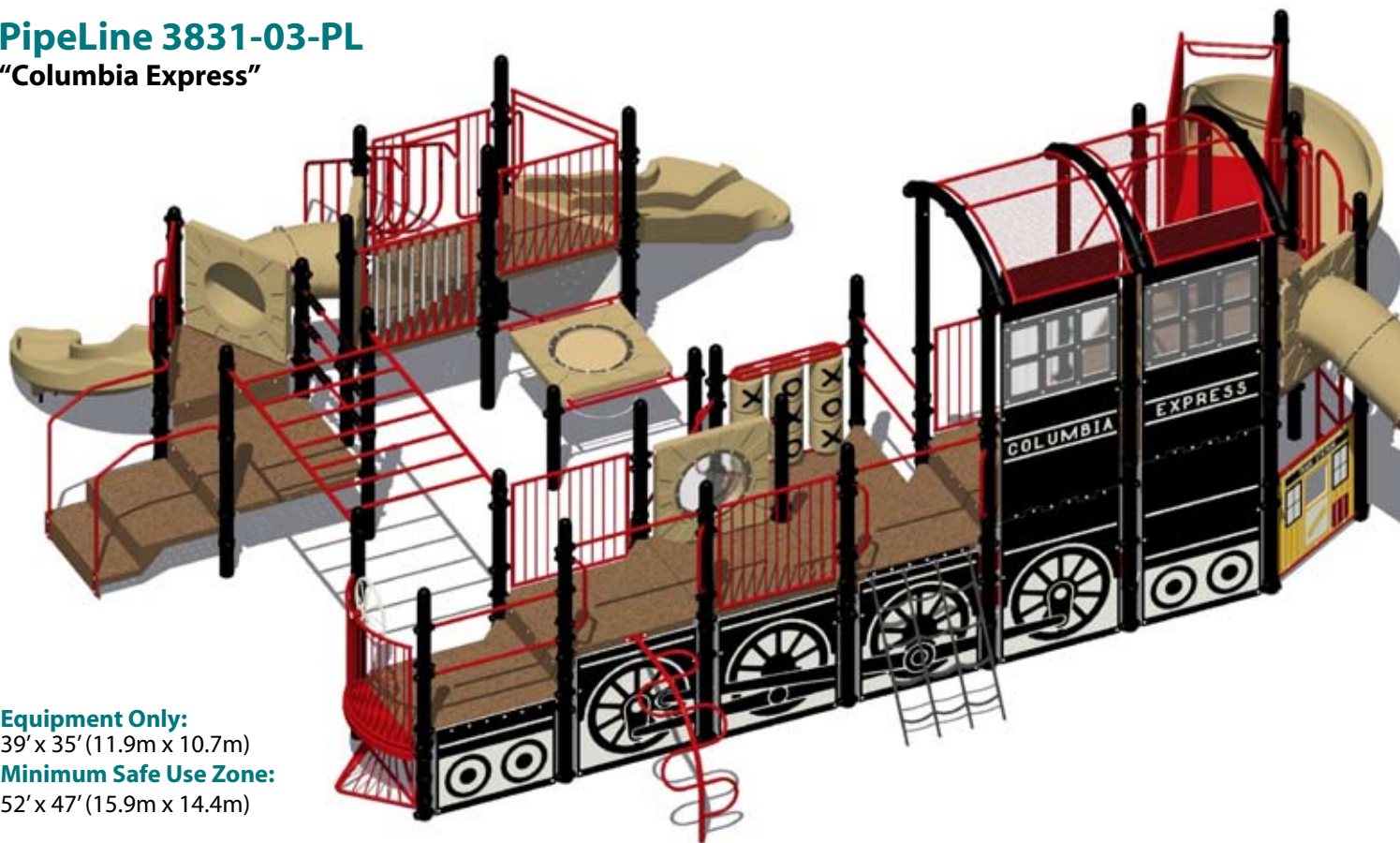

Equipment Only:

39' x 35' (11.9m x 10.7m)

Minimum Safe Use Zone:

52' x 47' (15.9m x 14.4m)

Custom Symbols and Wording

We can personalize the graphics and lettering for Themed Play Areas. Use the name of your local fire or police department, commemorate a celebrated ship or honor a historic person or event.

PipeLine 3824-06-PL

“Hook and Ladder”



Equipment Only:

45' x 21' (13.8m x 6.5m)

Minimum Safe Use Zone:

57' x 33' (17.4m x 10.1m)

WARNING

METAL PLAYING SURFACES CAN BECOME DANGEROUSLY HOT WHEN EXPOSED TO DIRECT SUNLIGHT. OWNERS/OPERATORS MUST WARN USERS THAT SERIOUS THERMAL BURNS MAY RESULT WHEN BARE SKIN COMES IN CONTACT WITH HOT METAL.

Themed Play

PipeLine 3820-00-PL "Conestoga Wagon"

Equipment Only:
17' x 14' (5.2m x 4.3m)
Minimum Safe Use Zone:
29' x 26' (8.9m x 8.0m)



Spring Rider See-Saw 3872-2 "Dalmatians"



Equipment Only:
11' x 3' (3.4m x 1.0m)

Minimum Safe Use Zone:
23' x 15' (7.1m x 4.6m)

PipeLine 3823-08-PL "Police Patrol"



Equipment Only:
13' x 6' (4.0m x 1.9m)
Minimum Safe Use Zone:
25' x 18' (7.7m x 5.5m)

PipeLine 3824-04-PL "Fire Truck"

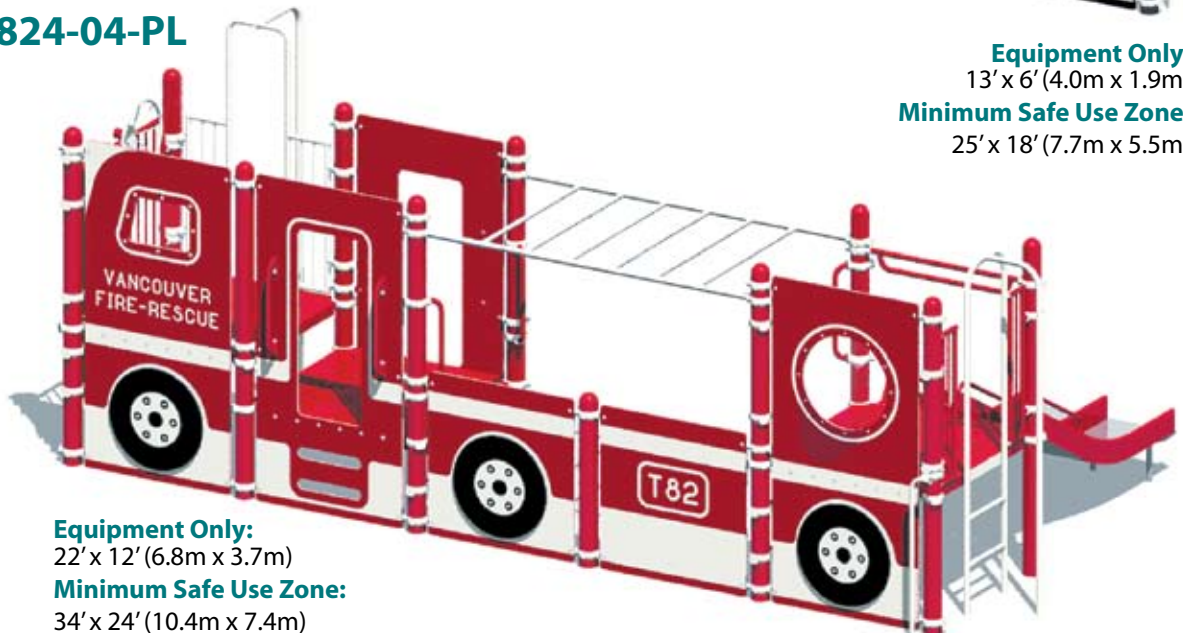

Equipment Only:
22' x 12' (6.8m x 3.7m)

Minimum Safe Use Zone:
34' x 24' (10.4m x 7.4m)

Themed Play



WARNING

INSTALLATION OVER A HARD SURFACE SUCH AS CONCRETE, ASPHALT OR PACKED EARTH MAY RESULT IN SERIOUS INJURY OR DEATH FROM FALLS.

TimberForm 3817-01-TF

"Barn with Silo and Corral"

Equipment Only:

42' x 45' (12.9m x 13.8m)

Minimum Safe Use Zone:

55' x 57' (16.8m x 17.4m)

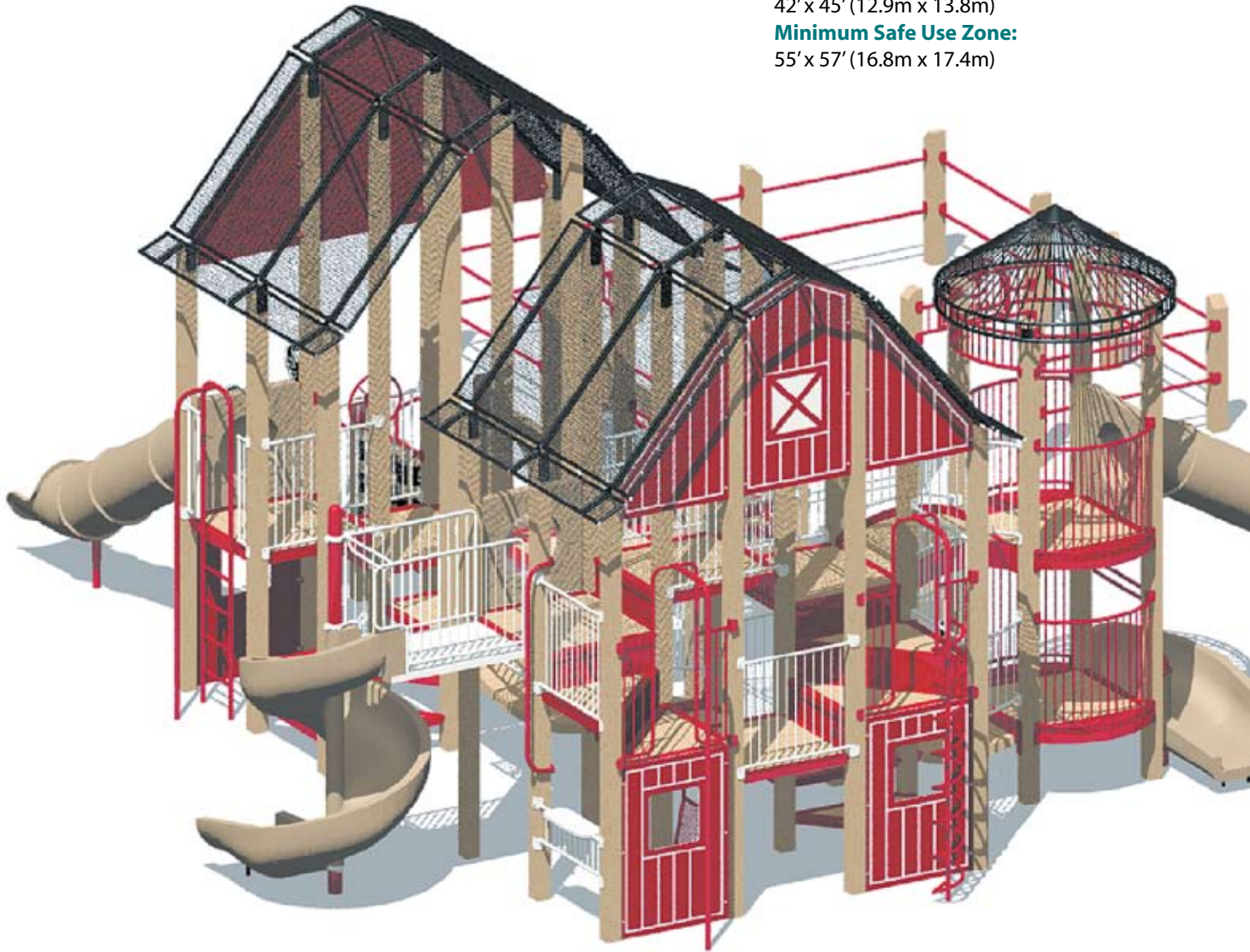

TimberForm 3813-01-TF

"Maize Maze"

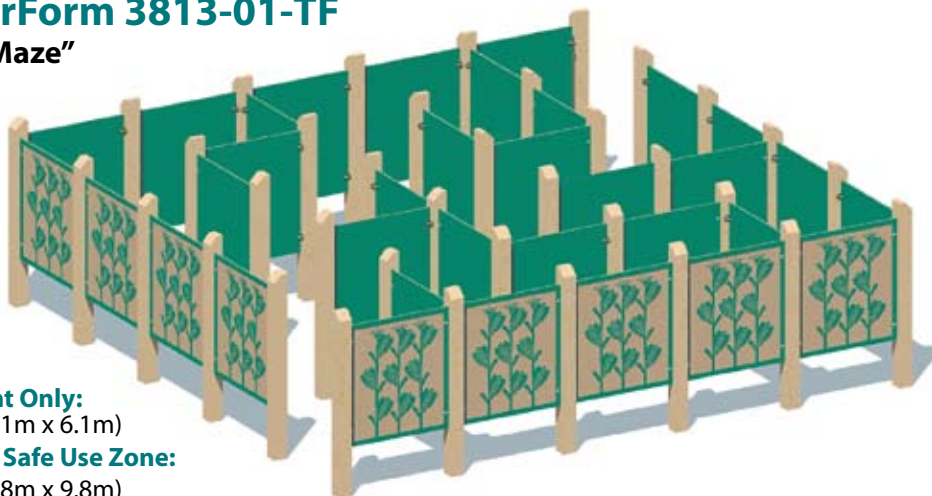

Equipment Only:

20' x 20' (6.1m x 6.1m)

Minimum Safe Use Zone:

32' x 32' (9.8m x 9.8m)

TimberForm Themed Play designs shown here are also available in similar PipeLine versions.



WARNING

METAL PLAYING SURFACES CAN BECOME DANGEROUSLY HOT WHEN EXPOSED TO DIRECT SUNLIGHT. OWNERS/OPERATORS MUST WARN USERS THAT SERIOUS THERMAL BURNS MAY RESULT WHEN BARE SKIN COMES IN CONTACT WITH HOT METAL.

Themed Play

Themed Playground Design Assistance

We can assist in creating a custom themed Play Area design addressing specific needs, styles and budget considerations. Experienced factory consultants are available to help the professional designer or recreator in creating a truly unique, site-specific themed playground. Telephone us at 1-800/547-1940 to start the discussion.

TimberForm 3815-02-TF "Tractor"



Equipment Only:

17' x 5' (5.2m x 1.6)

Minimum Safe Use Zone:

29' x 17' (8.9m x 5.2m)

Also available in PipeLine version.

PipeLine 3817-03-PL "Barn"



Equipment Only:

24' x 16' (7.4m x 4.9m)

Minimum Safe Use Zone:

36' x 28' (11.0m x 8.6m)

Also available in TimberForm version.

Themed Play



WARNING

INSTALLATION OVER A HARD SURFACE SUCH AS CONCRETE, ASPHALT OR PACKED EARTH MAY RESULT IN SERIOUS INJURY OR DEATH FROM FALLS.

TimberForm 3836-01-TF

RePlay 3836-01-RP

“Cattle Ranch”

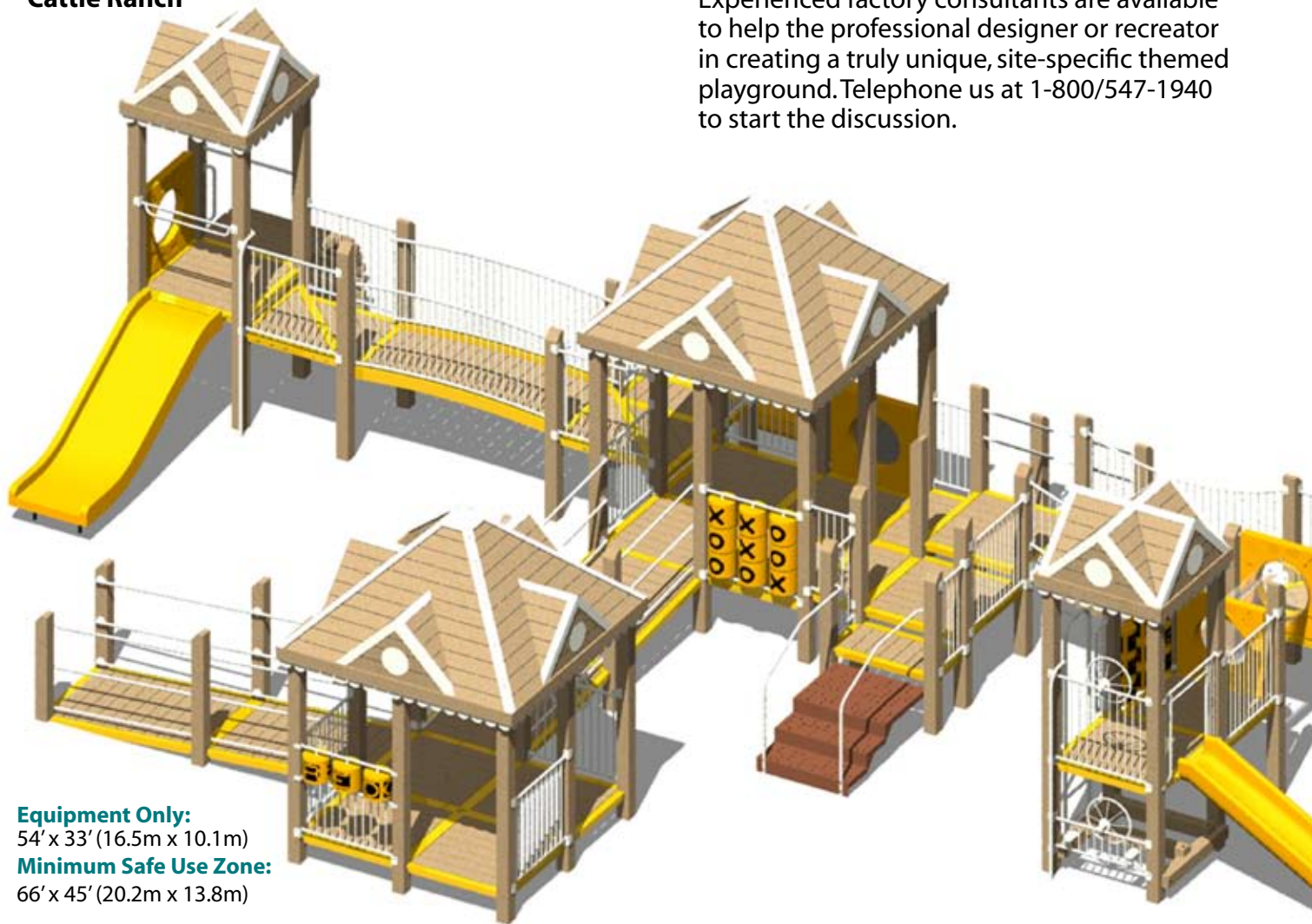

Equipment Only:

54' x 33' (16.5m x 10.1m)

Minimum Safe Use Zone:

66' x 45' (20.2m x 13.8m)

Themed Playground Design Assistance

Experienced factory consultants are available to help the professional designer or recreator in creating a truly unique, site-specific themed playground. Telephone us at 1-800/547-1940 to start the discussion.

TimberForm 3819-01-TF

RePlay 3819-01-RP

“Corral with Pony Spring Rider”

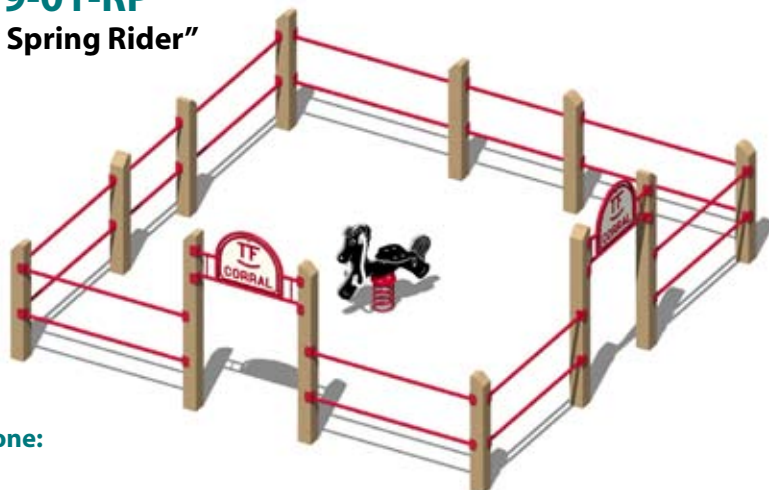

Equipment Only:

16' x 16' (4.9m x 4.9m)

Minimum Safe Use Zone:

28' x 28' (8.6m x 8.6m)

WARNING

METAL PLAYING SURFACES CAN BECOME DANGEROUSLY HOT WHEN EXPOSED TO DIRECT SUNLIGHT. OWNERS/OPERATORS MUST WARN USERS THAT SERIOUS THERMAL BURNS MAY RESULT WHEN BARE SKIN COMES IN CONTACT WITH HOT METAL.

Themed Play

PipeLine 3815-04-PL "Super Tractor"



Equipment Only:
32' x 24' (9.8m x 7.4m)
Minimum Safe Use Zone:
44' x 37' (13.5m x 11.3m)



PipeLine 3827-01-PL "Fantasy Castle"

Equipment Only:
42' x 29' (12.9m x 8.9m)
Minimum Safe Use Zone:
54' x 41' (16.5m x 12.5m)





PipeLine 3835-01-PL

"Railroad Station & Complete Train"

Equipment Only:

57' x 35' (17.4m x 10.7m)

Minimum Safe Use Zone:

69' x 47' (21.1m x 14.4m)



PipeLine 3821-00-PL

"Complete Train"



Equipment Only:

54' x 12' (16.5m x 3.7m)

Minimum Safe Use Zone:

66' x 24' (20.2m x 7.4m)

PipeLine 3825-01-PL

"Trolley Car"

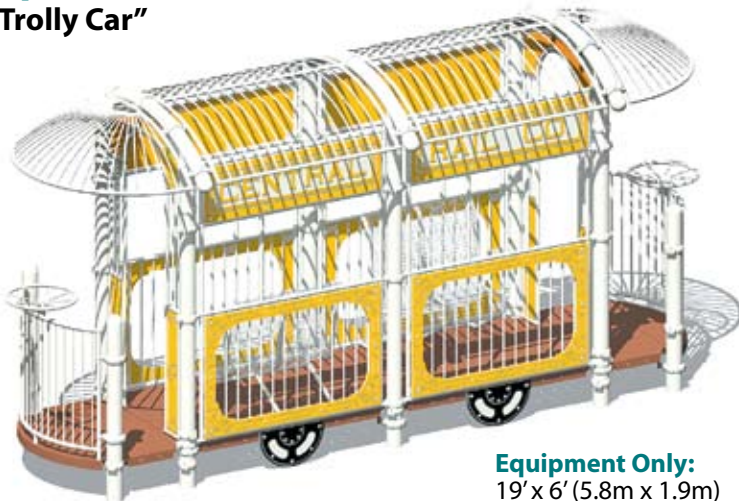

Equipment Only:

19' x 6' (5.8m x 1.9m)

Minimum Safe Use Zone:

31' x 18' (9.5m x 5.5m)

Individual Rail Cars:

3821-01-PL "Locomotive"

3821-02-PL "Tender"

3821-03-PL "Flat Car"

3821-04-PL "Freight Car"

3821-05-PL "Tank Car"

3821-06-PL "Dining Car"

3821-07-PL "Passenger Car"

3821-08-PL "Caboose"

Individual Rail Car

Minimum Safe Use Zone: Varies

The Toughest Metal Play System

PipeLine[®]



27-A



27-B



27-C



27-D



27-E



27-F



27-G



27-H



28-A



28-B



28-C



28-D

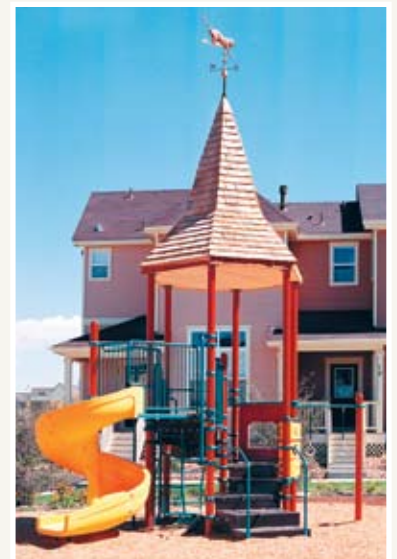

28-E



29-A



29-B



29-C



29-D



29-E

Model No. 9804

Appropriate for Children 2 to 5 Years of Age.

Play Area, Equipment Only:

15' x 17' (4.6m x 5.2m)

Minimum Safe Use Zone:

27' x 29' (8.3m x 8.9m)

Accessibility Profile:

7 Total Play Components

5 Elevated Play Components
(5 Accessible)

2 Ground Level Play Components
(2 Accessible)

Colors Illustrated:

Posts: Black

Accessories: Black, Evergreen & Red

Decks: Perforated Steel, Evergreen

Plastic: Yellow

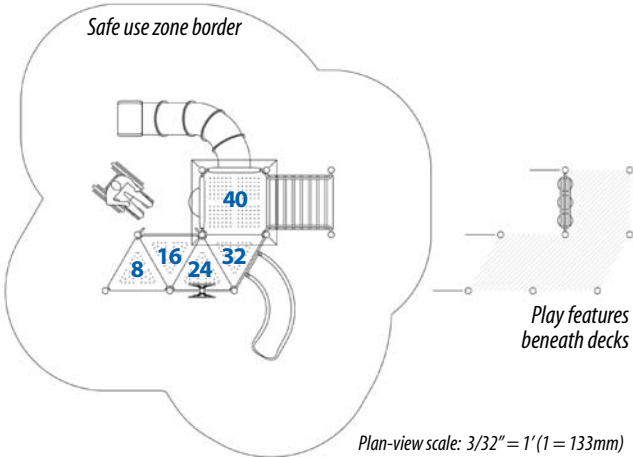

9804 Features:

- Accessible Entrance Deck
- Baluster Wall with Two Ship's Wheels
- Bubble Panel
- Grade Climber, Steel with Handrails
- Perforated Steel Roof
- Spelling Panel
- Tot Slide Chute, Curved
- Tube Chute, Curved
- Welcome/Rules Sign

Deck Heights:

8"	205mm
16"	405mm
24"	610mm
32"	815mm
40"	1015mm



9804 Alternative Color Schemes:



Play Area, Equipment Only:

13' x 10' (4.0m x 3.1m)

Minimum Safe Use Zone:

25' x 22' (7.7m x 6.8m)

Accessibility Profile:

- 4 Total Play Components
- 3 Elevated Play Components (3 Accessible)
- 1 Ground Level Play Components (1 Accessible)

Appropriate for Children 2 to 5 Years of Age.

Model No. 9808

Colors Illustrated:

- Posts:** Evergreen
- Accessories:** Coffee Tan
- Decks:** SofDek Plastic-coated Perforated Steel, Brown
- Plastic:** Tan



9808 Features:

- Accessible Transfer Station, 8" (21 cm) Riser
- Block Climber
- Convex/Flat Mirror Panel
- Roof
- Tot Slide Chute, Curved
- Welcome/Rules Sign

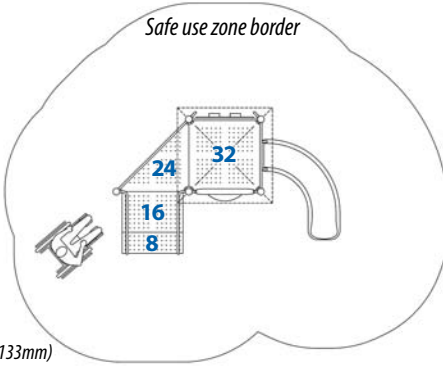

Plan-view scale: 3/32" = 1" (1 = 133mm)

Deck Heights:

- 8" 205mm
- 16" 405mm
- 24" 610mm
- 32" 815mm



Three Examples of Starting Small and Planning for Future Playground Expansion

We can produce a site specific expansion plan based on starting with any of our standard Play Areas.



9808 + A



9808 + B

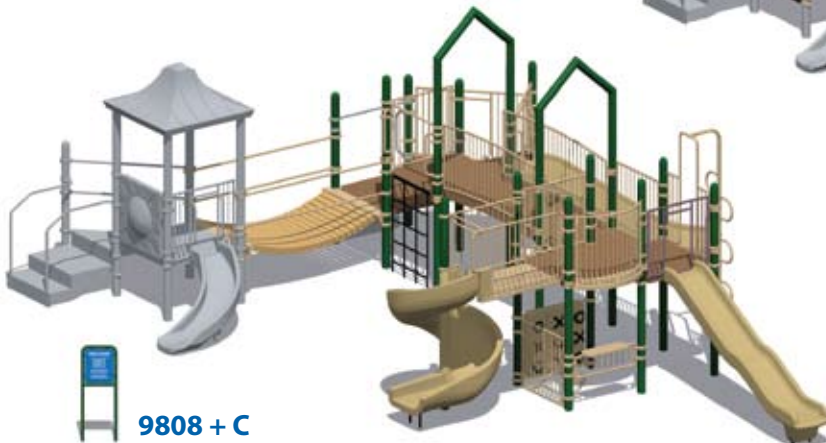

9808 + C

Start with a modest Play Area and plan for future expansion. See page 51 for another example.

Model No. 9813

Appropriate for Children 2 to 5 Years of Age.

Play Area, Equipment Only:

17' x 12' (5.2m x 3.7m)

Minimum Safe Use Zone:

29' x 24' (8.9m x 7.4m)

Accessibility Profile:

- 6 Total Play Components
- 4 Elevated Play Components (4 Accessible)
- 2 Ground Level Play Components (2 Accessible)



Colors Illustrated:

Posts: Regal Blue

Accessories: Chrome Yellow

Decks: SofDek Plastic-coated
Perforated Steel, Brown

Plastic: Yellow

Deck Heights:

- 6" 150mm
- 12" 305mm
- 18" 455mm
- 24" 610mm
- 30" 760mm
- 36" 915mm

9813 Features:

- Accessible Entrance Deck
- Baluster Wall
- Baluster Wall with Ship's Wheel
- Coil Climber
- Convex/Flat Mirror Panel
- Stepping Pads (5)
- Tot Slide Chute, Curved
- Welcome/Rules Sign

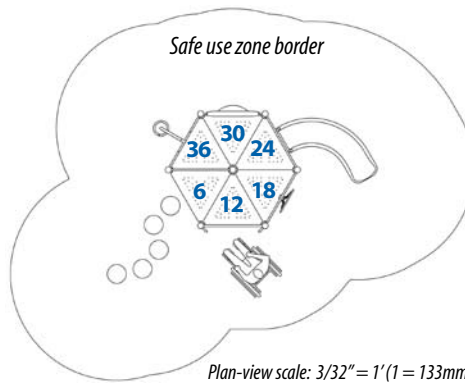

9813 Alternative Color Schemes:



A



B



C



WARNING

METAL PLAYING SURFACES CAN BECOME DANGEROUSLY HOT WHEN EXPOSED TO DIRECT SUNLIGHT. OWNERS/OPERATORS MUST WARN USERS THAT SERIOUS THERMAL BURNS MAY RESULT WHEN BARE SKIN COMES IN CONTACT WITH HOT METAL.

Play Area, Equipment Only:

17' x 20' (5.2m x 6.1m)

Minimum Safe Use Zone:

29' x 32' (8.9m x 9.8m)

Appropriate for Children 5 to 12 Years of Age.

Model No. 9817



Accessibility Profile:

11 Total Play Components

8 Elevated Play Components
(8 Accessible)

3 Ground Level Play Components
(3 Accessible)

9817 Features:

Accessible Transfer Station,
8" (21cm) Riser

Baluster Wall with Ship's Wheel

Bubble Panel

Coil Climber

Firefighter's Pole

Plastic Panel with Hole

School Bus

Spelling Panel

Spiral Slide Chute

Talk Tube

Tic-Tac-Toe

Welcome/Rules Sign

Wide Chute

Wood Roof

Colors Illustrated:

Posts: Burgundy

Accessories: Burgundy & Coffee Tan

Decks: Wood

Plastic: Tan

Deck Heights:

8" 205mm

16" 405mm

24" 610mm

32" 815mm

40" 1015mm

48" 1220mm

56" 1420mm

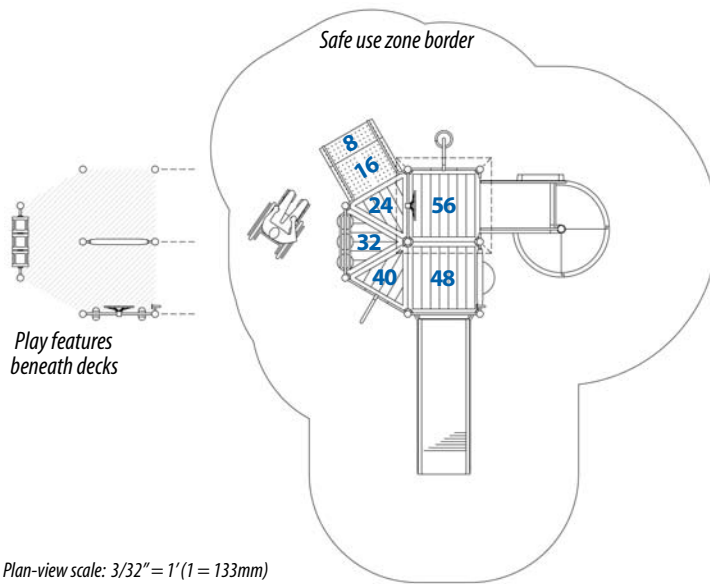

CASPAX-7™ Powder-Coating: All PipeLine “colored” metal is finished with CASPAX-7 lead-free powder coating. CASPAX-7 provides rich colors that are ultraviolet (UV) stabilized, durable and smooth— free from runs, drips or sags. The finishing process emits no volatile solvents to the atmosphere and is safe and ecologically sound.

Model No. 9821

Appropriate for Children 2 to 5 Years of Age.

Accessibility Profile:

- 5 Total Play Components
- 4 Elevated Play Components (4 Accessible)
- 1 Ground Level Play Components (1 Accessible)



Play Area, Equipment Only:

20' x 6' (6.1m x 1.9m)

Minimum Safe Use Zone:

32' x 18' (9.8m x 5.5m)

Colors Illustrated:

Posts: Regal Blue

Accessories: Red & Regal Blue

Decks: Perforated Steel, Red



9821 Features:

- Accessible Transfer Station, 8" (21cm) Riser
- Kid's Bench
- Perforated Steel Roof
- Stairs with Baluster Walls, 8" (21cm) Riser
- Talk Tube
- Vertical Ladder
- Vertical Loop Climber
- Welcome/Rules Sign
- Wide Chute, Stainless Steel with 6" (15cm) Rails

Deck Heights:

- 8" 205mm
- 16" 405mm
- 24" 610mm
- 32" 815mm
- 40" 1015mm
- 48" 1220mm

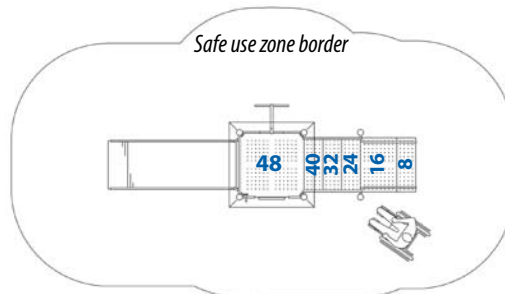

Plan-view scale: 3/32" = 1' (1 = 133mm)

9821 Alternative Color Schemes:



WARNING

METAL PLAYING SURFACES CAN BECOME DANGEROUSLY HOT WHEN EXPOSED TO DIRECT SUNLIGHT. OWNERS/OPERATORS MUST WARN USERS THAT SERIOUS THERMAL BURNS MAY RESULT WHEN BARE SKIN COMES IN CONTACT WITH HOT METAL.

Play Area, Equipment Only:

16' x 16' (4.9m x 4.9m)

Appropriate for Children 2 to 5 Years of Age.

Model No. 9826

Minimum Safe Use Zone:

28' x 28' (8.6m x 8.6m)

Accessibility Profile:

- 8 Total Play Components
- 5 Elevated Play Components (5 Accessible)
- 3 Ground Level Play Components (3 Accessible)



9826 Features:

- Accessible Transfer Station, 8" (21cm) Riser
- Bubble Panel
- Climbing Ramp
- Decorative Wall
- Decorative Wall with Ship's Wheel (2)
- Kid's Bench
- Spelling Panel
- Talk Tube
- Welcome/Rules Sign
- Wide Chute

Deck Heights:

- 8" 205mm
- 16" 405mm
- 24" 610mm
- 32" 815mm
- 40" 1015mm
- 48" 1220mm

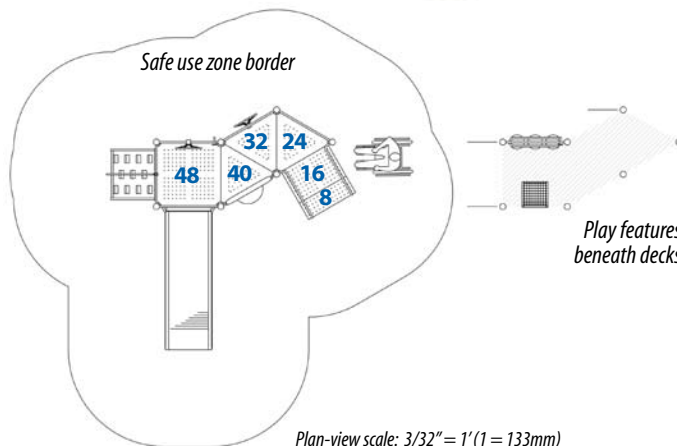

Colors Illustrated:

- Posts:** Brown
- Accessories:** Coffee Tan
- Decks:** SofDek Plastic-coated Perforated Steel, Brown
- Plastic:** Tan

Examples of Twenty of Over 200 Available CASPAX-7™ Designer Powder-Coating Colors

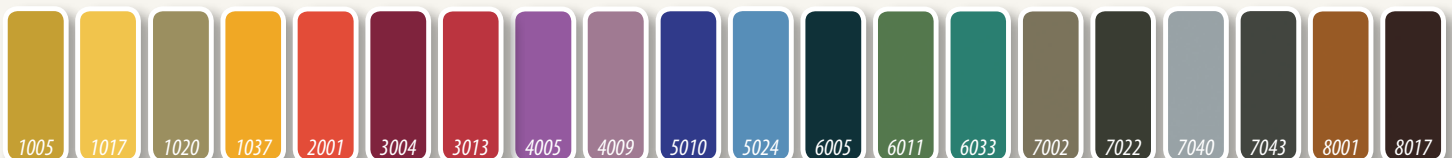

Due to variations in the printing process the colors shown above are only a guide to the actual powder-coating colors.

Model No. 9830

Appropriate for Children 5 to 12 Years of Age.

Play Area, Equipment Only:

18' x 19' (5.5m x 5.8m)

Minimum Safe Use Zone:

30' x 31' (9.2m x 9.5m)

Accessibility Profile:

- 7 Total Play Components
- 5 Elevated Play Components (5 Accessible)
- 2 Ground Level Play Components (2 Accessible)

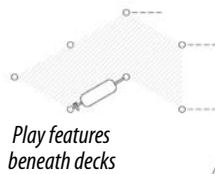

Play features beneath decks

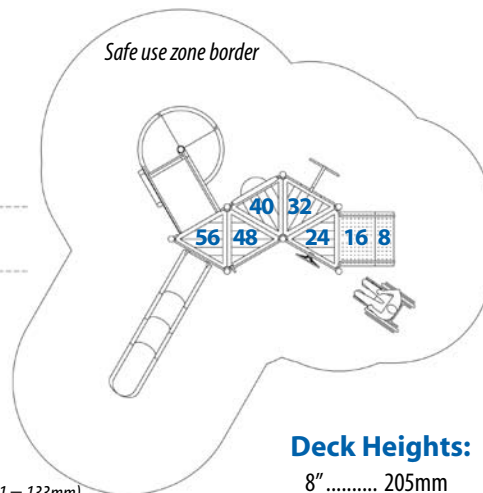

Plan-view scale: 3/32" = 1' (1 = 133mm)

Deck Heights:

8"	205mm
16"	405mm
24"	610mm
32"	815mm
40"	1015mm
48"	1220mm
56"	1420mm

9830 Features:

- Accessible Transfer Station, 8" (21cm) Riser
- Baluster Wall
- Baluster Wall with Ship's Wheel
- Bubble Panel
- Slide Chute
- Spiral Slide Chute
- Storefront Countertop
- Talk Tube
- Vertical Loop Climber
- Welcome/Rules Sign

Colors Illustrated:

- Posts:** Coffee Tan
- Accessories:** Regal Blue
- Decks:** Wood
- Plastic:** Tan



PipeLine Thick-walled Schedule 40 Pipe PipeLine playground equipment uses thick-walled 4-1/2" (114mm) diameter (shown actual thickness at left in blue) Schedule 40 steel pipe posts rather than thin-walled tubing (shown actual thickness at left in red). Smoothly formed aluminum collars are bolted and pinned using stainless steel hardware. The PipeLine connection system provides an unobtrusive child-friendly yet rigid connection between posts, rails and accessories.

WARNING

METAL PLAYING SURFACES CAN BECOME DANGEROUSLY HOT WHEN EXPOSED TO DIRECT SUNLIGHT. OWNERS/OPERATORS MUST WARN USERS THAT SERIOUS THERMAL BURNS MAY RESULT WHEN BARE SKIN COMES IN CONTACT WITH HOT METAL.

Play Area, Equipment Only:

20' x 15' (6.1m x 4.6m)

Minimum Safe Use Zone:

32' x 27' (9.8m x 8.3m)

Play Area, Spring Rider Only:

3' x 2' (1.0m x 0.7m)

Minimum Safe Use Zone:

15' x 14' (4.6m x 4.3m)

Appropriate for Children 2 to 5 Years of Age.

Model No. 9834

Accessibility Profile:

- 10 Total Play Components**
- 7 Elevated Play Components (7 Accessible)
- 3 Ground Level Play Components (3 Accessible)

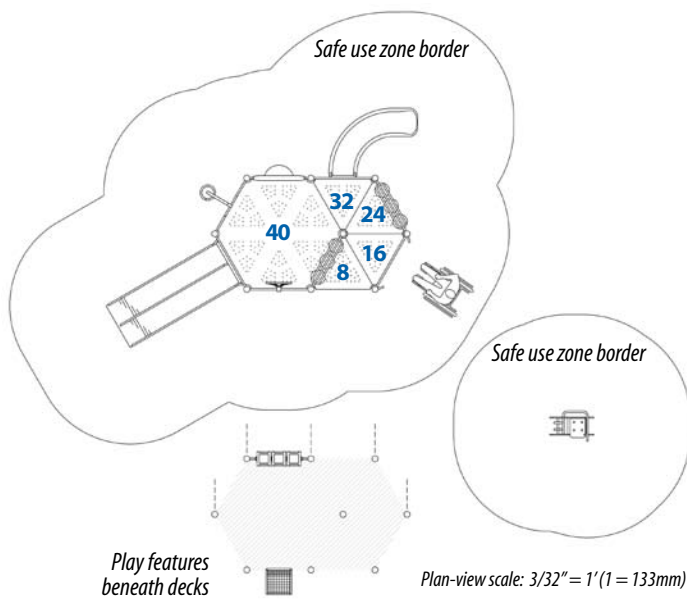
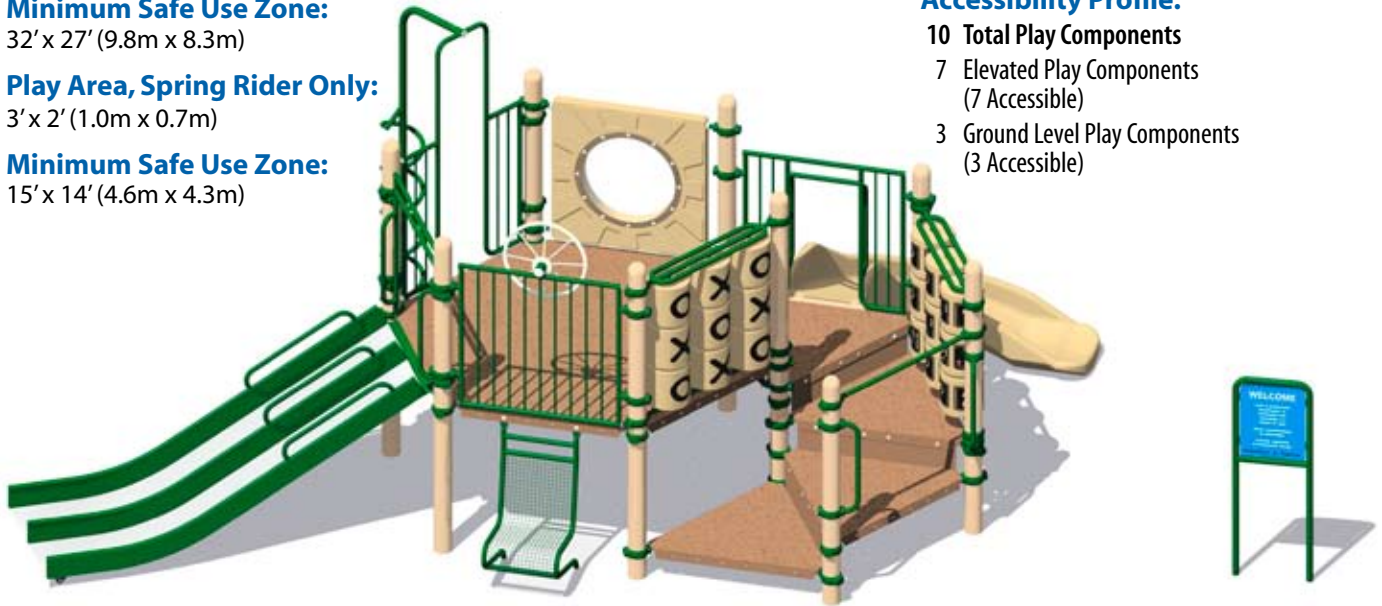

9834 Features:

- Accessible Entrance Deck
- Accessible Spring Rider
- Addition Panel
- Baluster Wall with Ship's Wheel
- Bubble Panel
- Coil Climber
- Kid's Bench
- Spelling Panel
- Tic-Tac-Toe
- Tot Slide Chute, Curved
- Welcome/Rules Sign
- Wide Chute with Center Rail, Stainless Steel with 6" (15cm) Rails

Colors Illustrated:

- Posts:** Coffee Tan
- Accessories:** Evergreen
- Decks:** SofDek Plastic-coated
Perforated Steel, Brown
- Plastic:** Tan

Deck Heights:

- 8" 205mm
- 16" 405mm
- 24" 610mm
- 32" 815mm
- 40" 1015mm



To better withstand the rigors of tough city life, most PipeLine Play Areas can be specified with all metal accessories rather than ubiquitous plastic seen on our competitors' offerings. When combined with tough Schedule 40 steel pipe and stainless steel chutes the result is a truly "Urban Fit" playground.

Model No. 9839

Appropriate for Children 2 to 5 Years of Age.

Play Area, Equipment Only:

25' x 19' (7.7m x 5.8m)

Minimum Safe Use Zone:

37' x 31' (11.3m x 9.5m)

Accessibility Profile:

15 Total Play Components

- 9 Elevated Play Components
(9 Accessible)
- 6 Ground Level Play Components
(6 Accessible)



9839 Features:

- Accessible Entrance Deck
- Accessible Transfer Station,
8" (21cm) Riser
- Baluster Wall
- Baluster Wall with Ship's Wheel
- Bubble Panel
- Coil Climber
- Convex/Flat Mirror Panel
- Kid's Bench
- Maze Panel
- Roof
- Spelling Panel
- Storefront Countertop
- Talk Tube
- Tic-Tac-Toe
- Tot Slide Chute, Curved
- Tunnel Crawl, Clear Plastic
- Vertical Loop Climber
- Welcome/Rules Sign
- Wide Slide Chute, Wave/Slalom

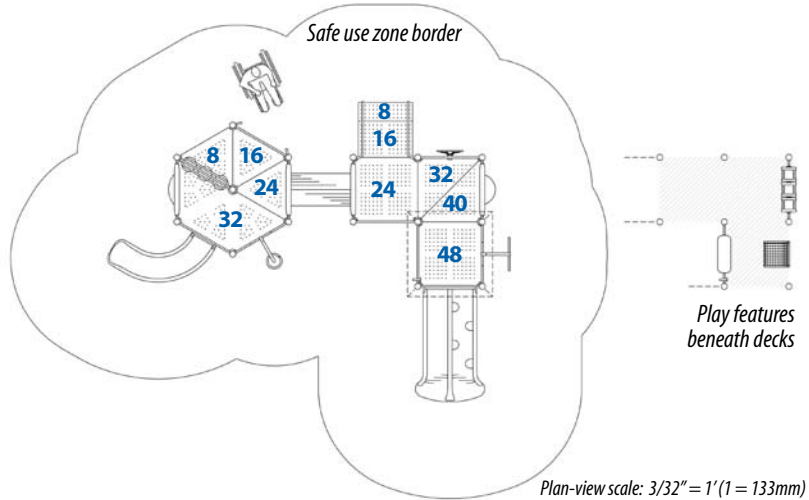

Colors Illustrated:

Posts: Coffee Tan

Accessories: Evergreen

Decks: SofDek Plastic-coated
Perforated Steel, Brown

Plastic: Tan

Deck Heights:

8"	205mm
16"	405mm
24"	610mm
32"	815mm
40"	1015mm
48"	1220mm



WARNING

METAL PLAYING SURFACES CAN BECOME DANGEROUSLY HOT WHEN EXPOSED TO DIRECT SUNLIGHT. OWNERS/OPERATORS MUST WARN USERS THAT SERIOUS THERMAL BURNS MAY RESULT WHEN BARE SKIN COMES IN CONTACT WITH HOT METAL.

Play Area, Equipment Only:
24' x 14' (7.4m x 4.3m)

Appropriate for Children 2 to 5 Years of Age.

Model No. 9843

Minimum Safe Use Zone:
36' x 26' (11.0m x 8.0m)

Accessibility Profile:

- 12 Total Play Components
- 7 Elevated Play Components (7 Accessible)
- 5 Ground Level Play Components (5 Accessible)

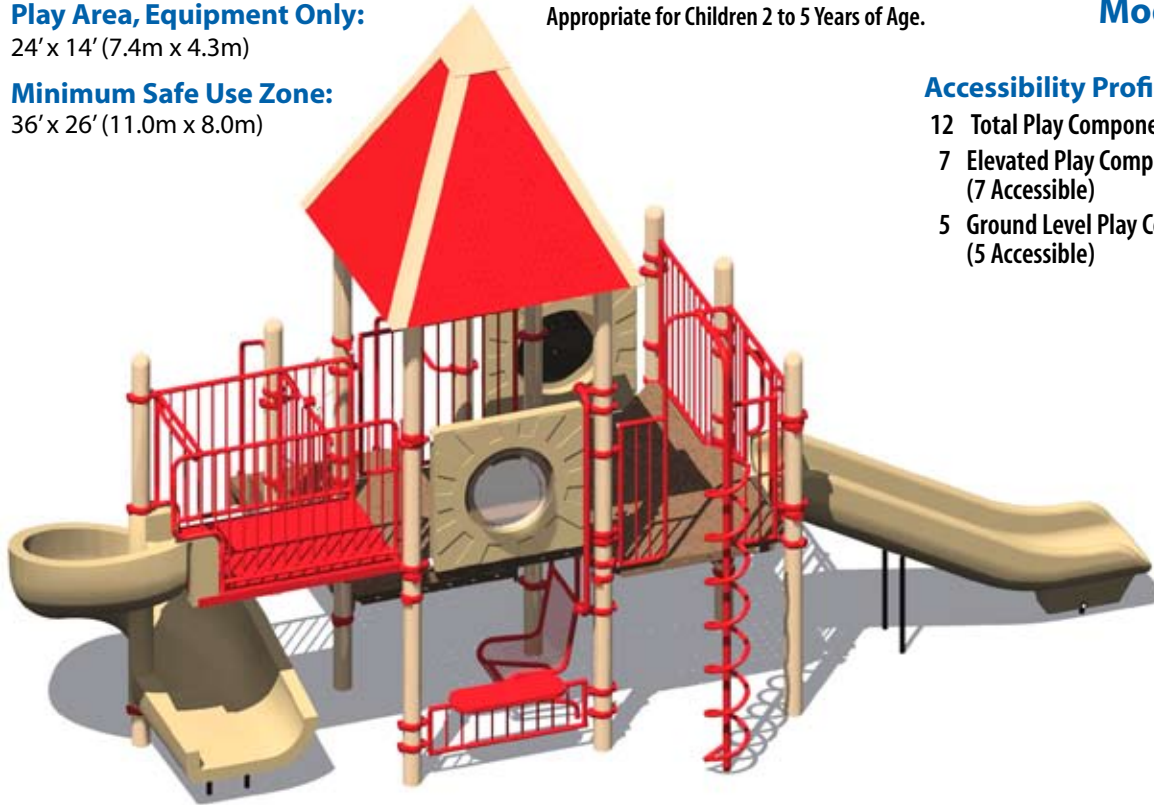

9843 Features:

- Abacus
- Accessible Transfer Station, 8" (21cm) Riser
- Baluster Wall (2)
- Baluster Wall with Ship's Wheel
- Bubble Panel
- Coil Climber
- Convex/Flat Mirror Panel
- Kid's Bench
- Perforated Steel Roof
- Slide Chute
- Spelling Panel
- Spiral Slide Chute
- Storefront Countertop
- Talk Tube
- Welcome/Rules Sign

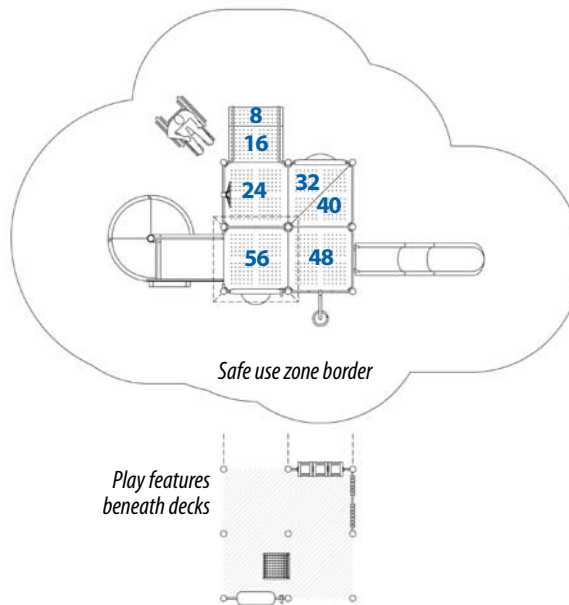

Plan-view scale: 3/32" = 1' (1 = 133mm)

Colors Illustrated:

- Posts:** Coffee Tan
- Accessories:** Coffee Tan & Red
- Decks:** SofDek Plastic-coated Perforated Steel, Brown
- Plastic:** Tan

Deck Heights:

- 8" 205mm
- 16" 405mm
- 24" 610mm
- 32" 815mm
- 40" 1015mm
- 48" 1220mm
- 56" 1420mm



CASPAX™ Standard Powder-Coating Colors

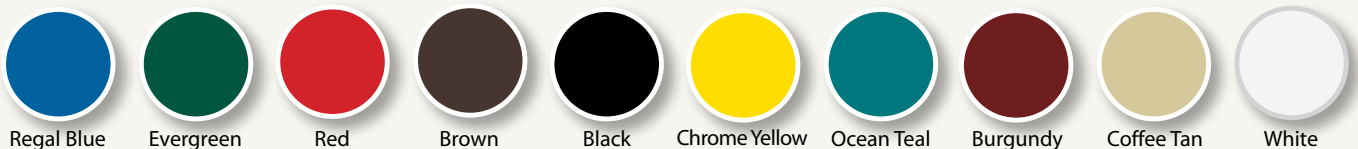

Due to variations in the printing process the colors shown above are only a guide to the actual powder-coating colors.

Model No. 9847

Appropriate for Children 5 to 12 Years of Age.

Play Area, Equipment Only:

43' x 20' (13.2m x 6.1m)

Accessibility Profile:

- 14 Total Play Components
- 10 Elevated Play Components
(6 Accessible)
- 4 Ground Level Play Components
(4 Accessible)

Minimum Safe Use Zone:

55' x 32' (16.8m x 9.8m)

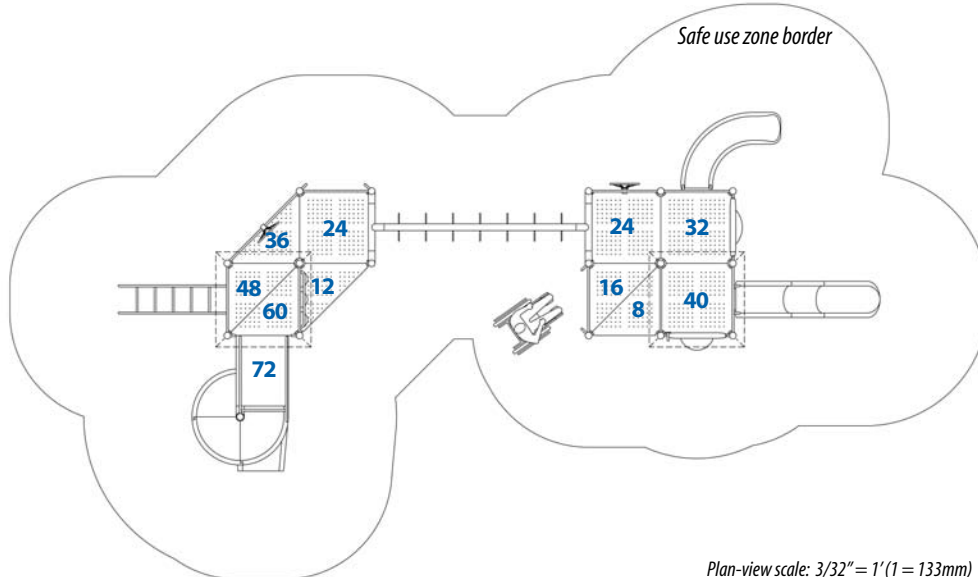
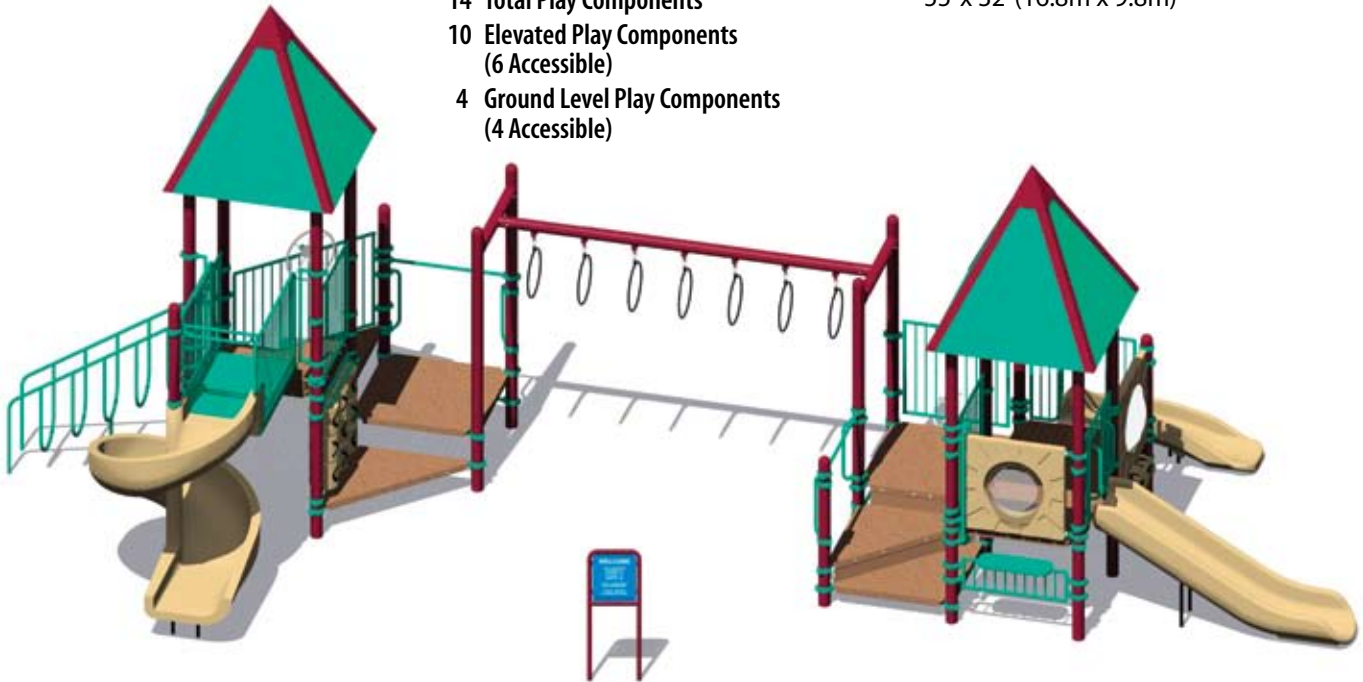

9847 Features:

- Accessible Entrance Deck
- Baluster Wall (2)
- Baluster Wall with Ship's Wheel (2)
- Bubble Panel
- Convex/Flat Mirror Panel
- Loop Climber with Handrails
- Perforated Steel Roof (2)
- Slide Chute
- Spelling Panel
- Spiral Slide Chute
- Storefront Countertop
- Super Ring Beam, 12' (366cm)
- Talk Tube
- Tic-Tac-Toe
- Tot Slide Chute, Curved
- Welcome/Rules Sign

Colors Illustrated:

Posts: Burgundy

Accessories: Burgundy & Ocean Teal

Decks: SofDek Plastic-coated Perforated Steel, Brown

Plastic: Tan

Deck Heights:

8" 205mm	32" 815mm	60" 1525mm
12" 305mm	36" 915mm	72" 1830mm
16" 405mm	40" 1015mm	
24" 610mm	48" 1220mm	

Plan-view scale: 3/32" = 1' (1 = 133mm)



Model No. 9856

Appropriate for Children 2 to 5 Years of Age.

Play Area, Equipment Only:

30' x 14' (9.2m x 4.3m)

Minimum Safe Use Zone:

42' x 26' (12.9m x 8.0m)

Play Area, Spring Rider Only:

3' x 2' (1.0m x 0.7m)

Minimum Safe Use Zone:

15' x 14' (4.6m x 4.3m)

Accessibility Profile:

- 12 Total Play Components
- 8 Elevated Play Components (8 Accessible)
- 4 Ground Level Play Components (4 Accessible)



9856 Features:

- Abacus
- Accessible Spring Rider
- Accessible Transfer Station, 8" (21cm) Riser
- Baluster Wall (2)
- Baluster Wall with Ship's Wheel
- Coil Climber
- Convex/Flat Mirror Panel
- Decorative Arch (3)
- Funnel Net Climber
- Spelling Panel
- Tic-Tac-Toe
- Tube Chute
- Vertical Cargo Net
- Welcome/Rules Sign
- Wide Chute

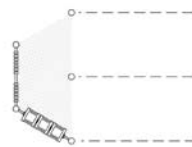

Play features beneath decks

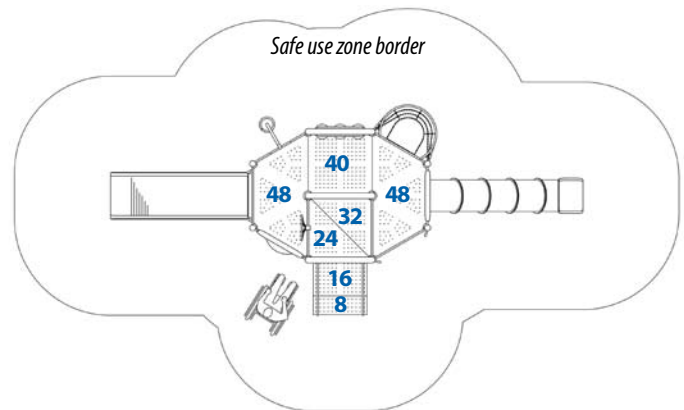

Colors Illustrated:

- Posts:** Evergreen
- Accessories:** Coffee Tan
- Decks:** SofDek Plastic-coated Perforated Steel, Brown
- Plastic:** Tan



Deck Heights:

- 8" 205mm
- 16" 405mm
- 24" 610mm
- 32" 815mm
- 40" 1015mm
- 48" 1220mm

Plan-view scale: 3/32" = 1' (1 = 133mm)



Model No. 9865

Appropriate for Children 5 to 12 Years of Age.

Play Area, Equipment Only:

25' x 29' (7.7m x 8.9m)

Minimum Safe Use Zone:

37' x 41' (11.3m x 12.5m)

Accessibility Profile:

- 14 Total Play Components
- 9 Elevated Play Components
(9 Accessible)
- 5 Ground Level Play Components
(5 Accessible)



Colors Illustrated:

Posts: Coffee Tan

Accessories: Evergreen

Decks: SofDek Plastic-coated
Perforated Steel, Brown

Plastic: Tan

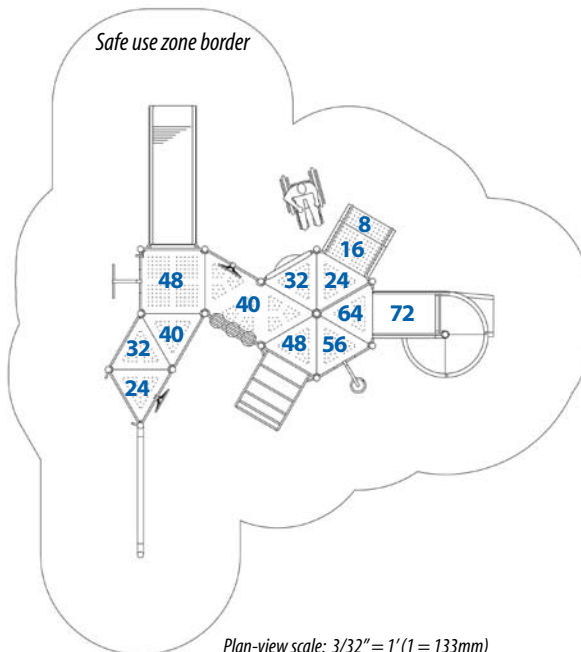
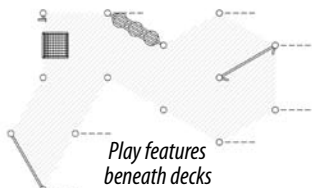

9865 Features:

- Accessible Transfer Station, 8" (21cm) Riser
- Arch Climber
- Baluster Wall (3)
- Baluster Wall with Ship's Wheel (2)
- Cargo Net Climber
- Coil Climber
- Convex/Flat Mirror Panel
- Kid's Bench
- Spelling Panel
- Spiral Slide Chute
- Talk Tube
- Tic-Tac-Toe
- Vertical Loop Climber
- Welcome/Rules Sign
- Wide Chute



Rotationally-molded Plastic Accessories PipeLine, TimberForm and RePlay plastic accessories are manufactured from hot-compounded medium density polyethylene (MDPE). Hot-compounding assures uniform coloration within each part and from part to part and maximum UV resistance. The final wall-thickness of our rotationally-molded plastic accessories (shown in yellow at left) is 50% thicker (both shown actual thickness) than the industry standard adding to strength, durability and long useful life. Our plastics are free of PVC and phthalates.

WARNING

METAL PLAYING SURFACES CAN BECOME DANGEROUSLY HOT WHEN EXPOSED TO DIRECT SUNLIGHT. OWNERS/OPERATORS MUST WARN USERS THAT SERIOUS THERMAL BURNS MAY RESULT WHEN BARE SKIN COMES IN CONTACT WITH HOT METAL.

Play Area, Equipment Only:

28' x 20' (8.6m x 6.1m)

Appropriate for Children 5 to 12 Years of Age.

Model No. 9869

Minimum Safe Use Zone:

40' x 32' (12.2m x 9.8m)

Accessibility Profile:

11 Total Play Components

- 7 Elevated Play Components (7 Accessible)
- 4 Ground Level Play Components (4 Accessible)

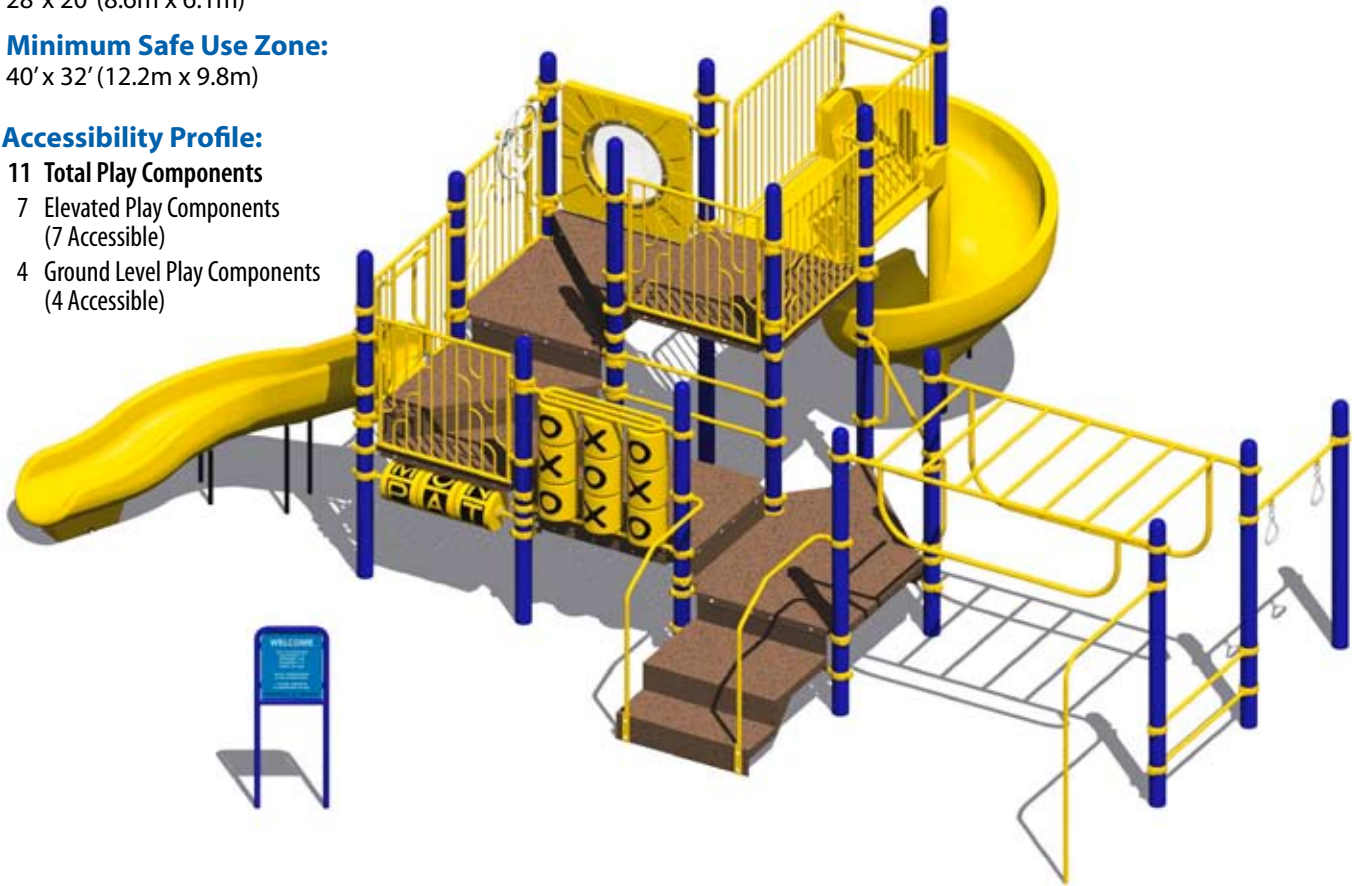

9869 Features:

- Accessible Entrance Deck
- Accessible Ring Pull
- Accessible Transfer Station, 8" (21cm) Riser
- Addition Panel
- Bubble Panel
- Chinning Bar
- Decorative Wall (3)
- Decorative Wall with Ship's Wheel
- Overhead Safety Ladder
- Slide Chute, Curved
- Spelling Panel
- Spiral Slide Chute
- Talk Tube
- Tic-Tac-Toe
- Welcome/Rules Sign

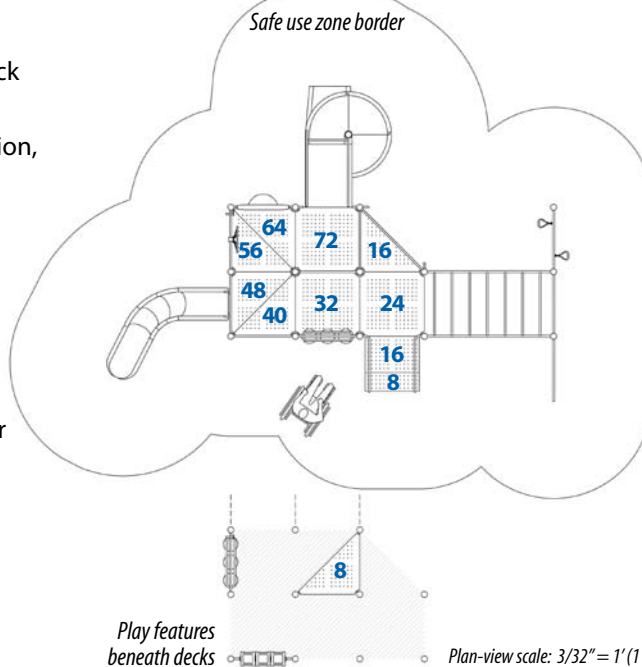

Colors Illustrated:

Posts: Regal Blue

Accessories: Chrome Yellow

Decks: SofDek Plastic-coated Perforated Steel, Brown

Plastic: Yellow

Deck Heights:

- 8" 205mm
- 16" 405mm
- 24" 610mm
- 32" 815mm
- 40" 1015mm
- 48" 1220mm
- 56" 1420mm
- 64" 1625mm
- 72" 1830mm



PipeLine Design Note: Keep in mind that PipeLine play systems are modular in design and that most accessories are interchangeable. We encourage choosing features from several Play Areas and melding them into a unique design.

Model No. 9873

Appropriate for Children 5 to 12 Years of Age.

Play Area, Equipment Only:

36' x 32' (11.0m x 9.8m)

Minimum Safe Use Zone:

48' x 44' (14.7m x 13.5m)

Accessibility Profile:

- 13 Total Play Components
- 8 Elevated Play Components (8 Accessible)
- 5 Ground Level Play Components (5 Accessible)

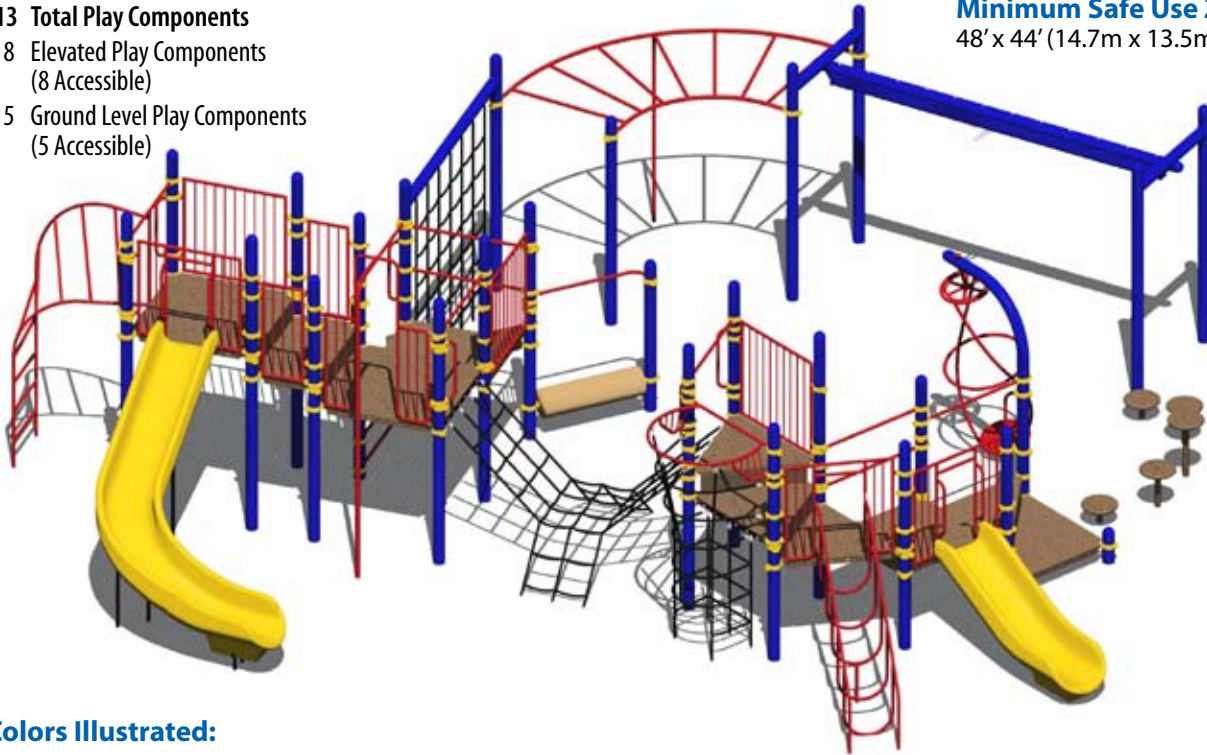

Colors Illustrated:

- Posts:** Regal Blue
- Accessories:** Red
- Decks:** SofDek Plastic-coated Perforated Steel, Brown
- Plastic:** Yellow

9873 Features:

- Accessible Entrance Deck
- Baluster Wall (5)
- Cargo Net Climber
- CrossClimber Cargo Net
- Curved Overhead Climber
- Firefighter's Pole
- Funnel Net Climber
- Log Roll
- Loop Climber
- Slide Chute
- Slide Chute, Curved
- Spiral Spinner
- Stepping Pad (5)
- Track Ride, 12' (366cm)
- Twisting Climber
- Welcome/Rules Sign

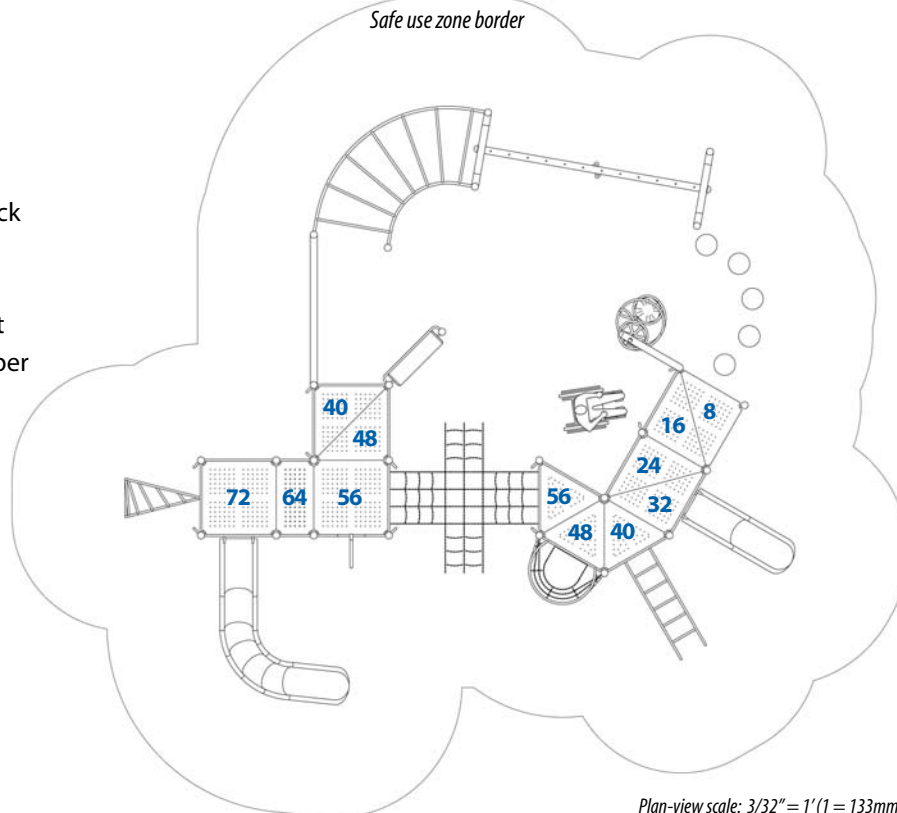

Deck Heights:

- 8" 205mm
- 16" 405mm
- 24" 610mm
- 32" 815mm
- 40" 1015mm
- 48" 1220mm
- 56" 1420mm
- 64" 1625mm
- 72" 1830mm

Plan-view scale: 3/32" = 1' (1 = 133mm)



WARNING

METAL PLAYING SURFACES CAN BECOME DANGEROUSLY HOT WHEN EXPOSED TO DIRECT SUNLIGHT. OWNERS/OPERATORS MUST WARN USERS THAT SERIOUS THERMAL BURNS MAY RESULT WHEN BARE SKIN COMES IN CONTACT WITH HOT METAL.

Play Area, Equipment Only:

30' x 21' (9.2m x 6.5m)

Appropriate for Children 2 to 5 Years of Age.

Model No. 9878

Minimum Safe Use Zone:

42' x 33' (12.9m x 10.1m)

Colors Illustrated:

Posts: Ocean Teal

Accessories: Ocean Teal

Decks: SofDek Plastic-coated
Perforated Steel, Brown

Plastic: Tan

Accessibility Profile:

- 14 Total Play Components
- 10 Elevated Play Components
(10 Accessible)
- 4 Ground Level Play Components
(4 Accessible)



9878 Features:

- Abacus
- Accessible Transfer Station, 8" (21cm) Riser (2)
- Addition Panel
- Arch Climber
- Arch Ring Climber
- Baluster Wall
- Baluster Wall with Ship's Wheel
- Coil Climber
- Convex/Flat Mirror Panel
- CrossClimber Cargo Net
- Decorative Arch (2)
- Kid's Bench
- Spelling Panel
- Tube Chute, Curved
- Vertical Loop Climber
- Welcome/Rules Sign
- Wide Slide Chute, Wave/Slalom

Play features
beneath decks



Safe use zone border

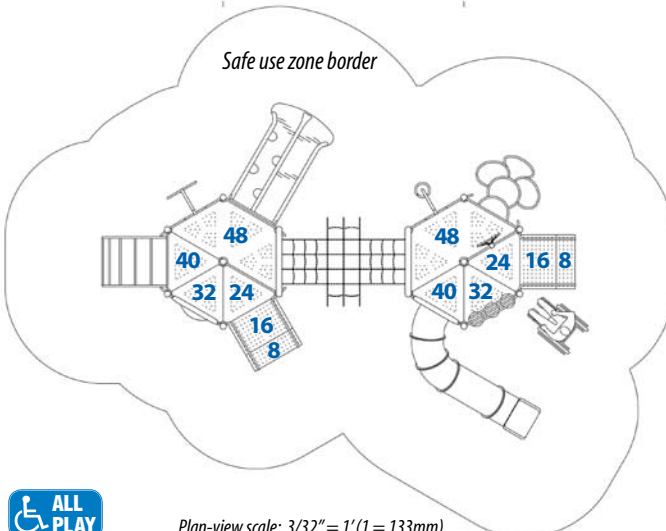

Deck Heights:

- 8" 205mm
- 16" 405mm
- 24" 610mm
- 32" 815mm
- 40" 1015mm
- 48" 1220mm



Plan-view scale: 3/32" = 1' (1 = 133mm)

Model No. 9882

Appropriate for Children 5 to 12 Years of Age.

Play Area, Equipment Only:

33' x 28' (10.1m x 8.6m)

Minimum Safe Use Zone:

45' x 40' (13.8m x 12.2m)

Accessibility Profile:

- 18 Total Play Components
- 13 Elevated Play Components
(13 Accessible)
- 5 Ground Level Play Components
(5 Accessible)

Colors Illustrated:

- Posts:** Coffee Tan
- Accessories:** Burgundy
- Decks:** Wood
- Plastic:** Yellow

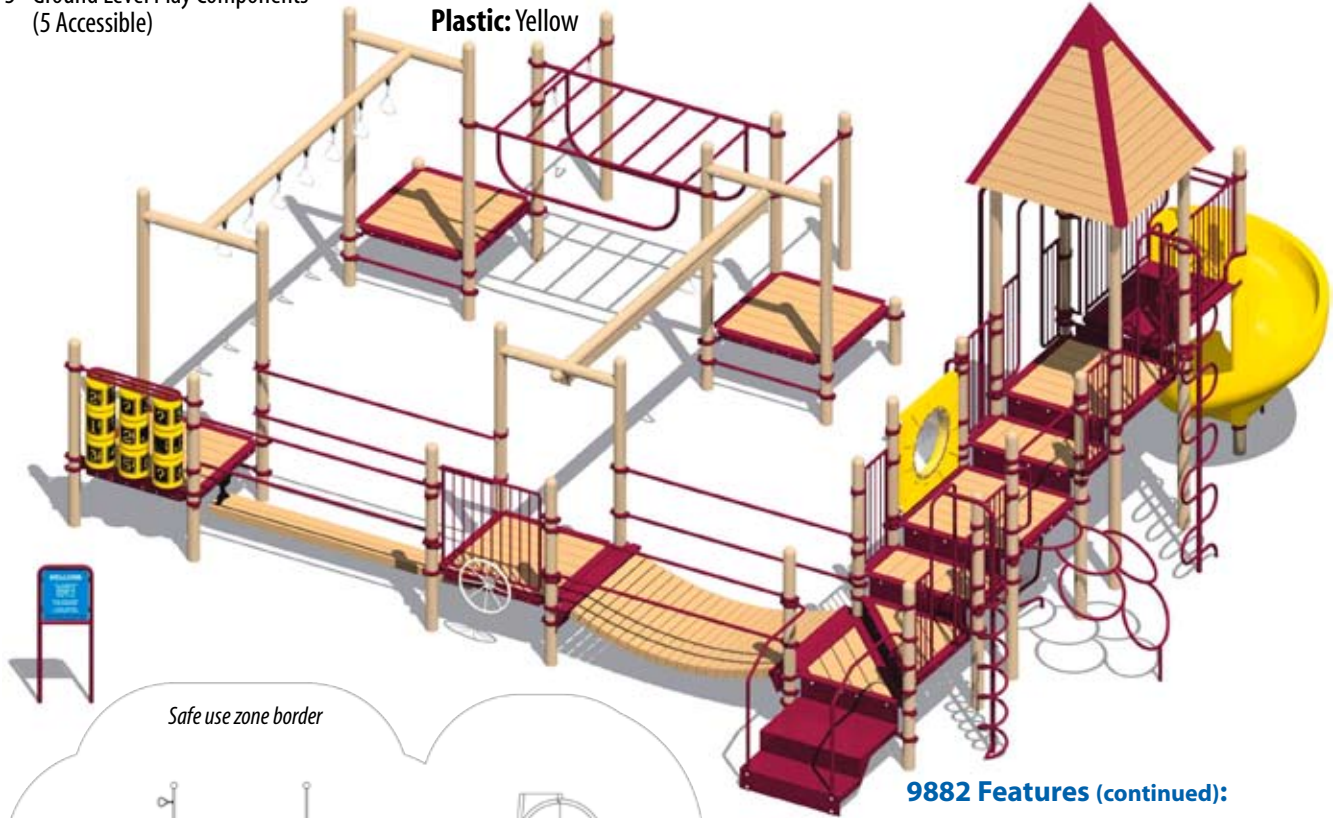

Safe use zone border

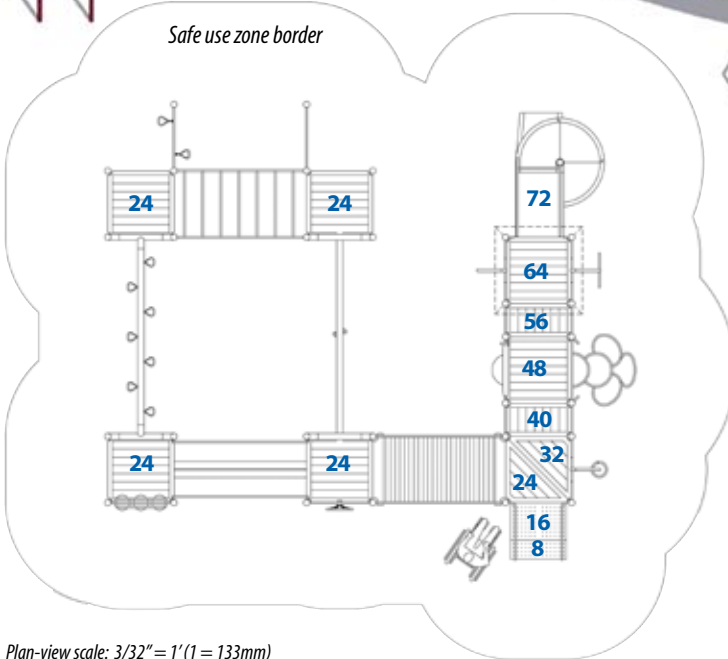

9882 Features (continued):

- Arch Ring Climber
- Baluster Wall (4)
- Baluster Wall with Ship's Wheel
- Bubble Panel
- Chinning Bar
- Clatter Bridge, Wood with Handrails
- Coil Climber
- Firefighter's Pole
- Kid's Bench
- Moving Bridgeway
- Overhead Safety Ladder
- Ring Beam 12' (366cm)
- Spiral Slide Chute
- Storefront Countertop
- Talk Tube
- Track Ride 12' (366cm)
- Vertical Loop Climber
- Welcome/Rules Sign
- Wood Roof
- Welcome/Rules Sign



Deck Heights:

8"	205mm	48"	1220mm
16"	405mm	56"	1420mm
24"	610mm	64"	1625mm
32"	815mm	72"	1830mm
40"	1015mm		

9882 Features:

- Accessible Ring Pull
- Accessible Transfer Station,
8" (21cm) Riser
- Addition Panel



WARNING

METAL PLAYING SURFACES CAN BECOME DANGEROUSLY HOT WHEN EXPOSED TO DIRECT SUNLIGHT. OWNERS/OPERATORS MUST WARN USERS THAT SERIOUS THERMAL BURNS MAY RESULT WHEN BARE SKIN COMES IN CONTACT WITH HOT METAL.

Play Area, Equipment Only:

35' x 22' (10.7m x 6.8m)

Appropriate for Children 5 to 12 Years of Age.

Model No. 9886

Minimum Safe Use Zone:

47' x 34' (14.4m x 10.4m)

Accessibility Profile:

- 13 Total Play Components
- 10 Elevated Play Components (6 Accessible)
- 3 Ground Level Play Components (3 Accessible)

Colors Illustrated:

Posts: Coffee Tan

Accessories: Regal Blue

Decks: SofDek Plastic-coated Perforated Steel, Brown

Plastic: Tan

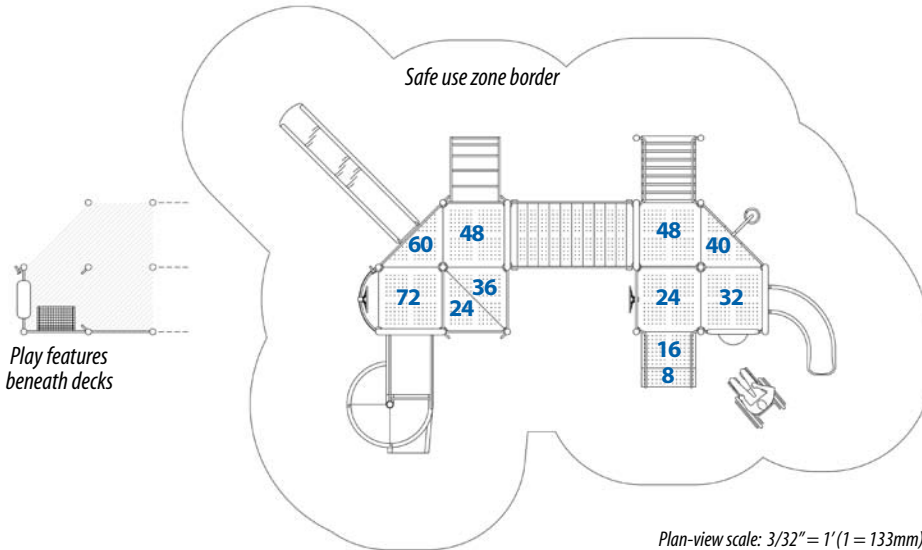
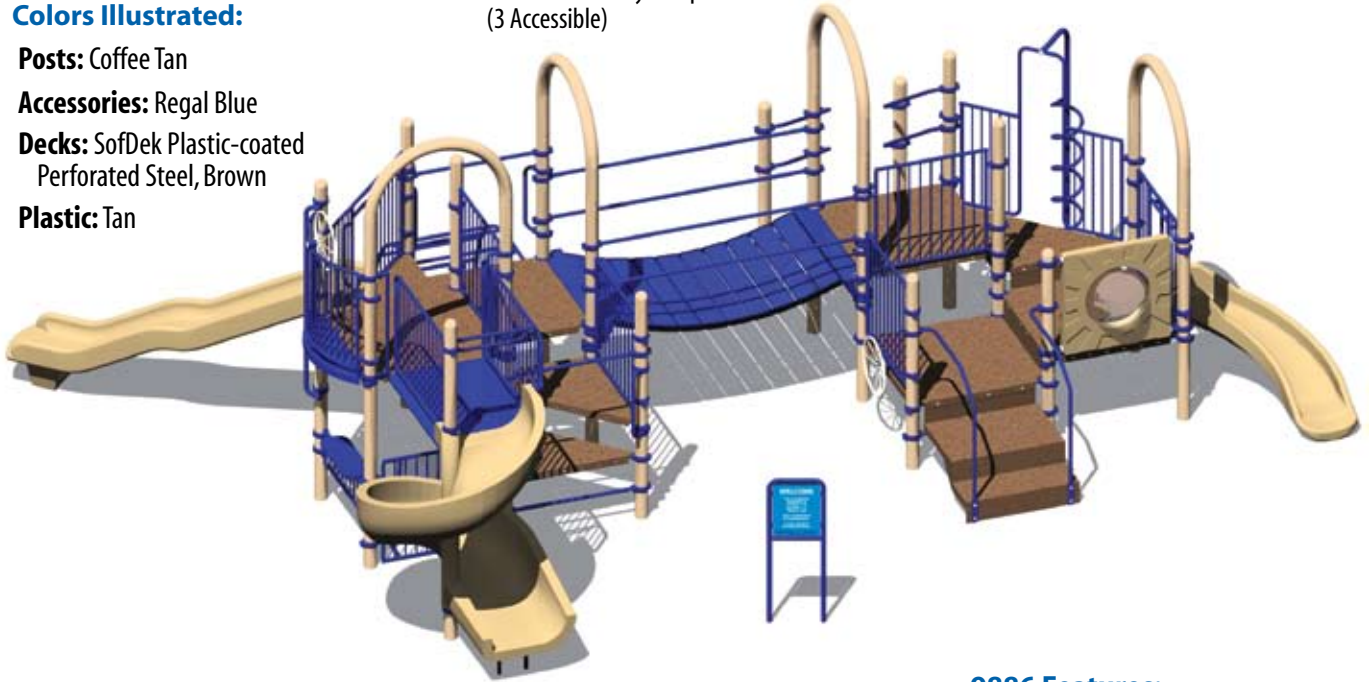

Deck Heights:

8" 205mm	40" 1015mm
16" 405mm	48" 1220mm
24" 610mm	60" 1525mm
32" 815mm	72" 1830mm
36" 915mm	

9886 Features:

- Accessible Transfer Station, 8" (21cm) Riser
- Arch Climber
- Baluster Wall (3)
- Baluster Wall with Ship's Wheel
- Bubble Panel
- Coil Climber
- Decorative Arch (4)
- Grade Climber, Steel with Handrails
- Kid's Bench
- Lookout Platform with Ship's Wheel
- Spiral Slide Chute
- Storefront Countertop
- Suspension Bridge, Perforated Steel with Handrails
- Talk Tube
- Tot Slide Chute, Curved
- Wave Chute
- Welcome/Rules Sign



Need CAD details or specifications? Contact us at HQ@timberform.com

Model No. 9891

Appropriate for Children 5 to 12 Years of Age.

Play Area, Equipment Only:

36' x 37' (11.0m x 11.3m)

Minimum Safe Use Zone:

48' x 49' (14.7m x 15.0m)

Accessibility Profile:

- 20 Total Play Components
- 13 Elevated Play Components
(9 Accessible)
- 7 Ground Level Play Components
(7 Accessible)



Colors Illustrated:

- Posts:** Coffee Tan
- Accessories:** Coffee Tan & Red
- Decks:** SofDek Plastic-coated Perforated Steel, Brown
- Plastic:** Tan

Safe use zone border

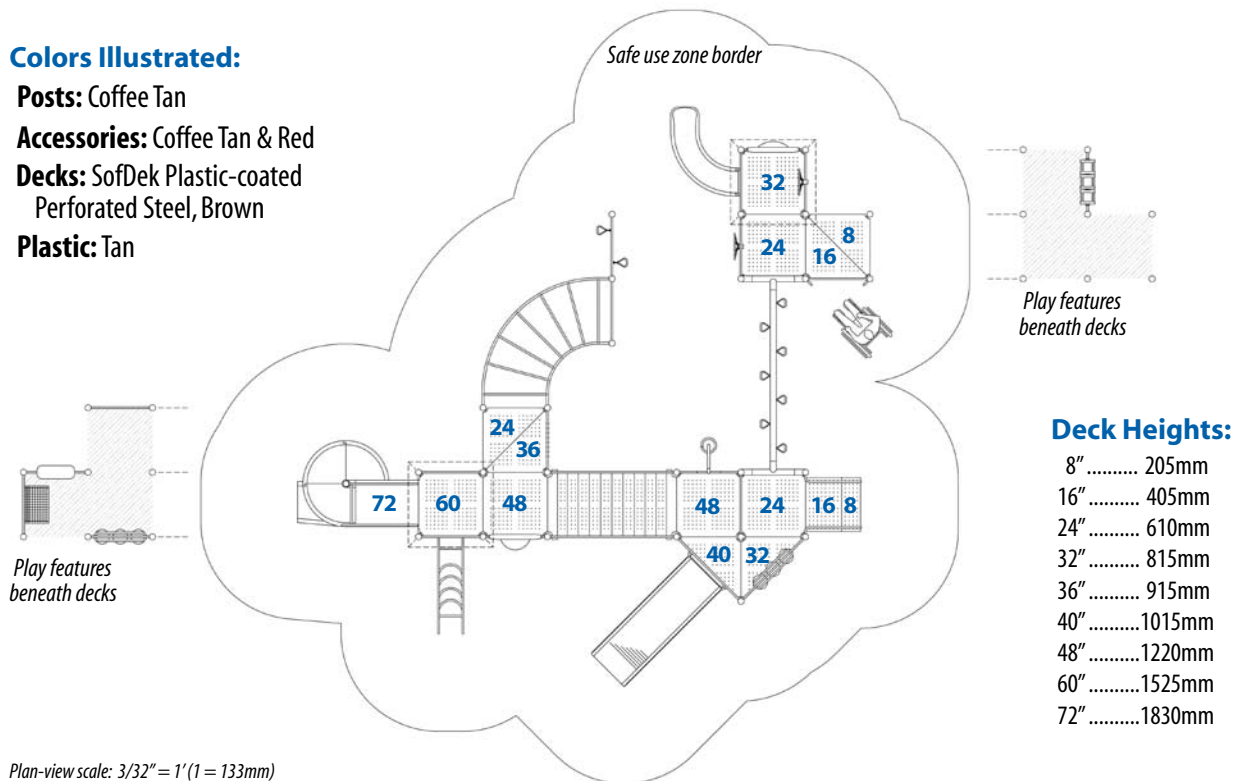

Deck Heights:

- 8" 205mm
- 16" 405mm
- 24" 610mm
- 32" 815mm
- 36" 915mm
- 40" 1015mm
- 48" 1220mm
- 60" 1525mm
- 72" 1830mm

Plan-view scale: 3/32" = 1' (1 = 133mm)





WARNING

METAL PLAYING SURFACES CAN BECOME DANGEROUSLY HOT WHEN EXPOSED TO DIRECT SUNLIGHT. OWNERS/OPERATORS MUST WARN USERS THAT SERIOUS THERMAL BURNS MAY RESULT WHEN BARE SKIN COMES IN CONTACT WITH HOT METAL.

PipeLine®

Model No. 9891 in Three Phases

9891 Phase 1, 2 & 3:

Play Area, Equipment Only:

36' x 37' (11.0m x 11.3m)

Minimum Safe Use Zone:

48' x 49' (14.7m x 15.0m)

9891 Phase 1 & 2:

Play Area, Equipment Only:

18' x 37' (5.5m x 11.3m)

Minimum Safe Use Zone:

30' x 49' (9.2m x 15.0m)

9891 Phase 1:

Play Area, Equipment Only:

13' x 27' (4.0m x 8.3m)

Minimum Safe Use Zone:

25' x 39' (7.7m x 11.9m)

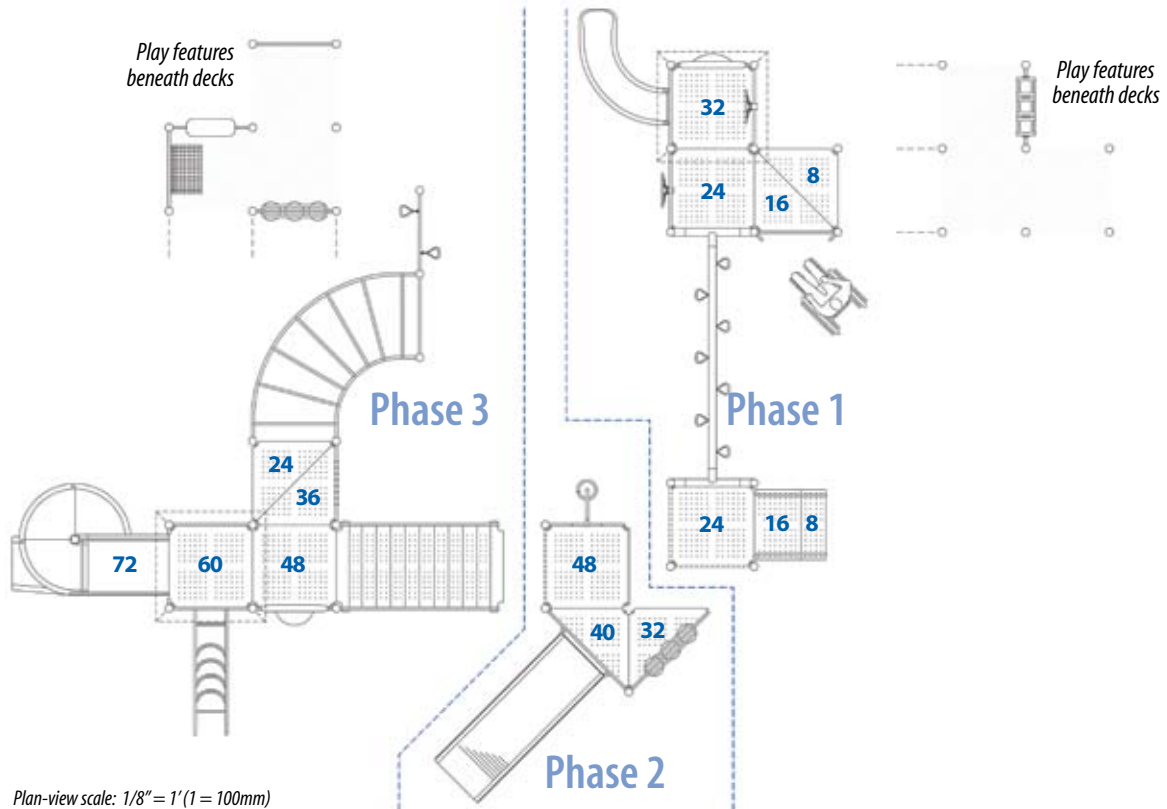

9891 Features, Phase 3:

- Accessible Ring Pull
- Addition Panel
- Baluster Wall (1 from Phase 2)
- Bubble Panel
- Chime Panel
- Curved Overhead Ladder
- Kid's Bench
- Loop Climber
- Perforated Steel Roof
- Spiral Slide Chute
- Storefront Countertop
- Suspension Bridge, Perforated Steel, with Baluster Walls

9891 Features, Phase 2:

- Baluster Wall (2 from Phase 1)
- Coil Climber
- Tic-Tac-Toe
- Wide Chute

9891 Features, Phase 1:

- Accessible Entrance Deck
- Accessible Transfer Station, 8" (21cm) Riser
- Baluster Wall (2)
- Baluster Wall with Ship's Wheel (2)
- Convex/Flat Mirror Panel
- Perforated Steel Roof
- Ring Beam, 12' (366cm)
- Spelling Panel
- Tot Slide Chute, Curved
- Welcome/Rules Sign



Knowledgeable consultants are available to assist the professional designer or recreator in creating custom phased Play Areas of any size. Contact us or your nearby representative for more information.

Model No. 9895

Appropriate for Children 5 to 12 Years of Age.

Play Area, Equipment Only:

37' x 33' (11.3m x 10.1m)

Minimum Safe Use Zone:

45' x 45' (13.8m x 13.8m)



Accessibility Profile:

- 13 Total Play Components
- 11 Elevated Play Components
(11 Accessible)
- 2 Ground Level Play Components
(2 Accessible)

9895 Features:

- Accessible Deck Ramp with Handrails (2)
- Accessible Entrance Deck (2)
- Accessible Grade Ramp with Handrails
- Accessible Ring Pull
- Accessible Tube Chute, Curved
- Accessible Wide Chute
- Addition Panel
- Baluster Wall with Ship's Wheel (2)
- Bubble Panel
- Chime Wall
- Curved Overhead Ladder
- Grade Climber with Handrails
- Spelling Panel
- Tic-Tac-Toe
- Tot Slide Chute, Curved
- Welcome/Rules Sign

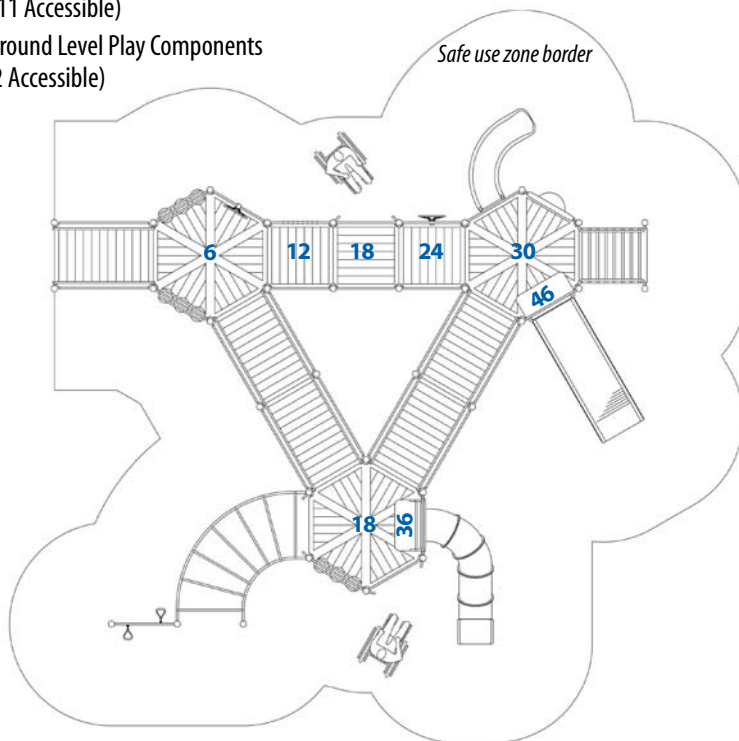

Plan-view scale: 3/32" = 1' (1 = 133mm)

Colors Illustrated:

- Posts:** Chrome Yellow
- Accessories:** Evergreen
- Decks:** Wood
- Plastic:** Yellow

Deck Heights:

- 6" 150mm
- 12" 305mm
- 18" 455mm
- 24" 610mm
- 30" 760mm
- 36" 915mm
- 46" 1170mm



WARNING

METAL PLAYING SURFACES CAN BECOME DANGEROUSLY HOT WHEN EXPOSED TO DIRECT SUNLIGHT. OWNERS/OPERATORS MUST WARN USERS THAT SERIOUS THERMAL BURNS MAY RESULT WHEN BARE SKIN COMES IN CONTACT WITH HOT METAL.

Play Area, Equipment Only:

17' x 18' (5.2m x 5.5m)

Minimum Safe Use Zone:

29' x 30' (8.9m x 9.2m)

Appropriate for Children 5 to 12 Years of Age.

Model No. 7807

Colors Illustrated:

Posts: InterPlay Chrome

Accessories: InterPlay Chrome & Black

Accessibility Profile:

- 5 Total Play Components
- 0 Elevated Play Components (0 Accessible)
- 5 Ground Level Play Components (5 Accessible)

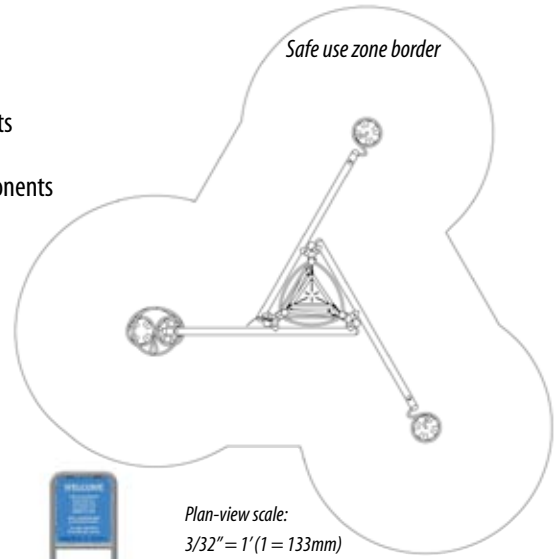

Plan-view scale:
3/32" = 1' (1 = 133mm)



InterPlay
ACTIVE KID MODULES™

Play Area, Equipment Only:

17' x 17' (5.2m x 5.2m)

Minimum Safe Use Zone:

29' x 29' (8.9m x 8.9m)

Appropriate for Children 5 to 12 Years of Age.

Model No. 7815

InterPlay
ACTIVE KID MODULES™

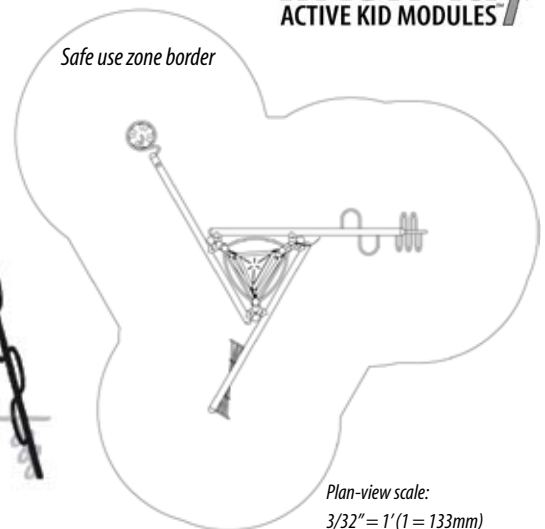

Plan-view scale:
3/32" = 1' (1 = 133mm)

Accessibility Profile:

- 5 Total Play Components
- 0 Elevated Play Components (0 Accessible)
- 5 Ground Level Play Components (5 Accessible)



Colors Illustrated:

Posts: InterPlay Chrome

Accessories: InterPlay Chrome & Black

Model No. 7823

Appropriate for Children 5 to 12 Years of Age.

Play Area, Equipment Only:

17' x 16' (5.2m x 4.9m)

Minimum Safe Use Zone:

29' x 28' (8.9m x 8.6m)

InterPlay
ACTIVE KID MODULES

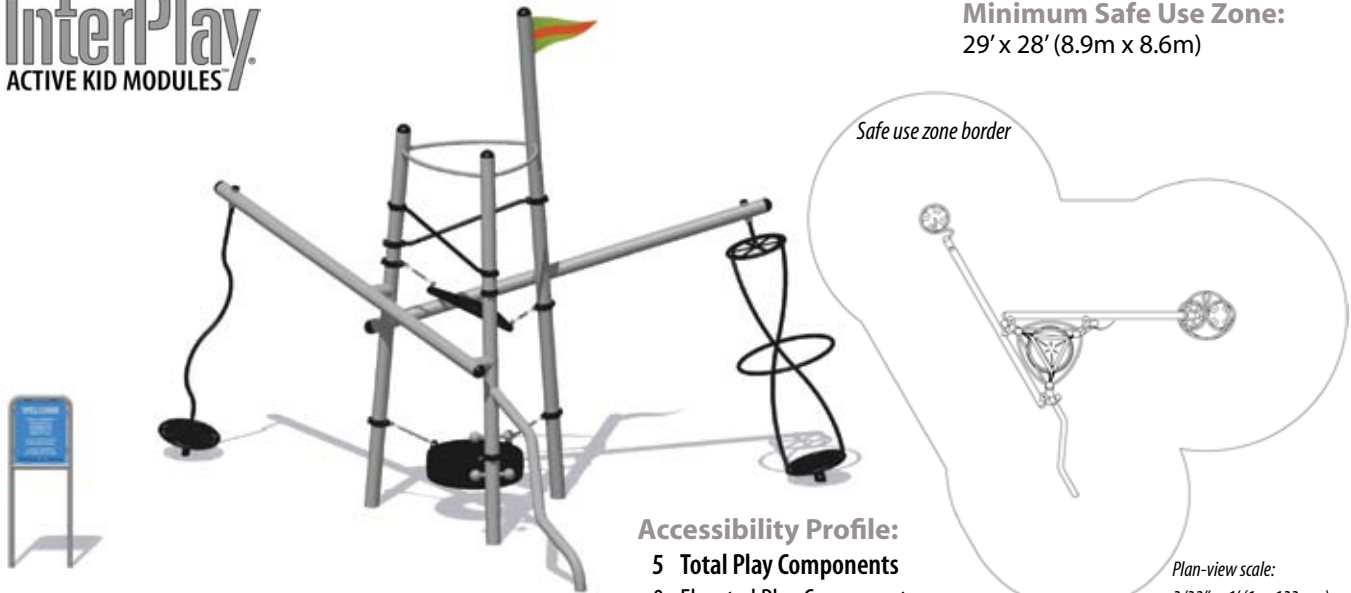

Colors Illustrated:

Posts: InterPlay Chrome

Accessories: InterPlay Chrome & Black

Accessibility Profile:

- 5 Total Play Components
- 0 Elevated Play Components (0 Accessible)
- 5 Ground Level Play Components (5 Accessible)

Plan-view scale:
3/32" = 1' (1 = 133mm)



Model No. 7831

Appropriate for Children 5 to 12 Years of Age.

Play Area, Equipment Only:

15' x 16' (4.6m x 4.9m)

Minimum Safe Use Zone:

27' x 28' (8.3m x 8.6m)

InterPlay
ACTIVE KID MODULES

Colors Illustrated:

Posts: InterPlay Chrome

Accessories: InterPlay Chrome & Black



Plan-view scale:
3/32" = 1' (1 = 133mm)



Accessibility Profile:

- 5 Total Play Components
- 0 Elevated Play Components (0 Accessible)
- 5 Ground Level Play Components (5 Accessible)



WARNING

METAL PLAYING SURFACES CAN BECOME DANGEROUSLY HOT WHEN EXPOSED TO DIRECT SUNLIGHT. OWNERS/OPERATORS MUST WARN USERS THAT SERIOUS THERMAL BURNS MAY RESULT WHEN BARE SKIN COMES IN CONTACT WITH HOT METAL.

Play Area, Equipment Only:

11' x 11' (3.4m x 3.4m)

Minimum Safe Use Zone:

23' x 23' (7.1m x 7.1m)

Colors Illustrated:

Posts: InterPlay Chrome

Accessories: InterPlay Chrome & Black

Accessibility Profile:

- 1 Total Play Components
- 0 Elevated Play Components (0 Accessible)
- 1 Ground Level Play Components (1 Accessible)

Appropriate for Children 5 to 12 Years of Age.

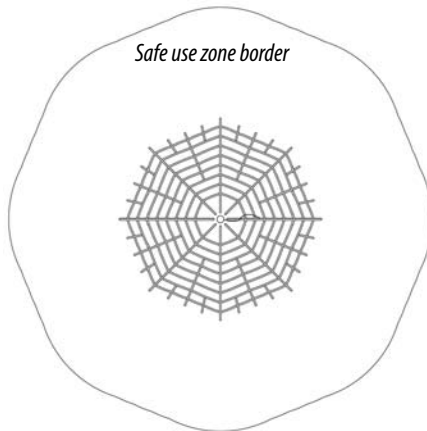

Plan-view scale: 3/32" = 1' (1 = 133mm)

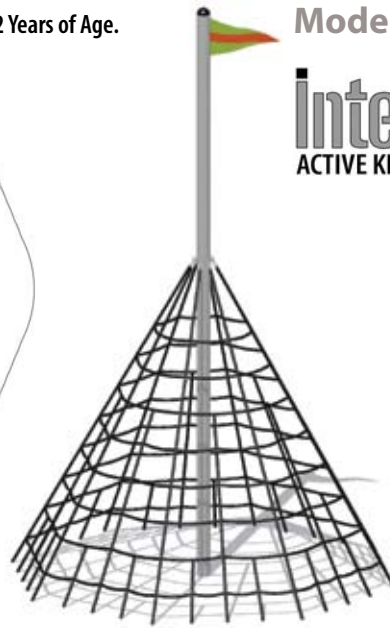

Model No. 7839

InterPlay
ACTIVE KID MODULES™



Play Area, Equipment Only:

17' x 16' (5.2m x 4.9m)

Minimum Safe Use Zone:

29' x 28' (8.9m x 8.6m)

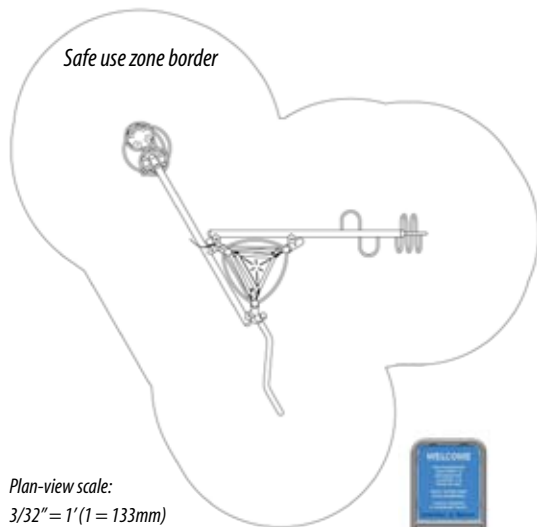

Plan-view scale: 3/32" = 1' (1 = 133mm)

Appropriate for Children 5 to 12 Years of Age.



Model No. 7847

InterPlay
ACTIVE KID MODULES™

Accessibility Profile:

- 5 Total Play Components
- 0 Elevated Play Components (0 Accessible)
- 5 Ground Level Play Components (5 Accessible)

Colors Illustrated:

Posts: InterPlay Chrome

Accessories: InterPlay Chrome & Black



Model No. 7855

Appropriate for Children 5 to 12 Years of Age.

Play Area, Equipment Only:

17' x 11' (5.2m x 3.4m)

Minimum Safe Use Zone:

29' x 23' (8.9m x 7.1m)

InterPlay
ACTIVE KID MODULES™

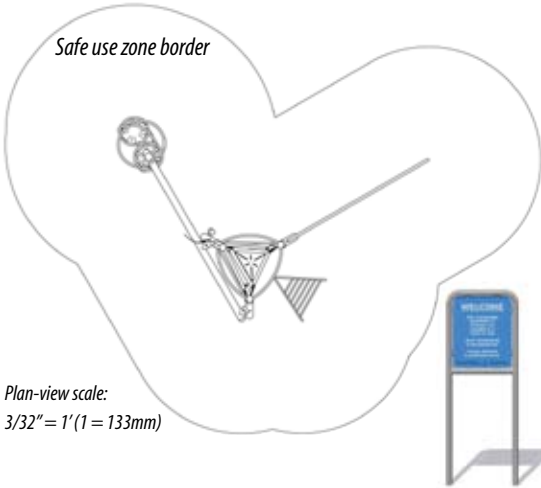

Accessibility Profile:

5 Total Play Components

0 Elevated Play Components
(0 Accessible)

5 Ground Level Play Components
(5 Accessible)



Colors Illustrated:

Posts: InterPlay Chrome

Accessories: InterPlay Chrome & Black

Model No. 7863

Appropriate for Children 5 to 12 Years of Age.

Play Area, Equipment Only:

17' x 11' (5.2m x 3.4m)

Minimum Safe Use Zone:

29' x 23' (8.9m x 7.1m)

InterPlay
ACTIVE KID MODULES™

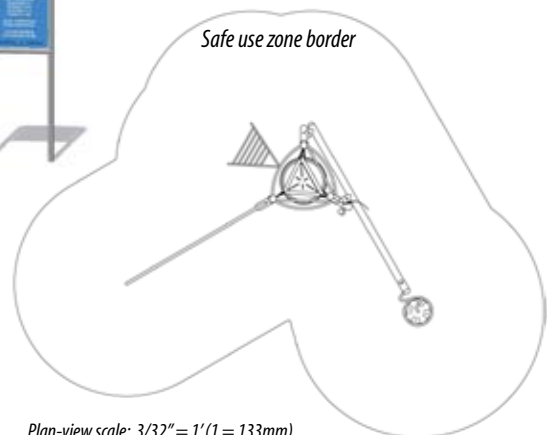

Accessibility Profile:

5 Total Play Components

0 Elevated Play Components
(0 Accessible)

5 Ground Level Play Components
(5 Accessible)



Colors Illustrated:

Posts: InterPlay Chrome

Accessories: InterPlay Chrome & Black

WARNING

METAL PLAYING SURFACES CAN BECOME DANGEROUSLY HOT WHEN EXPOSED TO DIRECT SUNLIGHT. OWNERS/OPERATORS MUST WARN USERS THAT SERIOUS THERMAL BURNS MAY RESULT WHEN BARE SKIN COMES IN CONTACT WITH HOT METAL.

Play Area, Equipment Only:
27' x 15' (8.3m x 4.6m)

Minimum Safe Use Zone:
39' x 27' (11.9m x 8.3m)

Appropriate for Children 5 to 12 Years of Age.

Colors Illustrated:

Posts: InterPlay Chrome

Accessories: InterPlay Chrome & Black

Model No. 7871

InterPlay®
ACTIVE KID MODULES™

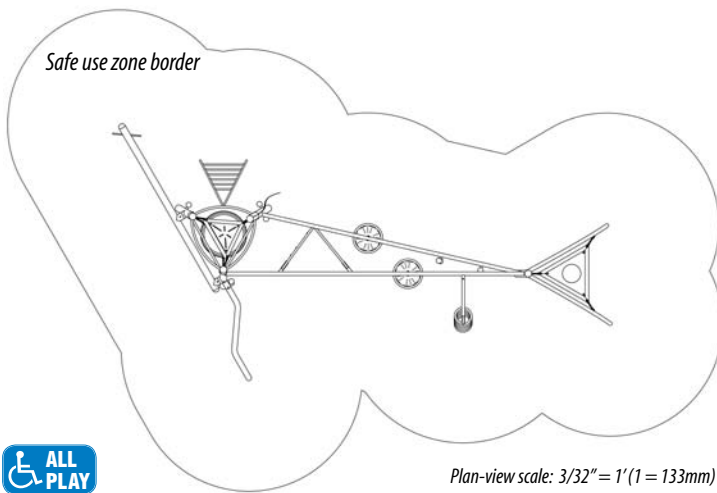

Accessibility Profile:

12 Total Play Components

0 Elevated Play Components
(0 Accessible)

12 Ground Level Play Components
(12 Accessible)



CASPAX-7™ Powder-Coating: All InterPlay “colored” metal is finished with CASPAX-7 lead-free powder coating. CASPAX-7 provides rich colors that are ultraviolet (UV) stabilized, durable and smooth— free from runs, drips or sags. The finishing process emits no volatile solvents to the atmosphere and is safe and ecologically sound.

CASPAX-7™ Standard Powder-Coating Colors

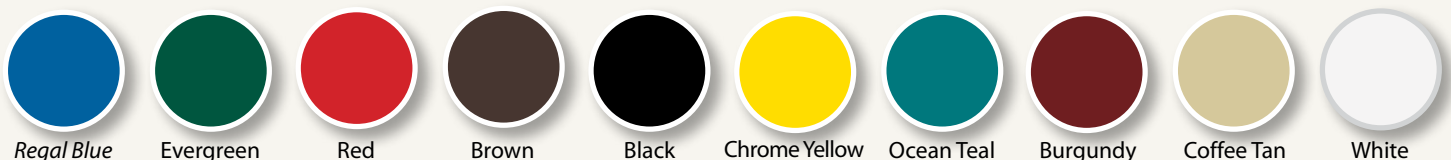

Due to variations in the printing process the colors shown above are only a guide to the actual powder-coating colors.

Model No. 7879

Appropriate for Children 5 to 12 Years of Age.

Play Area, Equipment Only:
29' x 16' (8.9m x 4.9m)

InterPlay
ACTIVE KID MODULES™

Colors Illustrated:

Posts: InterPlay Chrome

Accessories: InterPlay Chrome & Black

Minimum Safe Use Zone:
41' x 28' (12.5m x 8.6m)



Accessibility Profile:

- 12 Total Play Components
- 0 Elevated Play Components (0 Accessible)
- 12 Ground Level Play Components (12 Accessible)

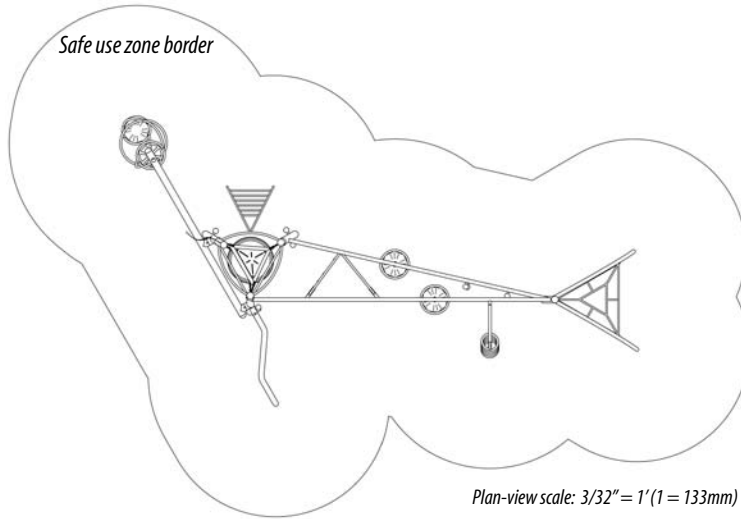

Raw galvanized pipe is NOT used on InterPlay "Active Kid Modules." In conformance with 2009 U.S. Consumer Products Safety Commission regulations banning lead in articles intended for use by children, only lead-free **CASPAX-7™** Powder-Coating is applied to our thick-wall (Schedule 40) steel pipe posts, connecting pipes and metal accessories. The CPSC ban specifically addresses children licking their fingers after they play or touch products that contain lead.

Twenty Examples of Over 200 Available CASPAX-7™ Designer Powder-Coating Colors



Due to variations in the printing process the colors shown above are only a guide to the actual powder-coating colors.



59-A



59-B



59-C



59-D



59-E



59-F



59-G



59-H



59-I



60-A



60-B



60-C



60-D



60-E



60-F



61-A



RePlay = 100% Post-Consumer HDPE Plastic Timbers



61-B



61-C



61-D



61-E



TimberForm-2 Model No. 4803-TF RePlay Model No. 4803-RP

Appropriate for Children 2 to 5 Years of Age.

Play Area, Equipment Only:
19' x 21' (5.8m x 6.5m)

Minimum Safe Use Zone:
31' x 33' (9.5m x 10.1m)

Accessibility Profile:

- 11 Total Play Components
- 7 Elevated Play Components
(7 Accessible)
- 4 Ground Level Play Components
(4 Accessible)

4803 Features:

- Accessible Entrance Deck
- Addition Panel
- Bubble Panel
- Kid's Bench
- Slide Chute, Curved
- Spelling Panel
- Stepping Pad (5)
- Storefront Countertop
- Talk Tube
- Tot Slide Chute, Curved
- Welcome/Rules Sign
- Wide Chute
- Wood Roof
- Wood Wall
- Wood Wall with Ship's Wheel



Colors Illustrated:

Accessories: Evergreen

Decks: SofDek Plastic-coated
Perforated Steel, Brown

Plastic: Yellow

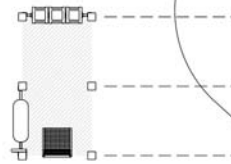

Play features
beneath decks

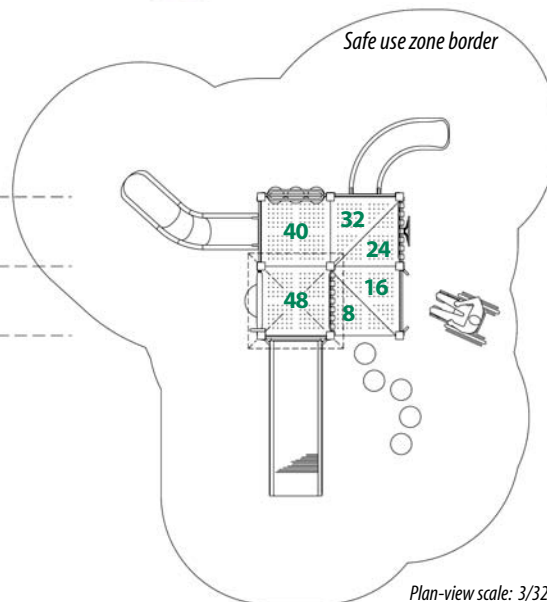

Deck Heights:

8"	205mm
16"	405mm
24"	610mm
32"	815mm
40"	1015mm
48"	1220mm

Plan-view scale: 3/32" = 1' (1 = 133mm)



TimberForm RePlay can help achieve LEED® Credits for Recycled Content.

LEED is a registered trademark of the U. S. Green Building Council.

WARNING

METAL PLAYING SURFACES CAN BECOME DANGEROUSLY HOT WHEN EXPOSED TO DIRECT SUNLIGHT. OWNERS/OPERATORS MUST WARN USERS THAT SERIOUS THERMAL BURNS MAY RESULT WHEN BARE SKIN COMES IN CONTACT WITH HOT METAL.

Play Area, Equipment Only: Appropriate for Children 2 to 5 Years of Age.
19' x 18' (5.8m x 5.5m)

Minimum Safe Use Zone:
31' x 30' (9.5m x 9.2m)

TimberForm-2 Model No. 4807-TF
Replay Model No. 4807-RP

Accessibility Profile:

- 8 Total Play Components
- 6 Elevated Play Components (6 Accessible)
- 2 Ground Level Play Components (2 Accessible)



Colors Illustrated:

- Accessories:** Brown
- Decks:** SofDek Plastic-coated Perforated Steel, Brown
- Plastic:** Yellow

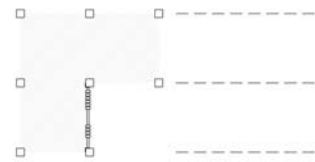

Play features beneath decks

Deck Heights:

- 8" 205mm
- 16" 405mm
- 24" 610mm
- 32" 815mm
- 40" 1015mm
- 48" 1220mm

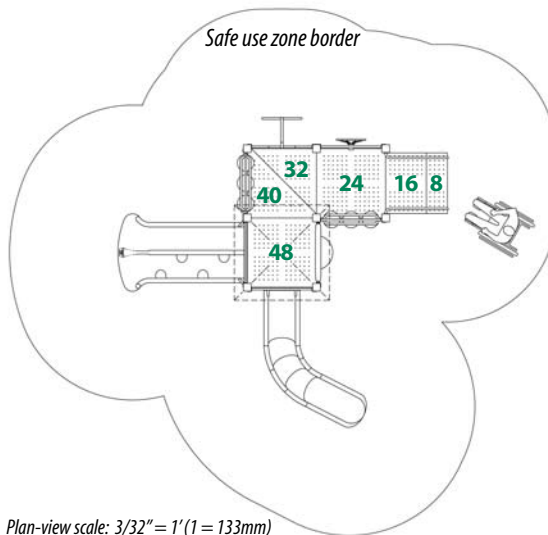

4807 Features:

- Abacus
- Accessible Transfer Station, 8" (21cm) Riser
- Baluster Wall with Ship's Wheel
- Bubble Panel
- Roof
- Slide Chute, Curved
- Spelling Panel, Baluster Wall
- Tic-Tac-Toe
- Vertical Loop Climber
- Welcome/Rules Sign
- Wide Slide Chute, Wave/Slalom



TimberForm RePlay Plastic Members are made from 100% recycled post-consumer plastic products. Recycled plastic is the environmentally friendly choice when selecting new playground equipment. TimberForm RePlay posts and beams are extruded (not molded) from recycled high density polyethylene (H.D.P.E.). The result is a dense, strong member with uniform surface texture and color throughout so maintenance issues are minimal.



TimberForm-2 Model No. 4812-TF RePlay Model No. 4812-RP

Appropriate for Children 2 to 5 Years of Age.

Play Area, Equipment Only:

14' x 21' (4.3m x 6.5m)

Minimum Safe Use Zone:

26' x 33' (8.0m x 10.1m)

Accessibility Profile:

- 8 Total Play Components
- 6 Elevated Play Components
(6 Accessible)
- 2 Ground Level Play Components
(2 Accessible)



Colors Illustrated:

Accessories: Red

Decks: SofDek Plastic-coated
Perforated Steel, Brown

Plastic: Yellow



4812 Features:

- Accessible Transfer Station,
8" (21cm) Riser
- Baluster Wall with Ship's Wheel
- Bubble Panel
- Climbing Ramp
- Coil Climber
- School Bus Panel
- School Bus with Wheel
and Wood Seats
- Spelling Panel, Baluster Wall
- Welcome/Rules Sign
- Wide Chute
- Wood Roof

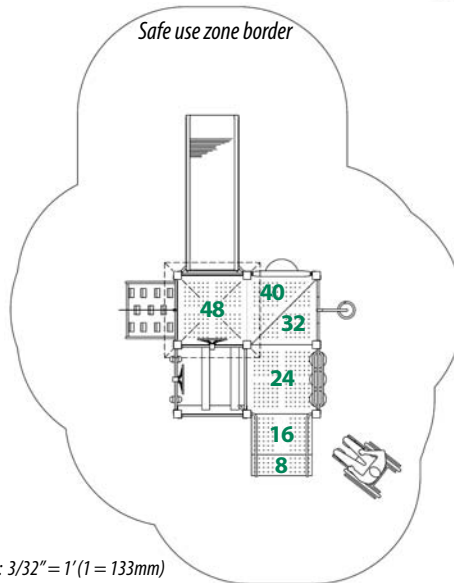

Deck Heights:

- 8" 205mm
- 16" 405mm
- 24" 610mm
- 32" 815mm
- 40" 1015mm
- 48" 1220mm

Plan-view scale: 3/32" = 1' (1 = 133mm)



TimberForm Free-of-heart-center Timbers are playground equipment grade Douglas fir that is free-of-heart-center (F.O.H.C.). The F.O.H.C. specification is critically important. Timber containing the tree's heart or pith will perform poorly in time and have a short useful life.



WARNING

METAL PLAYING SURFACES CAN BECOME DANGEROUSLY HOT WHEN EXPOSED TO DIRECT SUNLIGHT. OWNERS/OPERATORS MUST WARN USERS THAT SERIOUS THERMAL BURNS MAY RESULT WHEN BARE SKIN COMES IN CONTACT WITH HOT METAL.

Play Area, Equipment Only: Appropriate for Children 5 to 12 Years of Age.
24' x 18' (7.4m x 5.5m)

Minimum Safe Use Zone:
36' x 30' (11.0m x 9.2m)

TimberForm-2 Model No. 4816-TF
Recycle Replay Model No. 4816-RP

Accessibility Profile:

- 9 Total Play Components
- 7 Elevated Play Components (7 Accessible)
- 2 Ground Level Play Components (2 Accessible)



4816 Features:

- Accessible Transfer Station, 8" (21cm) Riser
- Addition Panel
- Baluster Wall (2)
- Baluster Wall with Ship's Wheel
- Bubble Panel
- Loop Climber with Handrails
- Spelling Panel
- Spiral Slide Chute
- Storefront Countertop
- Talk Tube
- Welcome/Rules Sign
- Wide Chute
- Wood Roof

Colors Illustrated:

- Accessories:** Evergreen
- Decks:** SofDek Plastic-coated Perforated Steel, Brown
- Plastic:** Tan

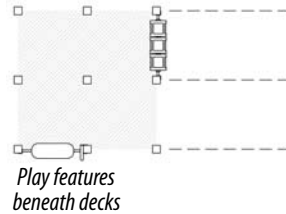

Deck Heights:

- 8" 205mm
- 16" 405mm
- 24" 610mm
- 32" 815mm
- 40" 1015mm
- 48" 1220mm
- 56" 1420mm

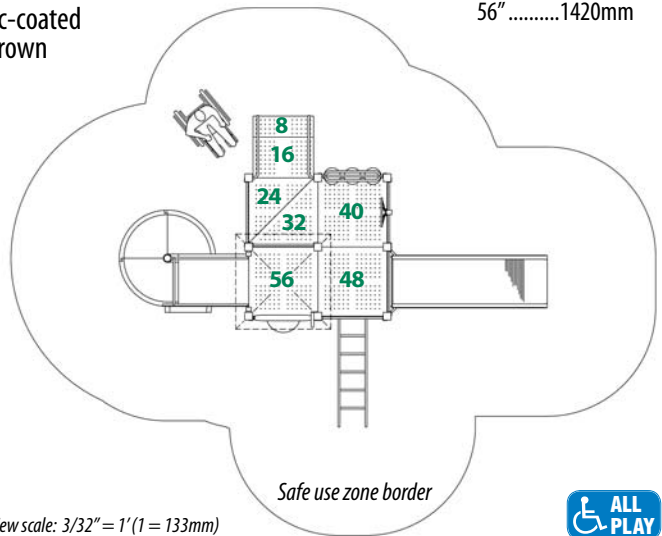

Plan-view scale: 3/32" = 1' (1 = 133mm)



Arsenic-Free Wood Preservative

All wood components used on TimberForm-2 Play Areas and Accessories are pressure-preservatively treated after all fabrication is completed with a child-friendly wood preservative.

Columbia Cascade does not and has never used arsenic-based wood preservatives.



TimberForm-2 Model No. 4820-TF RePlay Model No. 4820-RP

Appropriate for Children 5 to 12 Years of Age.

Play Area, Equipment Only:
24' x 17' (7.4m x 5.2m)

Minimum Safe Use Zone:
36' x 29' (11.0m x 8.9m)

Accessibility Profile:

- 11 Total Play Components
- 8 Elevated Play Components
(4 Accessible)
- 3 Ground Level Play Components
(3 Accessible)

Colors Illustrated:

Accessories: Regal Blue

Decks: SofDek Plastic-coated
Perforated Steel, Brown

Plastic: Yellow



4820 Features:

- Accessible Transfer Station, 6" (15cm) Riser
- Addition Panel
- Arch Ring Climber
- Bubble Panel
- Decorative Wall (3)
- Decorative Wall with Two Ship's Wheels
- Kid's Bench
- Spelling Panel
- Spiral Slide Chute
- Talk Tube
- Tot Slide Chute, Curved
- Vertical Loop Climber
- Welcome/Rules Sign
- Wood Roof

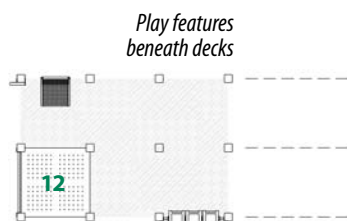

Deck Heights:

6"	150mm
12"	305mm
18"	455mm
24"	610mm
30"	760mm
36"	915mm
48"	1220mm
60"	1525mm

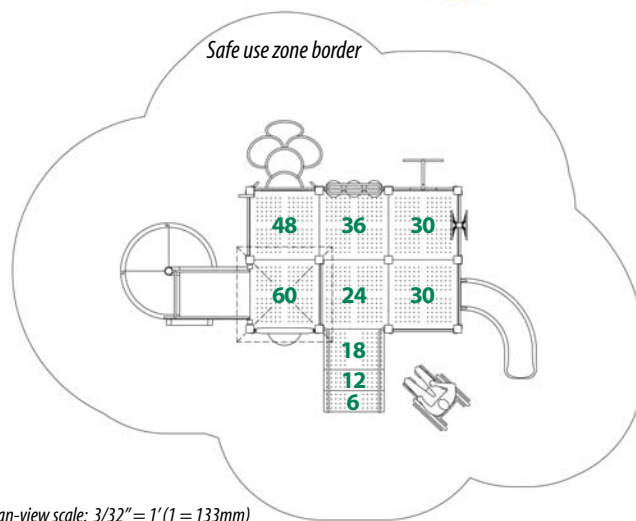

Rotationally-molded Plastic Accessories TimberForm, RePlay and PipeLine plastic accessories are manufactured from hot-compounded medium density polyethylene (MDPE). Hot-compounding assures uniform coloration within each part and from part to part and maximum UV resistance. The final wall-thickness of our rotationally-molded plastic accessories (shown in yellow at left) is 50% thicker (both shown actual thickness) than the industry standard adding to strength, durability and long useful life. Our plastics are free of PVC and phthalates.



WARNING

METAL PLAYING SURFACES CAN BECOME DANGEROUSLY HOT WHEN EXPOSED TO DIRECT SUNLIGHT. OWNERS/OPERATORS MUST WARN USERS THAT SERIOUS THERMAL BURNS MAY RESULT WHEN BARE SKIN COMES IN CONTACT WITH HOT METAL.

Play Area, Equipment Only: Appropriate for Children 5 to 12 Years of Age.
33' x 19' (10.1m x 5.8m)

Minimum Safe Use Zone:
45' x 31' (13.8m x 9.5m)

TimberForm-2 Model No. 4825-TF
Replay Model No. 4825-RP

Accessibility Profile:

12 Total Play Components

9 Elevated Play Components
(6 Accessible)

3 Ground Level Play Components
(3 Accessible)



Play Area, Spring Rider Only:
3' x 2' (1.0m x 0.7m)

Minimum Safe Use Zone:
15' x 14' (4.6m x 4.3m)

4825 Features:

- Accessible Spring Rider
- Accessible Transfer Station, 6" (15cm) Riser
- Baluster Wall with Ship's Wheel (2)
- Bubble Panel
- Cargo Net
- Maze Panel
- Ring Beam, Double, 12' (366cm)
- Spelling Panel, Baluster Wall
- Tube Chute, Curved
- Vertical Loop Climber
- Vertical Safety Climber
- Welcome/Rules Sign
- Wide Chute

Colors Illustrated:

Accessories: Evergreen

Decks: SofDek Plastic-coated
Perforated Steel, Brown

Plastic: Tan

Deck Heights:

- 6" 150mm
- 12" 305mm
- 18" 455mm
- 24" 610mm
- 30" 760mm
- 36" 915mm
- 48" 1220mm

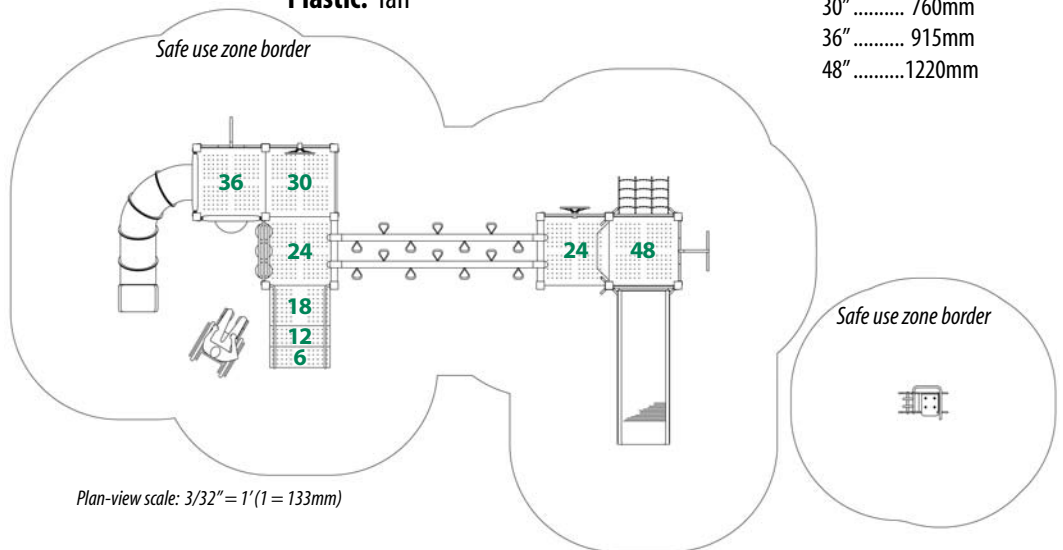



TimberForm-2 Model No. 4829-TF Appropriate for Children 5 to 12 Years of Age. **RePlay Model No. 4829-RP**

Play Area, Equipment Only:
35' x 13' (10.7m x 4.0m)

Minimum Safe Use Zone:
47' x 25' (14.4m x 7.7m)

Accessibility Profile:

- 18 Total Play Components**
- 13 Elevated Play Components (13 Accessible)
- 5 Ground Level Play Components (5 Accessible)

Colors Illustrated:

- Accessories:** Evergreen
- Decks:** SofDek Plastic-coated Perforated Steel, Brown
- Plastic:** Tan

Deck Heights:

- 8" 205mm
- 16" 405mm
- 24" 610mm
- 32" 815mm
- 40" 1015mm
- 48" 1220mm
- 56" 1420mm
- 64" 1625mm
- 72" 1830mm



4829 Features:

- Accessible Entrance Deck
- Block Climber
- Bubble Panel
- Chime Wall
- Chinning Bar (2)
- Firefighter's Pole
- Gable Trellis Roof
- Kid's Bench
- Overhead Safety Ladder
- Panel with Hole
- Spiral Slide Chute
- Storefront Countertop
- Talk Tube (2)
- Vertical Ladder
- Vertical Loop Climber

- Welcome/Rules Sign
- Window Panel
- Wood Wall
- Wood Wall with Ship's Wheel

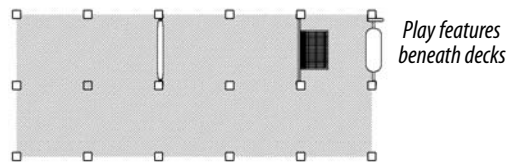
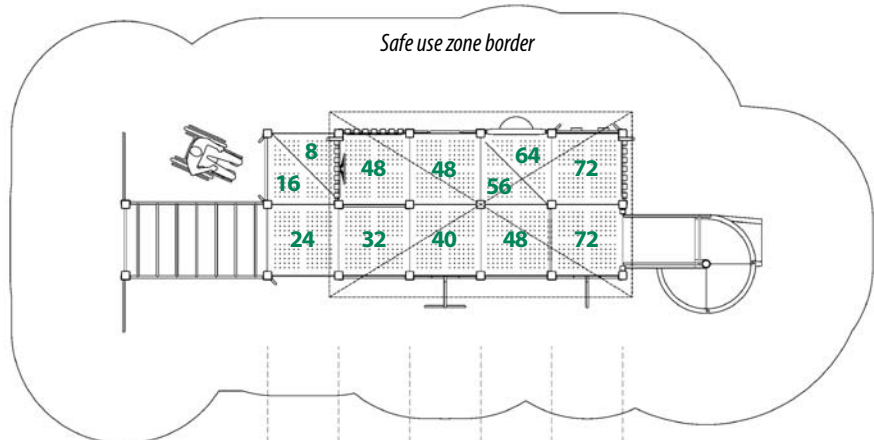

Plan-view scale: 3/32" = 1' (1 = 133mm)



WARNING

METAL PLAYING SURFACES CAN BECOME DANGEROUSLY HOT WHEN EXPOSED TO DIRECT SUNLIGHT. OWNERS/OPERATORS MUST WARN USERS THAT SERIOUS THERMAL BURNS MAY RESULT WHEN BARE SKIN COMES IN CONTACT WITH HOT METAL.

Play Area, Equipment Only: Appropriate for Children 5 to 12 Years of Age. **TimberForm-2 Model No. 4833-TF**
Replay Model No. 4833-RP

Minimum Safe Use Zone:
 34' x 38' (10.4m x 11.6m)



4833 Features:

- Accessible Transfer Station, 8" (21 cm) Riser
- Baluster Wall with Ship's Wheel (2)
- Bubble Panel
- Coil Climber
- Convex/Flat Mirror Panel
- Curved Overhead Ladder
- Kid's Bench
- Loop Climber with Handrails
- Spelling Panel
- Spiral Slide Chute
- Storefront Countertop
- Tot Slide Chute, Curved
- Vertical Ladder
- Welcome/Rules Sign

Accessibility Profile:

- 13 Total Play Components**
- 8 Elevated Play Components (4 Accessible)
- 5 Ground Level Play Components (5 Accessible)

Colors Illustrated:

- Accessories:** Red
- Decks:** SofDek Plastic-coated Perforated Steel, Brown
- Plastic:** Yellow

Deck Heights:

- 8" 205mm
- 16" 405mm
- 24" 610mm
- 32" 815mm
- 48" 1220mm
- 72" 1830mm

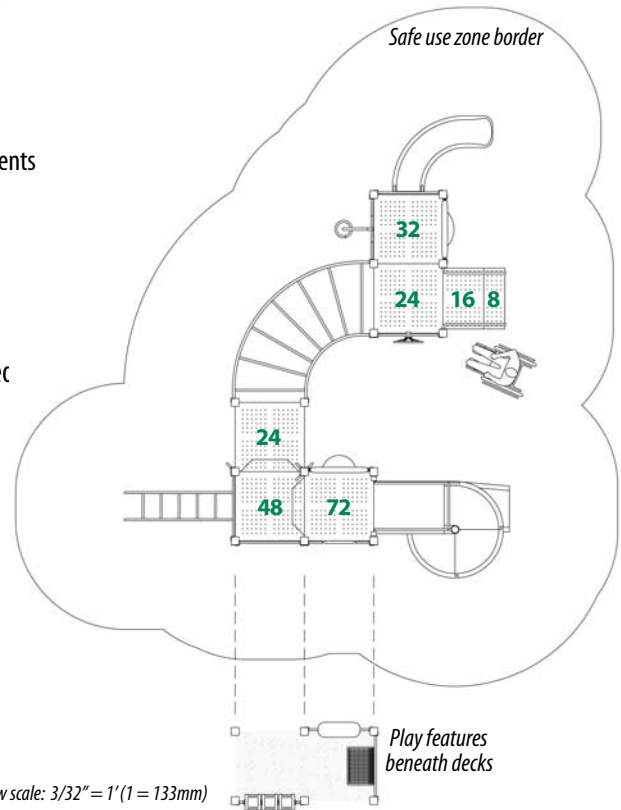

Community-Built TimberForm-2 & RePlay Playgrounds

Community leaders are changing the face of playgrounds everywhere and Columbia Cascade makes it easier than ever. Neighbors using home power-tools and levels can assemble most TimberForm-2 and RePlay structures in less than a day. The need for many concreted posts is dramatically reduced allowing for much simpler and quicker installation by volunteers.



TimberForm-2 Model No. 4838-TF Appropriate for Children 5 to 12 Years of Age. RePlay Model No. 4838-RP

Play Area, Equipment Only:
 28' x 25' (8.6m x 7.7m)

Minimum Safe Use Zone:
 40' x 37' (12.2m x 11.3m)

Accessibility Profile:

- 14 Total Play Components**
- 10 Elevated Play Components
 (10 Accessible)
- 4 Ground Level Play Components
 (4 Accessible)



Colors Illustrated:

Accessories: Evergreen

Decks: SofDek Plastic-coated
 Perforated Steel, Brown

Plastic: Tan

4838 Features:

- Accessible Transfer Station, 8" (21 cm) Riser
- Arch Ring Climber
- Cargo Net
- Chime Wall
- Firefighter's Pole
- Kid's Table with GameBoard
- Loop Climber
- Overhead Ladder
- Perforated Steel Roof (2)
- Slide Chute
- Spelling Panel
- Spiral Slide Chute
- Storefront Countertop
- Talk Tube
- Tunnel Crawl
- Welcome/Rules Sign
- Wood Wall (3)
- Wood Wall with Ship's Wheel

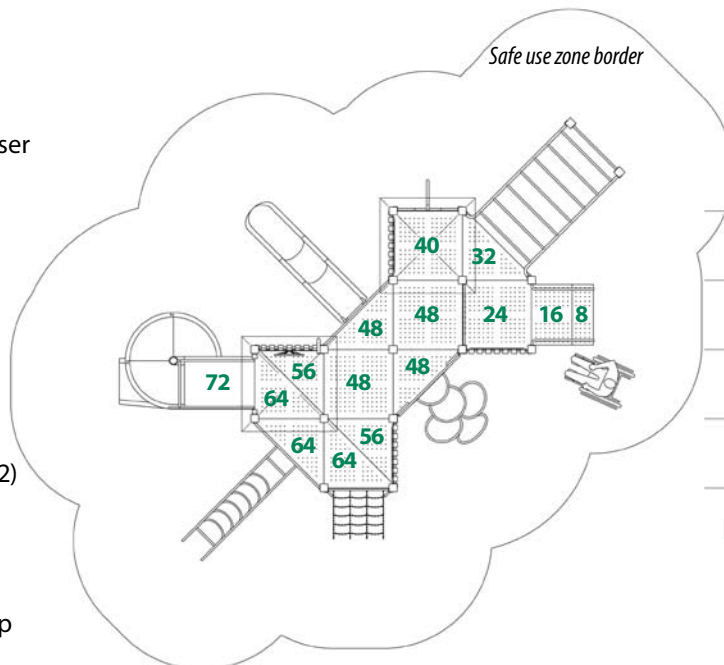

Plan-view scale: 3/32" = 1' (1 = 133mm)

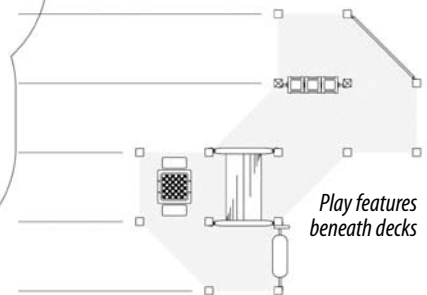

Deck Heights:

- 8" 205mm
- 16" 405mm
- 24" 610mm
- 32" 815mm
- 40" 1015mm
- 48" 1220mm
- 56" 1420mm
- 64" 1625mm
- 72" 1830mm



WARNING

METAL PLAYING SURFACES CAN BECOME DANGEROUSLY HOT WHEN EXPOSED TO DIRECT SUNLIGHT. OWNERS/OPERATORS MUST WARN USERS THAT SERIOUS THERMAL BURNS MAY RESULT WHEN BARE SKIN COMES IN CONTACT WITH HOT METAL.

Play Area, Equipment Only: Appropriate for Children 5 to 12 Years of Age.
32' x 23' (9.8m x 7.1m)

TimberForm-2 Model No. 4842-TF
Recycle Model No. 4842-RP

Minimum Safe Use Zone:
44' x 35' (13.5m x 10.7m)



Colors Illustrated:

Accessories: Evergreen

Decks: SofDek Plastic-coated
Perforated Steel, Brown

Plastic: Tan

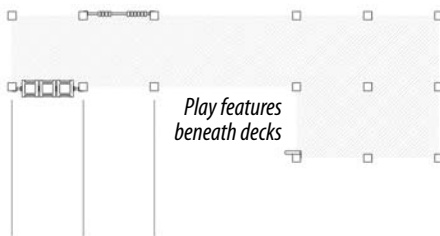

Accessibility Profile:

- 13 Total Play Components
- 9 Elevated Play Components (5 Accessible)
- 4 Ground Level Play Components (4 Accessible)

4842 Features:

- Abacus
- Accessible Transfer Station, 8" (21cm) Riser
- Arch Ring Climber
- Baluster Wall (2)
- Baluster Wall with Ship's Wheel (2)
- Bubble Panel
- Convex/Flat Mirror Panel
- Spelling Panel
- Spiral Slide Chute
- Suspension Bridge, Perforated Steel, with Baluster Walls
- Talk Tube
- Wave Chute
- Welcome/Rules Sign
- Wide Slide Chute, Wave/Slalom

Deck Heights:

- 8" 205mm
- 16" 405mm
- 24" 610mm
- 32" 815mm
- 40" 1015mm
- 48" 1220mm
- 60" 1525mm
- 72" 1830mm

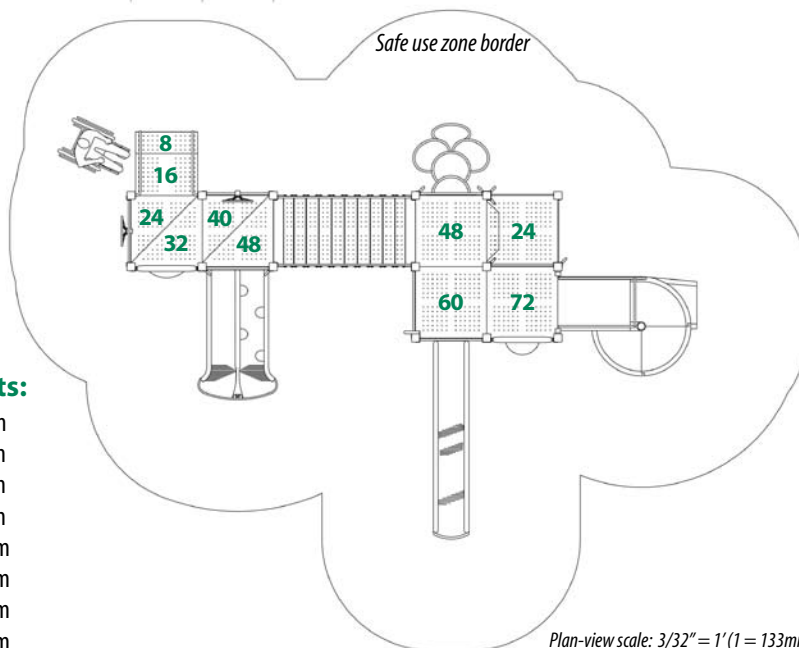



TimberForm-2 Model No. 4846-TF RePlay Model No. 4846-RP

Appropriate for Children 5 to 12 Years of Age.

Play Area, Equipment Only:
35' x 14' (10.7m x 4.3m)

Minimum Safe Use Zone:
47' x 26' (14.4m x 8.1m)

Accessibility Profile:

- 11 Total Play Components
- 8 Elevated Play Components
(4 Accessible)
- 3 Ground Level Play Components
(3 Accessible)

Colors Illustrated:

Accessories: Red

Decks: SofDek Plastic-coated
Perforated Steel, Brown

Plastic: Tan



4846 Features:

- Accessible Transfer Station, 6" (15cm) Riser
- Addition Panel
- Alphabet Panel
- Arched Bridge, Plastic-coated, Perforated Steel with Baluster Walls
- Baluster Wall (2)
- Baluster Wall with Ship's Wheel
- Bubble Panel
- Climbing Ramp
- Kid's Bench on Baluster Wall
- Lookout Platform, Baluster Wall
- School Bus with Wheel and Wood Seats
- Spelling Panel, Baluster Wall
- Spiral Slide Chute
- Talk Tube
- Tot Slide Chute, Curved
- Welcome/Rules Sign

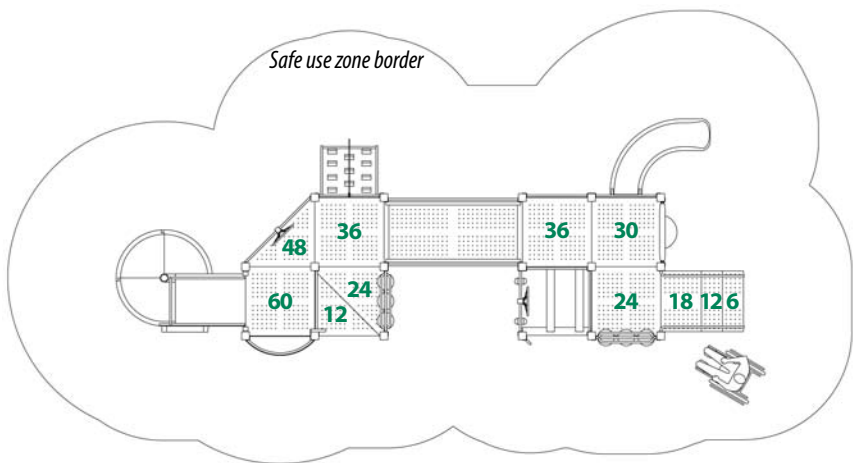

Plan-view scale: 3/32" = 1' (1 = 133mm)



Play features
beneath decks



Deck Heights:

6"	150mm	30"	760mm
12"	305mm	36"	915mm
18"	455mm	48"	1220mm
24"	610mm	60"	1525mm

WARNING

METAL PLAYING SURFACES CAN BECOME DANGEROUSLY HOT WHEN EXPOSED TO DIRECT SUNLIGHT. OWNERS/OPERATORS MUST WARN USERS THAT SERIOUS THERMAL BURNS MAY RESULT WHEN BARE SKIN COMES IN CONTACT WITH HOT METAL.

Play Area, Equipment Only: Appropriate for Children 2 to 5 Years of Age.
30' x 24' (9.2m x 7.4m)

Minimum Safe Use Zone:
42' x 36' (12.9m x 11.0m)

TimberForm-2 Model No. 4851-TF
Replay Model No. 4851-RP

Accessibility Profile:

- 11 Total Play Components
- 8 Elevated Play Components (5 Accessible)
- 3 Ground Level Play Components (3 Accessible)



4851 Features:

- Accessible Transfer Station, 8" (21cm) Riser
- Addition Panel
- Baluster Wall (3)
- Baluster Wall with Ship's Wheel
- Chime Wall
- Climbing Ramp
- Spelling Panel, Baluster Wall
- Spring Rider
- Tube Chute, "S" Curved
- Tunnel Crawl
- Vertical Loop Climber
- Vertical Safety Climber
- Welcome/Rules Sign
- Wide Chute
- Wood Roof (2)

Play features beneath decks



Play Area, Spring Rider Only:
3' x 2' (1.0m x 0.7m)

Minimum Safe Use Zone:
15' x 14' (4.6m x 4.3m)

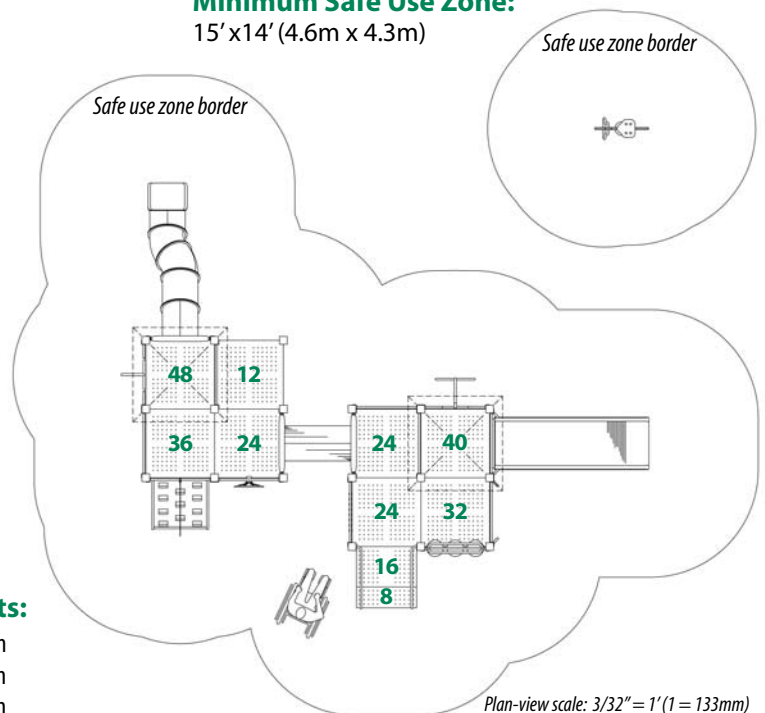

Plan-view scale: 3/32" = 1' (1 = 133mm)

Deck Heights:

- 8" 205mm
- 12" 305mm
- 16" 405mm
- 24" 610mm
- 32" 815mm
- 36" 915mm
- 40" 1015mm
- 48" 1220mm

Colors Illustrated:

- Accessories:** Regal Blue
- Decks:** SofDek Plastic-coated Perforated Steel, Brown
- Plastic:** Tan





TimberForm-2 Model No. 4855-TF RePlay Model No. 4855-RP

Appropriate for Children 5 to 12 Years of Age.

Play Area, Equipment Only:

46' x 21' (14.1m x 6.5m)

Minimum Safe Use Zone:

58' x 33' (17.7m x 10.1m)



Accessibility Profile:

15 Total Play Components

11 Elevated Play Components
(7 Accessible)

4 Ground Level Play Components
(4 Accessible)

4855 Features:

- Abacus
- Accessible Transfer Station, 8" (21cm) Riser
- Baluster Wall (10)
- Baluster Wall with Ship's Wheel
- Chime Wall
- Climbing Ramp
- Coil Climber
- Kid's Bench (2)
- Loop Climber
- School Bus with Wheel and Wood Seats
- Single Shed Trellis Roof, Wood (2)
- Spiral Slide Chute
- Storefront Countertop
- Super Ring Beam, 8' (244cm)
- Suspension Bridge, Steel, with Baluster Walls
- Talk Tube
- Welcome/Rules Sign
- Wide Chute

Colors Illustrated:

Accessories: Evergreen

Decks: SofDek Plastic-coated
Perforated Steel, Brown

Plastic: Yellow

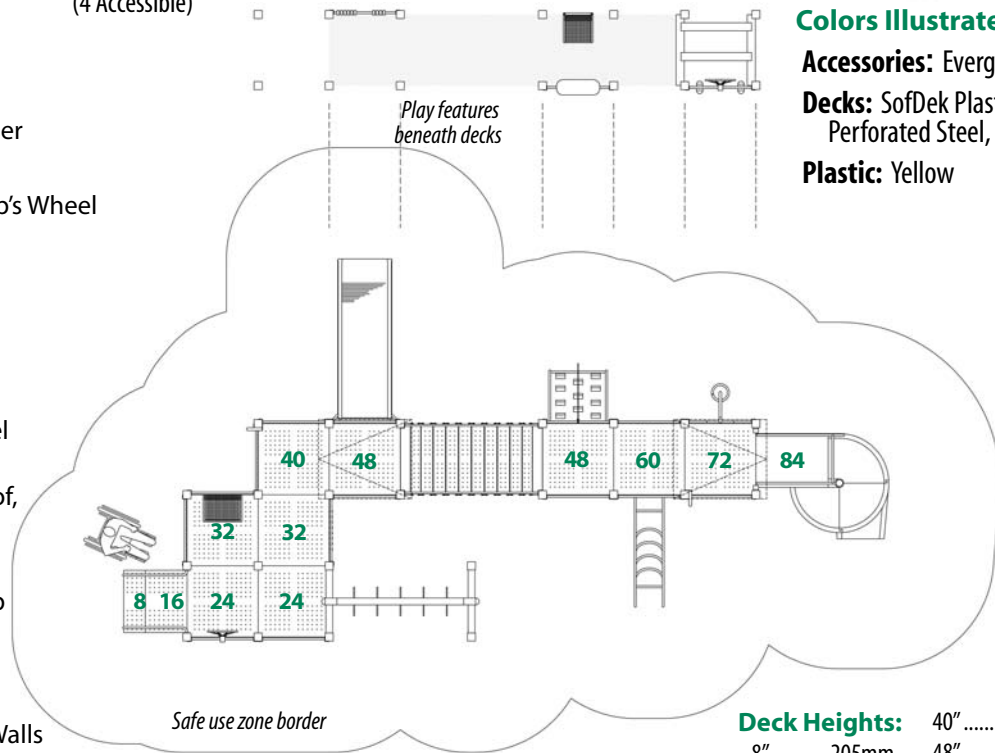

Deck Heights:	
40"	1015mm
8"	205mm
48"	1220mm
16"	405mm
60"	1525mm
24"	610mm
72"	1830mm
32"	815mm
84"	2135mm



WARNING

METAL PLAYING SURFACES CAN BECOME DANGEROUSLY HOT WHEN EXPOSED TO DIRECT SUNLIGHT. OWNERS/OPERATORS MUST WARN USERS THAT SERIOUS THERMAL BURNS MAY RESULT WHEN BARE SKIN COMES IN CONTACT WITH HOT METAL.

TimberForm®

Play Area, Equipment Only: Appropriate for Children 5 to 12 Years of Age.
31' x 31' (9.5m x 9.5m)

TimberForm-2 Model No. 4859-TF
Replay Model No. 4859-RP

Minimum Safe Use Zone:
43' x 43' (13.2m x 13.2m)



Accessibility Profile:

- 13 Total Play Components
- 10 Elevated Play Components (10 Accessible)
- 3 Ground Level Play Components (3 Accessible)

4859 Features:

- Accessible Transfer Station, 8" (21cm) Riser
- Chime Wall
- Chinning Bar
- Clatter Bridge, Wood with Baluster Walls
- Climbing Ramp
- Curved Cargo Net Climber (3)
- Lookout Platform with Ship's Wheel
- Panel with Hole
- Quad Wood Roof
- Slide Chute, Curved
- Stairs with Handrails
- Storefront Countertop
- Twisting Climber
- Vertical Ladder
- Vertical Loop Climber
- Welcome/Rules Sign
- Wheel Beam, 12' (366cm)

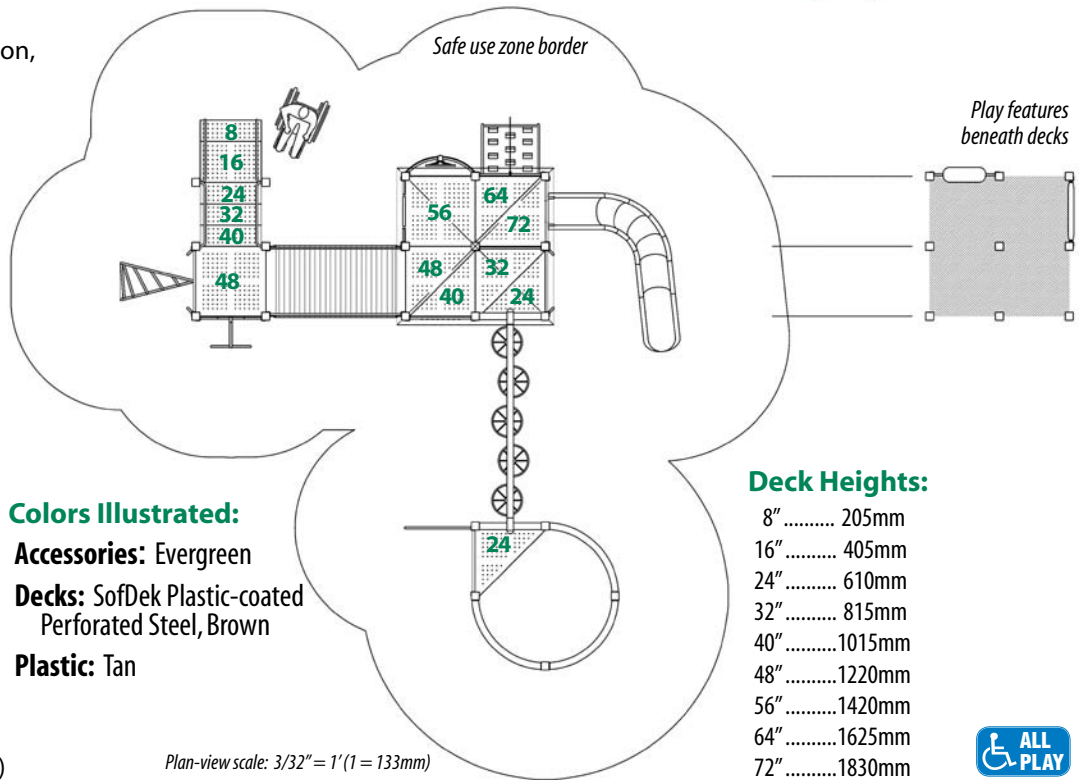

Colors Illustrated:

Accessories: Evergreen

Decks: SofDek Plastic-coated Perforated Steel, Brown

Plastic: Tan



Design Note: Keep in mind that TimberForm and RePlay play systems are modular in design and that most accessories are interchangeable. We encourage choosing features from several Play Areas and melding them into a unique design. Designs for phased installation are also possible. Contact us for more information.



TimberForm-2 Model No. 4864-TF RePlay Model No. 4864-RP

Appropriate for Children 5 to 12 Years of Age.

Play Area, Equipment Only:
25' x 24' (7.7m x 7.4m)

Minimum Safe Use Zone:
37' x 36' (11.3m x 11.0m)

Kid Spinner, Equipment Only:
5' x 4' (1.6m x 1.3m)

Minimum Safe Use Zone:
17' x 16' (5.2m x 4.9m)

Accessibility Profile:

- 9 Total Play Components
- 7 Elevated Play Components (7 Accessible)
- 2 Ground Level Play Components (2 Accessible)



Deck Heights:

- 8" 205mm
- 16" 405mm
- 24" 610mm
- 32" 815mm
- 40" 1015mm
- 48" 1220mm

4864 Features:

- Accessible Transfer Station, 8" (21cm) Riser
- Baluster Wall (7)
- Chime Wall
- Climbing Ramp
- Coil Climber
- Firefighter's Pole
- Overhead Ladder
- Slide Chute
- Spiral Spinner
- Suspension Bridge, Steel, with Baluster Walls
- Welcome/Rules Sign
- Wide Chute with Center Rail, Stainless Steel with 6" (15cm) Rails

Colors Illustrated:

- Accessories:** Evergreen
- Decks:** SofDek Plastic-coated Perforated Steel, Brown
- Plastic:** Tan

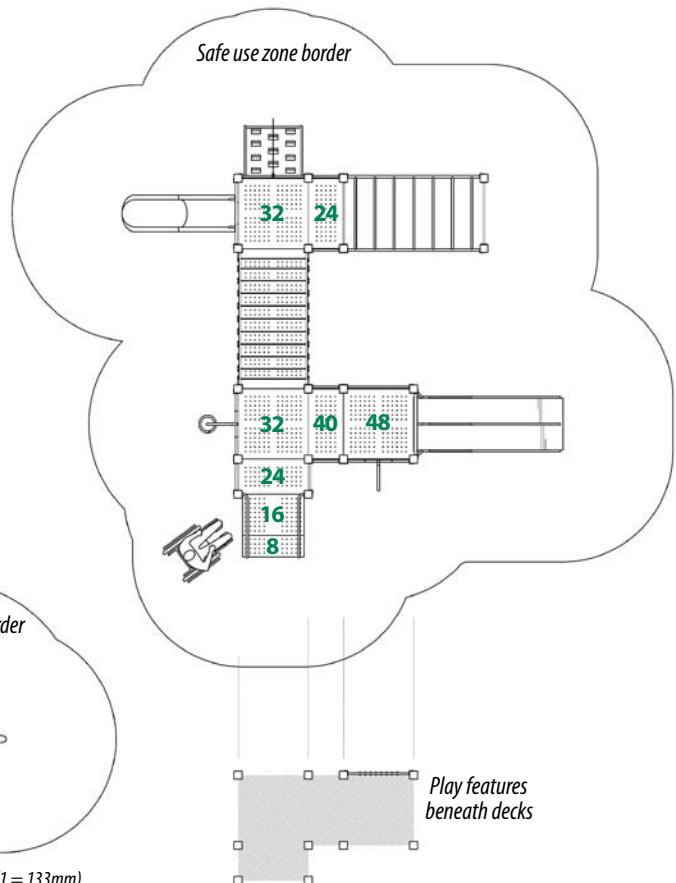

Plan-view scale: 3/32" = 1' (1 = 133mm)



Play Area, Equipment Only: Appropriate for Children 5 to 12 Years of Age.
32' x 23' (9.8m x 7.1m)

TimberForm-2 Model No. 4868-TF
Replay Model No. 4868-RP

Minimum Safe Use Zone:
44' x 35' (13.5m x 10.7m)

Accessibility Profile:

- 14 Total Play Components
- 10 Elevated Play Components (5 Accessible)
- 4 Ground Level Play Components (4 Accessible)

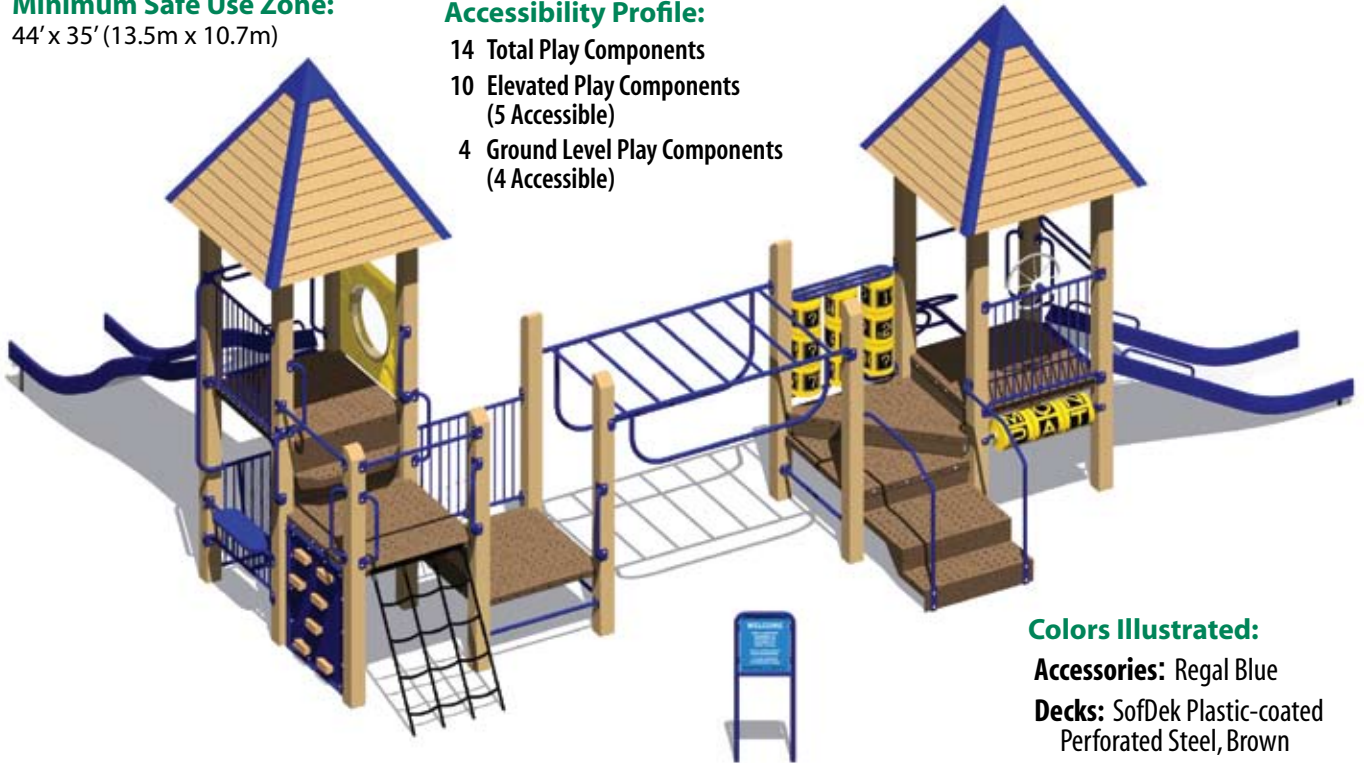

Colors Illustrated:

- Accessories:** Regal Blue
- Decks:** SofDek Plastic-coated Perforated Steel, Brown
- Plastic:** Yellow

4868 Features:

- Accessible Transfer Station, 8" (21cm) Riser
- Addition Panel
- Arch Loop Climber
- Baluster Wall
- Baluster Wall with Ship's Wheel (2)
- Block Climber
- Bubble Panel
- Cargo Net
- Kid's Bench
- Overhead Safety Ladder
- Spelling Panel
- Storefront Countertop
- Talk Tube
- Welcome/Rules Sign
- Wide Chute, Stainless Steel with 6" (15cm) Rails
- Wide Wave Chute, Stainless Steel with 6" (15cm) Rails
- Wood Roof (2)

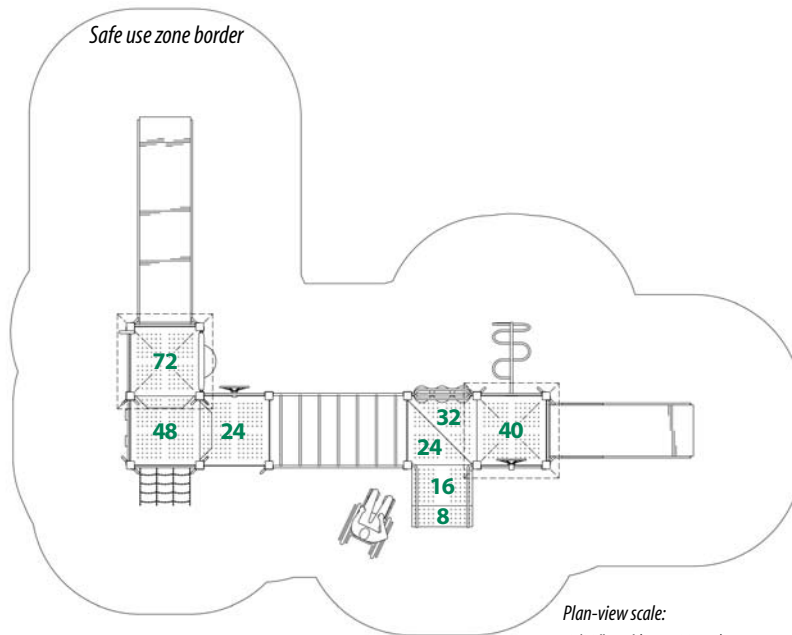

Deck Heights:

- 8" 205mm
- 16" 405mm
- 24" 610mm
- 32" 815mm
- 40" 1015mm
- 48" 1220mm
- 72" 1830mm

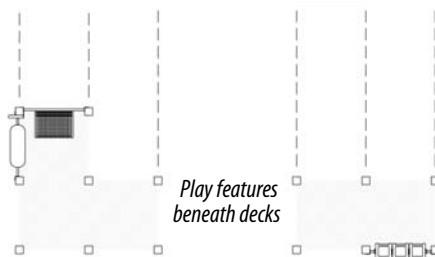



TimberForm-2 Model No. 4872-TF RePlay Model No. 4872-RP

Appropriate for Children 5 to 12 Years of Age.

Play Area, Equipment Only:
 38' x 19' (11.6m x 5.8m)

Minimum Safe Use Zone:
 50' x 31' (15.3m x 9.5m)

Accessibility Profile:

- 16 Total Play Components
- 12 Elevated Play Components
 (6 Accessible)
- 4 Ground Level Play Components
 (4 Accessible)

Colors Illustrated:

- Accessories:** Burgundy
- Decks:** SofDek Plastic-coated
 Perforated Steel, Brown
- Plastic:** Tan

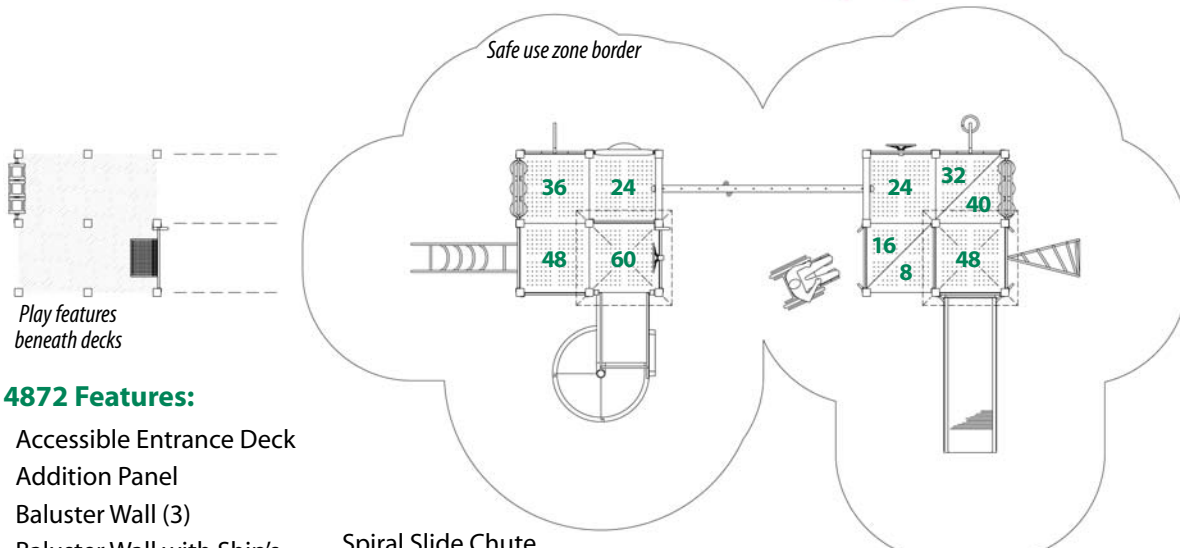
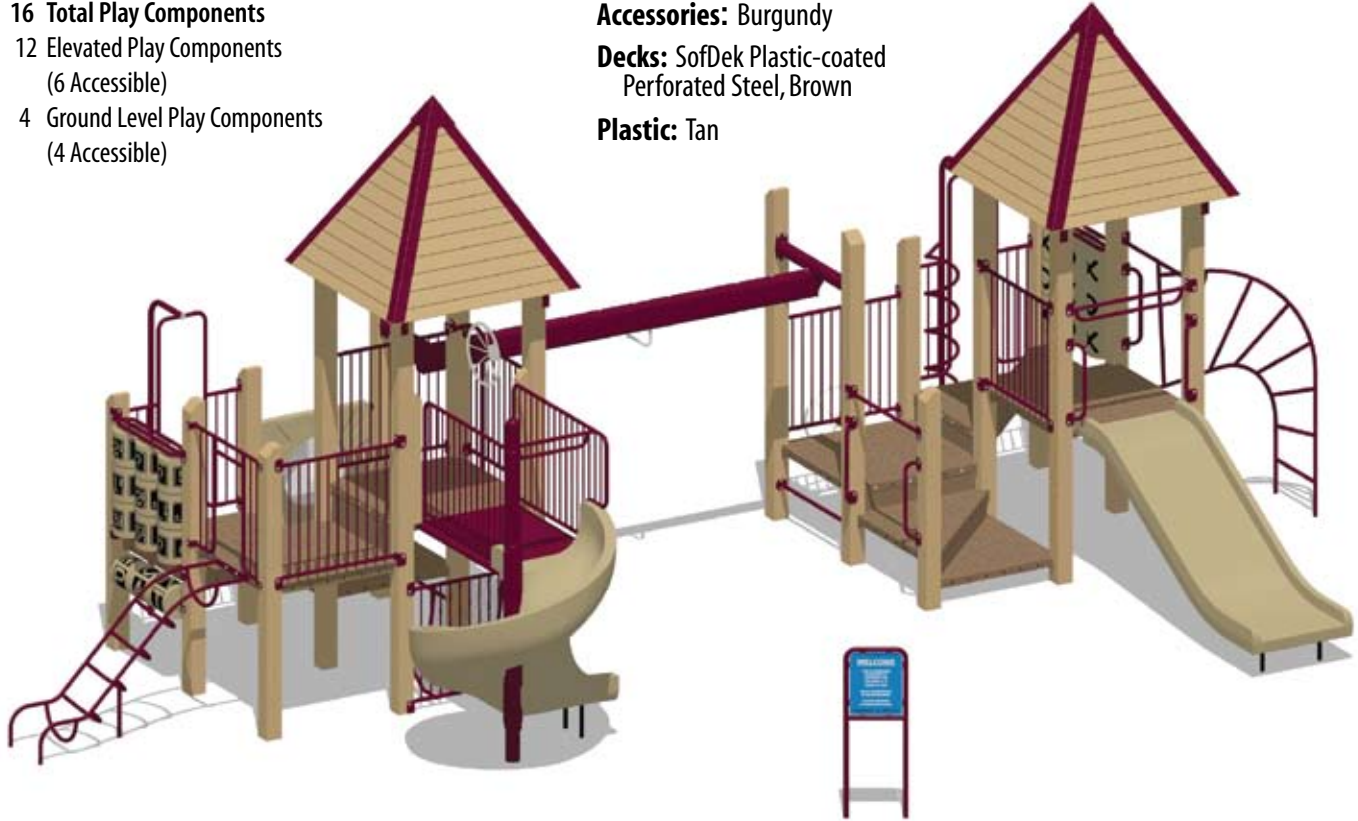

Plan-view scale: 3/32" = 1' (1 = 133mm)

4872 Features:

- Accessible Entrance Deck
- Addition Panel
- Baluster Wall (3)
- Baluster Wall with Ship's Wheel (2)
- Coil Climber
- Convex/Flat Mirror Panel
- Firefighter's Pole
- Kid's bench
- Loop Climber
- Spelling Panel
- Spiral Slide Chute
- Talk Tube
- Tic-Tac-Toe
- Track Ride, 12' (366cm)
- Twisting Climber
- Welcome/Rules Sign
- Wide Chute
- Wood Roof (2)

Deck Heights:

- 8" 205mm
- 12" 305mm
- 16" 405mm
- 24" 610mm
- 32" 815mm
- 36" 915mm
- 40" 1015mm
- 48" 1220mm
- 60" 1525mm



WARNING

METAL PLAYING SURFACES CAN BECOME DANGEROUSLY HOT WHEN EXPOSED TO DIRECT SUNLIGHT. OWNERS/OPERATORS MUST WARN USERS THAT SERIOUS THERMAL BURNS MAY RESULT WHEN BARE SKIN COMES IN CONTACT WITH HOT METAL.

TimberForm®

Play Area, Equipment Only: Appropriate for Children 5 to 12 Years of Age.
46' x 23' (14.1m x 7.1m)

TimberForm-2 Model No. 4877-TF
Replay Model No. 4877-RP

Minimum Safe Use Zone:
58' x 35' (17.7m x 10.7m)

Accessibility Profile:

- 12 Total Play Components
- 9 Elevated Play Components (9 Accessible)
- 3 Ground Level Play Components (3 Accessible)

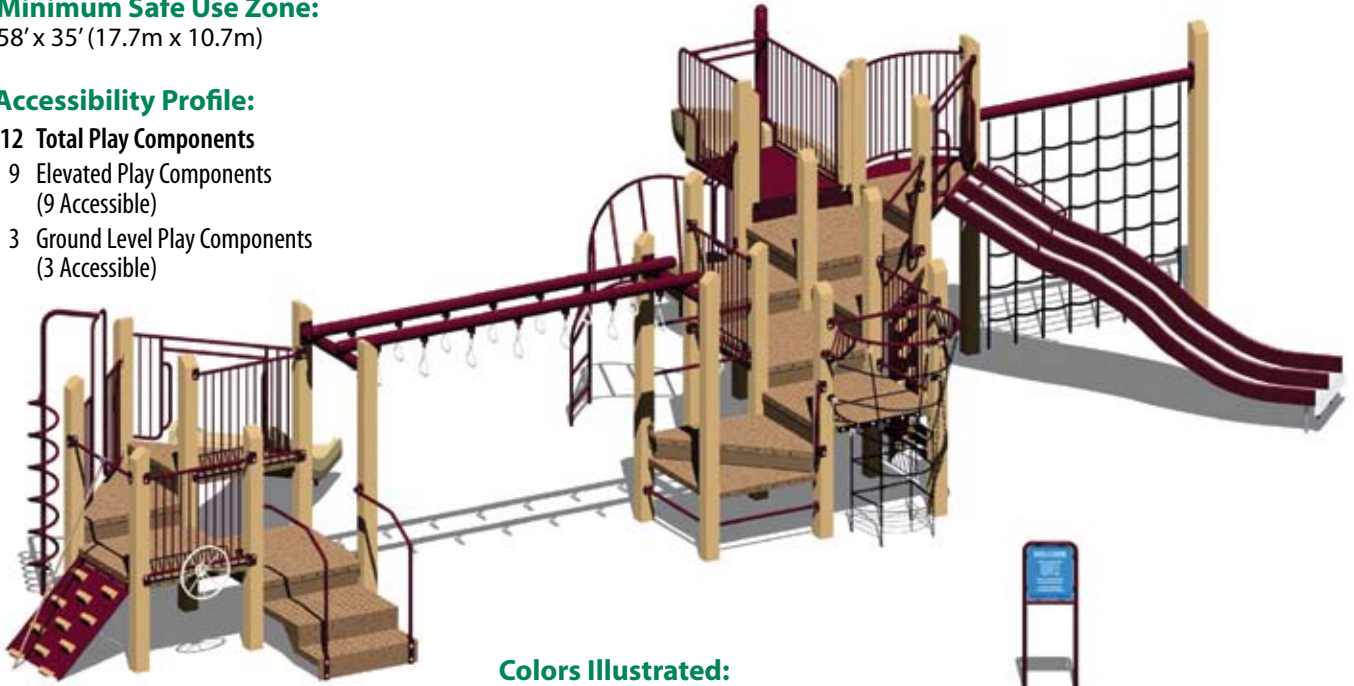

Colors Illustrated:

Accessories: Burgundy

Decks: SofDek Plastic-coated
Perforated Steel, Brown

4877 Features:

- Abacus
- Accessible Transfer Station, 8" (21cm) Riser
- Baluster Wall (3)
- Baluster Wall with Ship's Wheel
- Block Climber
- Cargo Net Climber
- Climbing Ramp
- Coil Climber
- Funnel Net Climber
- Lookout Platform, Baluster Wall
- Ring Beam, Double, 12' (366cm)
- Spiral Slide Chute
- Twisting Climber
- Welcome/Rules Sign
- Wide Chute
- Wide Wave Chute with Center Rail, Stainless Steel with 6" (15cm) Rails

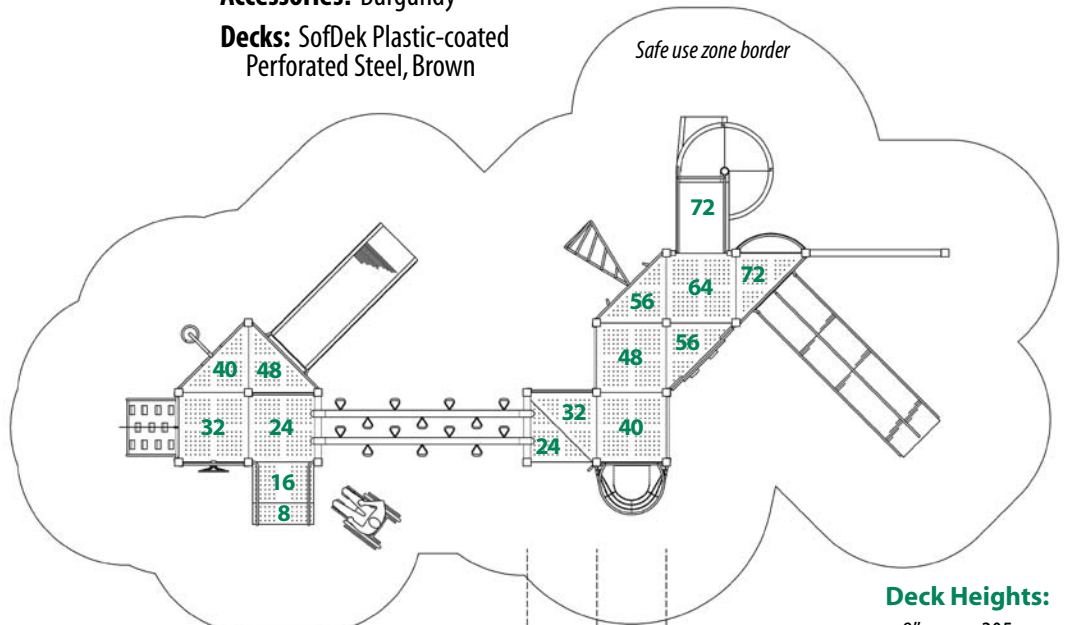

Plan-view scale: 3/32" = 1' (1 = 133mm)

Play features beneath decks

Deck Heights:

- 8" 205mm
- 16" 405mm
- 24" 610mm
- 32" 815mm
- 40" 1015mm
- 48" 1220mm
- 56" 1420mm
- 64" 1625mm
- 72" 1830mm



Need CAD details or specifications? Contact us at HQ@timberform.com



TimberForm-2 Model No. 4881-TF
RePlay Model No. 4881-RP

Appropriate for Children 5 to 12 Years of Age.

Play Area, Equipment Only:
 31' x 21' (9.5m x 6.5m)

Minimum Safe Use Zone:
 43' x 33' (13.2m x 10.1m)

Accessibility Profile:

- 13 Total Play Components**
- 10 Elevated Play Components (10 Accessible)
- 3 Ground Level Play Components (3 Accessible)



Colors Illustrated:

Accessories: Evergreen

Decks: SofDek Plastic-coated Perforated Steel, Brown

Plastic: Tan

Play features beneath decks

4881 Features:

- Abacus
- Accessible Transfer Station, 8" (21cm) Riser
- Arch Ring Climber
- Baluster Wall (3)
- Chime Wall
- Climbing Ramp
- Kid's Bench
- Lookout Platform with Ship's Wheel
- Ribbon Slide
- Spelling Panel
- Spiral Slide Chute
- Storefront Countertop
- Super Ring Beam, 8' (244cm)
- Tunnel Crawl, Clear Plastic
- Welcome/Rules Sign
- Wide Chute

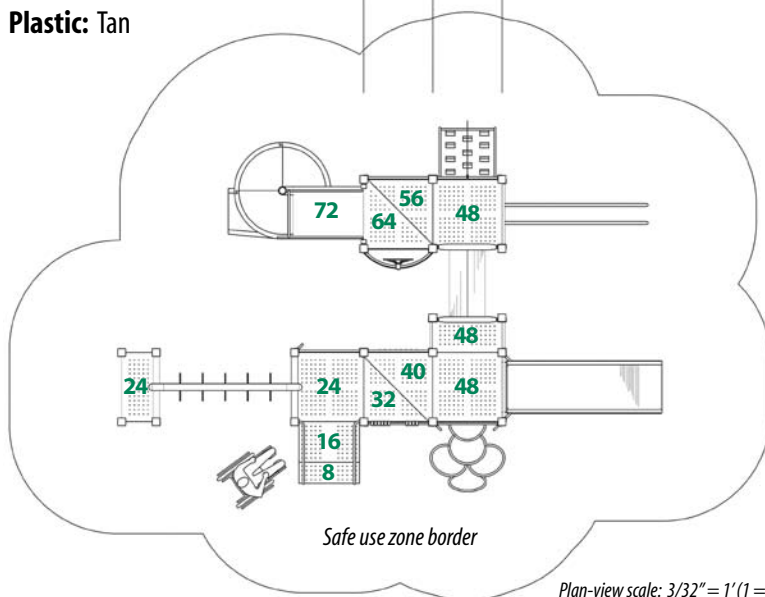

Deck Heights:

8"	205mm	32"	815mm	56"	1420mm
16"	405mm	40"	1015mm	64"	1625mm
24"	610mm	48"	1220mm	72"	1830mm





WARNING

METAL PLAYING SURFACES CAN BECOME DANGEROUSLY HOT WHEN EXPOSED TO DIRECT SUNLIGHT. OWNERS/OPERATORS MUST WARN USERS THAT SERIOUS THERMAL BURNS MAY RESULT WHEN BARE SKIN COMES IN CONTACT WITH HOT METAL.

TimberForm®

Play Area, Equipment Only: Appropriate for Children 5 to 12 Years of Age.
44' x 26' (13.5m x 8.0m)

Minimum Safe Use Zone:
56' x 38' (17.1m x 11.6m)

Accessibility Profile:

- 13 Total Play Components
- 9 Elevated Play Components (9 Accessible)
- 4 Ground Level Play Components (4 Accessible)

TimberForm-2 Model No. 4885-TF
Replay Model No. 4885-RP

Colors Illustrated:

- Accessories:** Brown
- Decks:** SofDek Plastic-coated Perforated Steel, Brown
- Plastic:** Tan

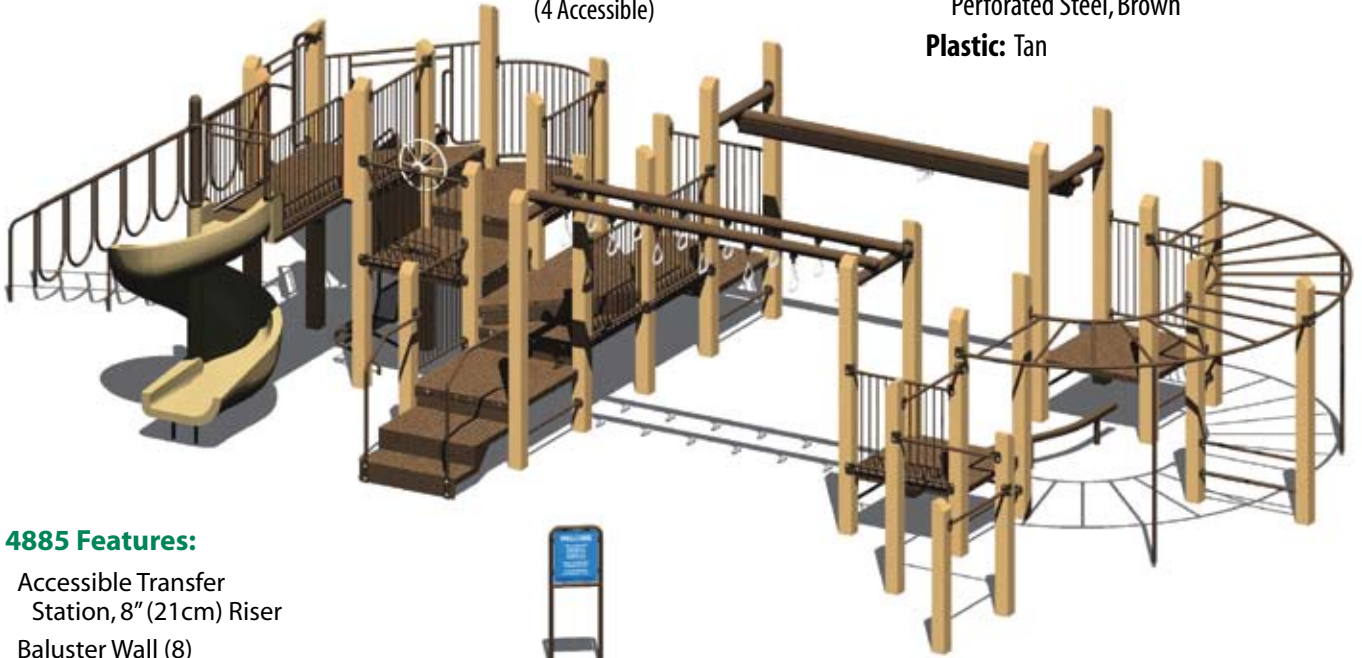

4885 Features:

- Accessible Transfer Station, 8" (21cm) Riser
- Baluster Wall (8)
- Baluster Wall with Ship's Wheel
- Chinning Bar (3)
- Curved Balance Beam
- Curved Overhead Ladder (2)
- Kid's Bench

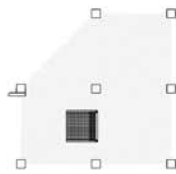

Play features beneath decks

- Lookout Platform, Baluster Wall
- Loop Climber with Handrails
- Ring Beam, Double, 12' (366cm)
- Spiral Slide Chute
- Talk Tube
- Track Ride, 12' (366cm)
- Welcome/Rules Sign
- Wide Chute with Center Rail, Stainless Steel with 6" (15cm) Rails

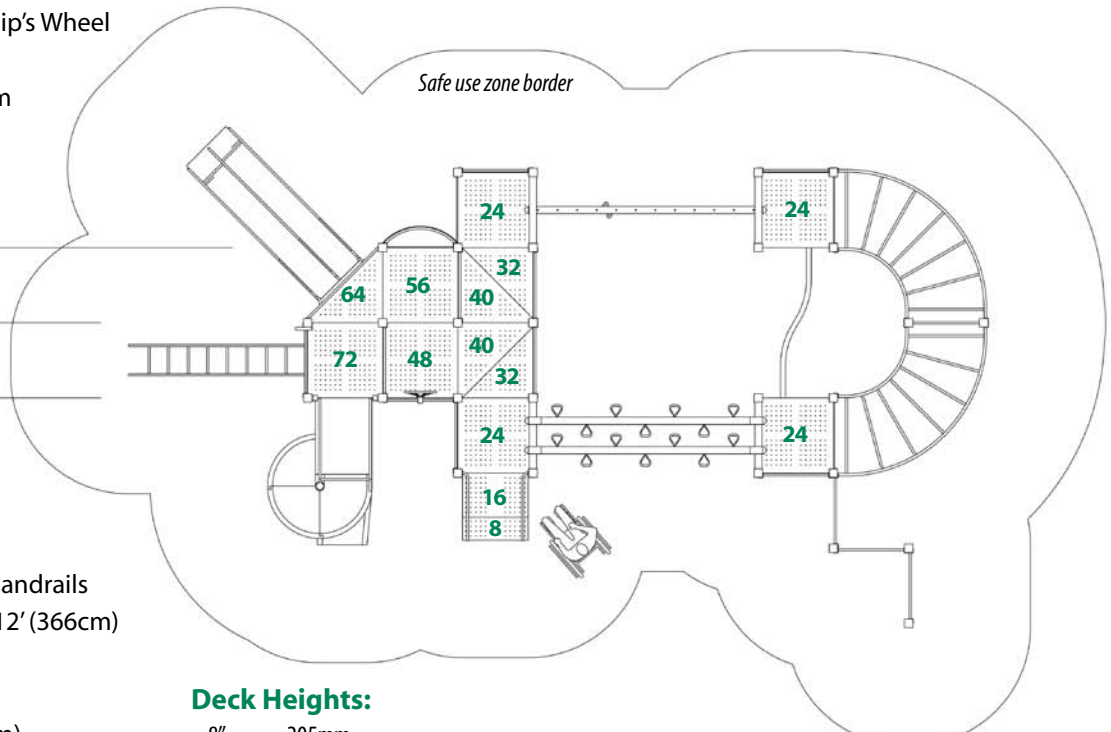

Deck Heights:

8"	205mm
16"	405mm
24"	610mm
32"	815mm
40"	1015mm
48"	1220mm
56"	1420mm
64"	1625mm
72"	1830mm

Plan-view scale: 3/32" = 1' (1 = 133mm)





TimberForm-2 Model No. 4890-TF Appropriate for Children 5 to 12 Years of Age.
RePlay Model No. 4890-RP

Play Area, Equipment Only:
 34' x 26' (10.4m x 8.0m)

Minimum Safe Use Zone:
 46' x 38' (14.1m x 11.6m)

Accessibility Profile:

- 19 Total Play Components
- 14 Elevated Play Components
 (14 Accessible)
- 5 Ground Level Play Components
 (5 Accessible)

Colors Illustrated:

Accessories: Evergreen

Decks: SofDek Plastic-coated
 Perforated Steel, Brown

Plastic: Yellow



4890 Features:

- Abacus
- Accessible Transfer Station, 8" (21cm) Riser
- Addition Panel
- Arch Ring Climber
- Baluster Wall (6)
- Baluster Wall with Ship's Wheel
- Bubble Panel
- Cargo Net
- Kid Spinner
- Overhead Safety Ladder
- School Bus with Wheel and Wood Seats
- Spelling Panel, Baluster Wall
- Spiral Slide Chute
- Storefront Countertop
- Suspension Bridge, Perforated Steel, with Baluster Walls
- Talk Tube
- Tot Slide Chute, Curved
- Track Ride, 8' (244cm)
- Tunnel Crawl, Clear Plastic
- Vertical Loop Climber
- Vertical Safety Climber
- Welcome/Rules Sign
- Wood Roof

Play features beneath decks

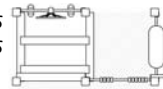

Play Area, Kid Spinner Only:
 2' x 2' (0.7m x 0.7m)

Minimum Safe Use Zone:
 14' x 14' (4.3m x 4.3m)

Safe use zone border



Safe use zone border

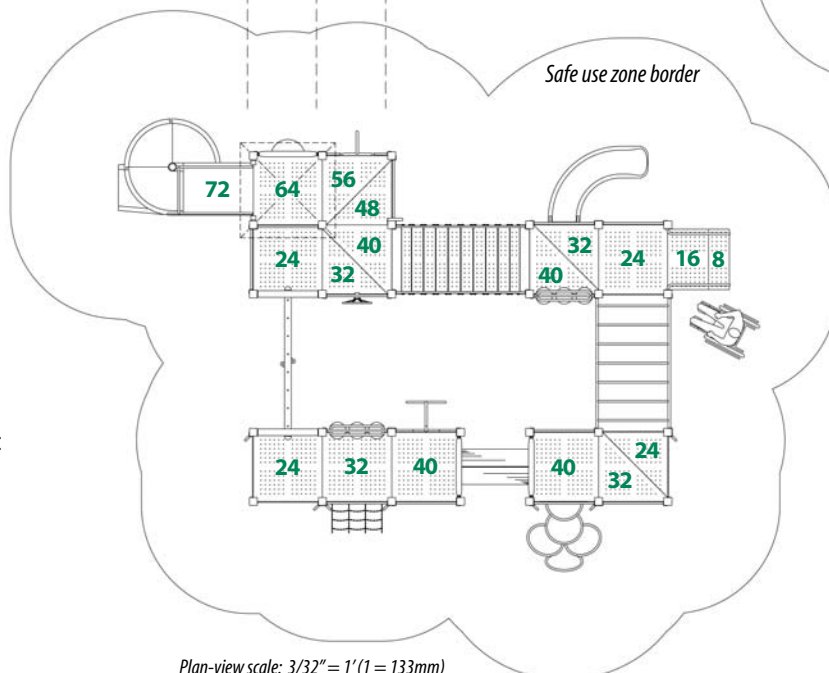

Deck Heights:

- 8" 205mm
- 16" 405mm
- 24" 610mm
- 32" 815mm
- 40" 1015mm
- 48" 1220mm
- 56" 1420mm
- 64" 1625mm
- 72" 1830mm

Plan-view scale: 3/32" = 1' (1 = 133mm)





WARNING

METAL PLAYING SURFACES CAN BECOME DANGEROUSLY HOT WHEN EXPOSED TO DIRECT SUNLIGHT. OWNERS/OPERATORS MUST WARN USERS THAT SERIOUS THERMAL BURNS MAY RESULT WHEN BARE SKIN COMES IN CONTACT WITH HOT METAL.

Play Area, Equipment Only: Appropriate for Children 5 to 12 Years of Age.
34' x 27' (10.4m x 8.3m)

TimberForm-2 Model No. 4894-TF
Replay Model No. 4894-RP

Minimum Safe Use Zone:
46' x 39' (14.1m x 11.9m)

Accessibility Profile:

- 21 Total Play Components
- 16 Elevated Play Components (16 Accessible)
- 5 Ground Level Play Components (5 Accessible)



Deck Heights:

8"	205mm	48"	1220mm
16"	405mm	56"	1420mm
24"	610mm	64"	1625mm
32"	815mm	72"	1830mm
40"	1015mm		

Colors Illustrated:

Accessories: Regal Blue

Decks: SofDek Plastic-coated
Perforated Steel, Brown

Plastic: Tan

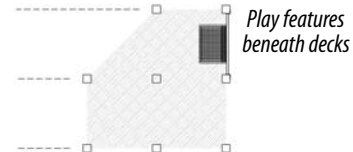
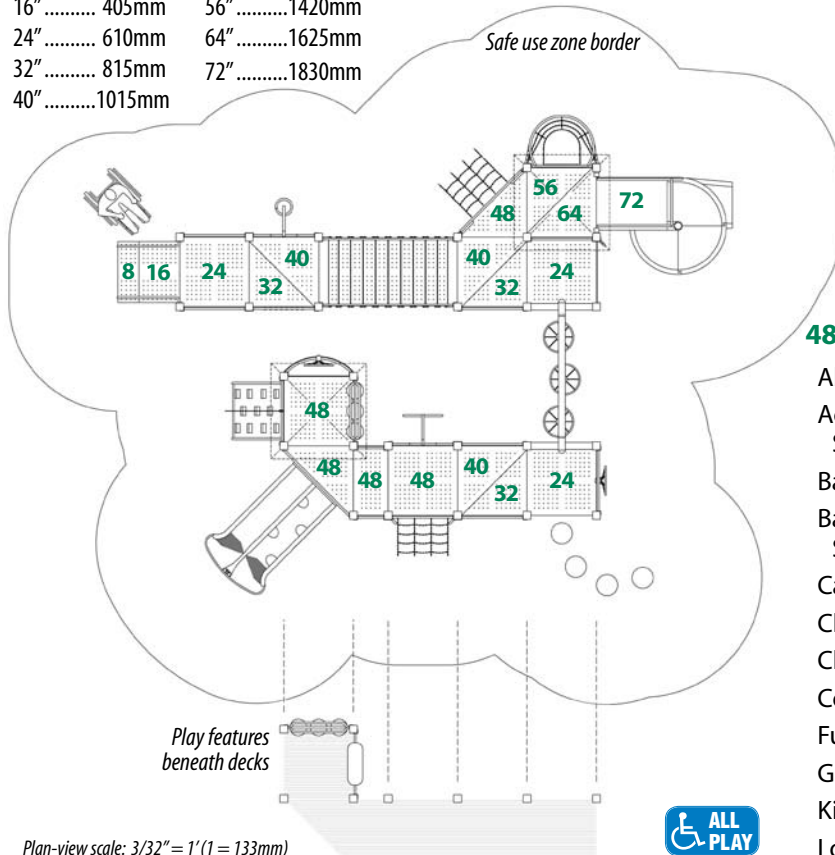

4894 Features:

- Abacus
- Accessible Transfer Station, 8" (21 cm) Riser
- Baluster Wall (4)
- Baluster Wall with Ship's Wheel
- Cargo Net (2)
- Chime Wall
- Climbing Ramp
- Coil Climber
- Funnel Net Climber
- Gear Panel
- Kid's Bench
- Lookout Platform with Ship's Wheel
- Maze Panel
- Spelling Panel
- Spiral Slide Chute
- Stepping Pad (4)
- Storefront Countertop
- Suspension Bridge, Steel, with Baluster Walls
- Tic-Tac-Toe
- Vertical Loop Climber
- Welcome/Rules Sign
- Wheel Beam, 8' (244cm)
- Wide Chute, Wave/Slalom
- Wood Roof (2)

Plan-view scale: 3/32" = 1' (1 = 133mm)





Play Area, Equipment Only: Appropriate for Children 5 to 12 Years of Age.
39' x 39' (11.9m x 11.9m)

TimberForm-2 Model No. 4898-TF
Replay Model No. 4898-RP

Minimum Safe Use Zone:
51' x 51' (15.6m x 15.6m)



Colors Illustrated:

Accessories: Evergreen

Decks: SofDek Plastic-coated
Perforated Steel, Brown

Plastic: Tan

Accessibility Profile:

- 17 Total Play Components
- 13 Elevated Play Components (13 Accessible)
- 4 Ground Level Play Components (4 Accessible)

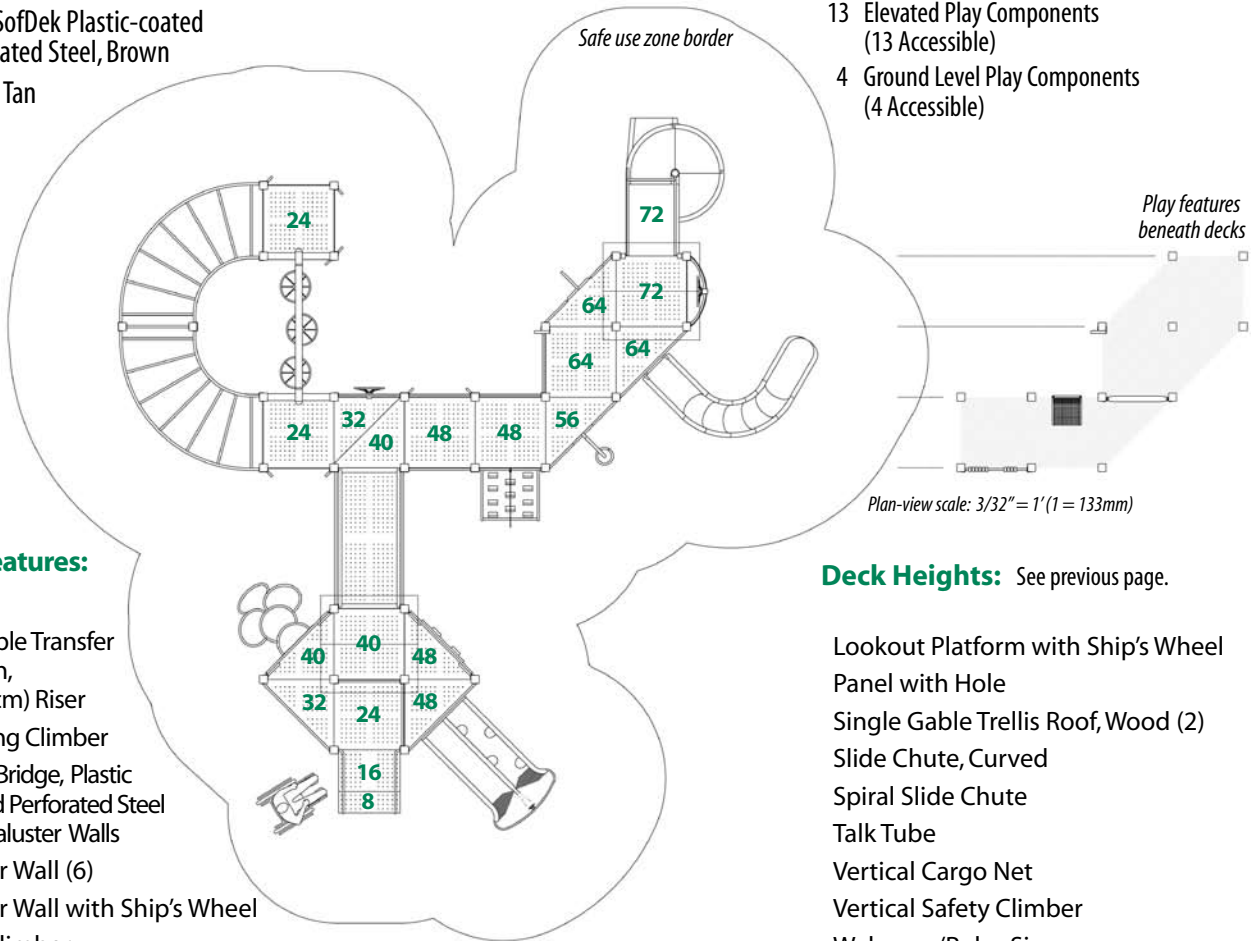

4898 Features:

- Abacus
- Accessible Transfer Station, 8" (21cm) Riser
- Arch Ring Climber
- Arched Bridge, Plastic Coated Perforated Steel with Baluster Walls
- Baluster Wall (6)
- Baluster Wall with Ship's Wheel
- Block Climber
- Climbing Ramp
- Coil Climber

- Curved Overhead Ladder (2)
- Kid's Bench

Deck Heights: See previous page.

- Lookout Platform with Ship's Wheel
- Panel with Hole
- Single Gable Trellis Roof, Wood (2)
- Slide Chute, Curved
- Spiral Slide Chute
- Talk Tube
- Vertical Cargo Net
- Vertical Safety Climber
- Welcome/Rules Sign
- Wheel Beam, 8' (244cm)
- Wide Chute, Wave/Slalom



Stand Alone Play Events

Separates



85-A



85-B



85-C



85-D



85-E



85-F



85-G



85-H

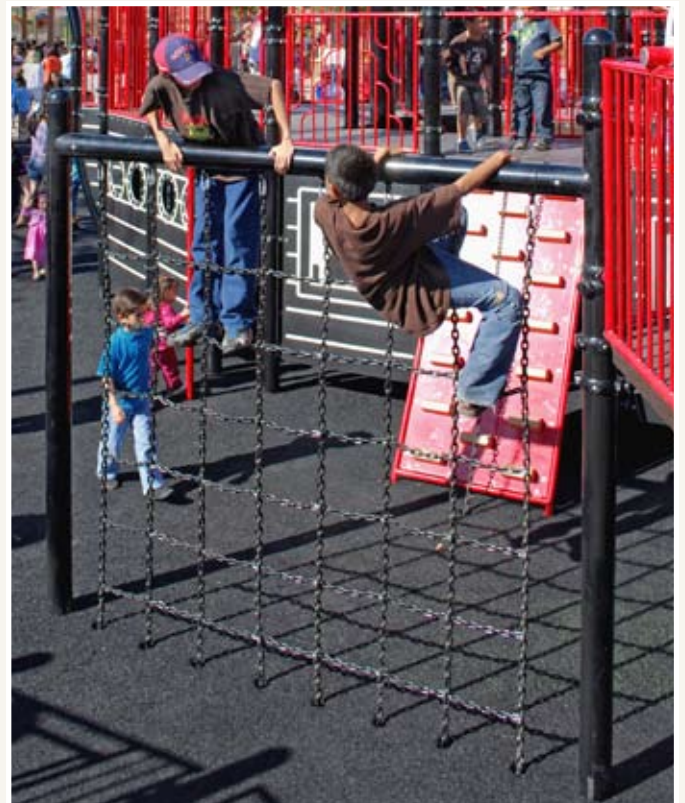

85-I

Separates

Stand Alone Play Events



86-A



86-B



86-C



86-D



86-E



86-F



86-I



86-G



86-H



86-J











86-K

WARNING

METAL PLAYING SURFACES CAN BECOME DANGEROUSLY HOT WHEN EXPOSED TO DIRECT SUNLIGHT. OWNERS/OPERATORS MUST WARN USERS THAT SERIOUS THERMAL BURNS MAY RESULT WHEN BARE SKIN COMES IN CONTACT WITH HOT METAL.

Separates

<p>Spring Rider 3881-01 "Cycle"</p> 	<p>Spring Rider 3884-01 "Sea Horse"</p> 	<p>Spring Rider 3889-01 "Pony"</p> 	<p>Spring Rider 3892-01 "Minnie Minnow"</p> 
<p>Spring Rider 3894-01 "Happy Hen"</p> 	<p>Spring Rider 3897-01 "Tiny Tug"</p> 	<p>Spring Rider 3899-01 "Little Locomotive"</p> 	<p>Spring Rider 3891-01  "Benny Boa" Accessible*</p>  <p>Includes Braille message inside.</p>

Single Spring Riders, Equipment Only: 3' x 2' (1.0m x 0.7m) **Minimum Safe Use Zone:** 15' diameter. (4.6m dia.)

<p>Spring Rider See-Saw 3870-2</p>  <p>Equipment Only: 11' x 3' (3.4m x 1.0m)</p> <p>Minimum Safe Use Zone: 23' x 15' (7.1m x 4.6m)</p>	<p>Timber See-Saw 1682</p>  <p>Equipment Only: 14' x 2' (4.3m x 0.7m)</p> <p>Minimum Safe Use Zone: 26' x 14' (8.0m x 4.3m)</p>
---	--

<p>Tandem Spring Rider See-Saw 3870-4</p>  <p>Equipment Only: 13' x 3' (4.0m x 1.0m)</p> <p>Minimum Safe Use Zone: 25' x 15' (7.7m x 4.6m)</p>	<p>Two additional "Themed" Spring Rider See-Saws appear on pages 15 and 21 of this catalog.</p> <p>"Mermaids" 3873-2</p>  <p>"Dalmatians" 3872-2</p> 
--	--

Separates



WARNING

INSTALLATION OVER A HARD SURFACE SUCH AS CONCRETE, ASPHALT OR PACKED EARTH MAY RESULT IN SERIOUS INJURY OR DEATH FROM FALLS.

TimberForm Double Belt Swing 1561-2

Also available: Double Tot Swing 1562-2



Equipment Only: 12' x 12' (3.7m x 3.7m)

Minimum Safe Use Zone: 24' x 30' (7.4m x 9.2m)

TimberForm TyreSwing™ 1561-TS



Equipment Only: 16' x 11' (4.9m x 3.4m)

Minimum Safe Use Zone: 28' x 21' (8.6m x 6.5m)

TimberForm Double Belt / Double Tot Swing 1563-4

Also available with all Tot or Belt Seats.

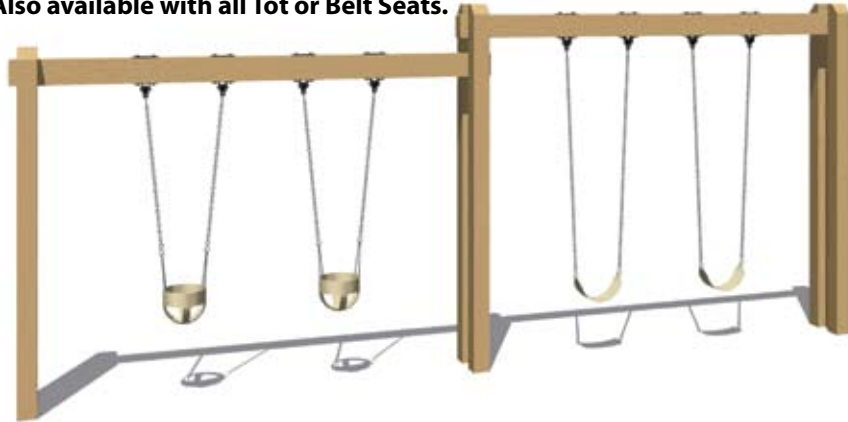

Equipment Only: 23' x 14' (7.1m x 4.3m)

Minimum Safe Use Zone: 35' x 34' (10.7m x 10.4m)

Belt Seat 1669*



TyreSwing™ Apparatus 1620*



Tot Seat 1668*



Double Belt Swing 1581-2

Also available: Double Tot Swing 1582-2

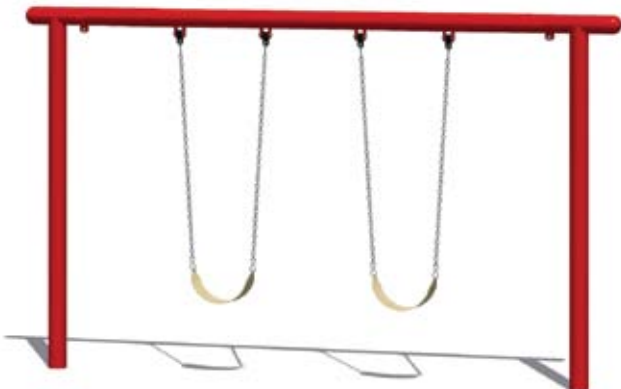

Equipment Only: 13' x 11' (4.0m x 3.4m)

Minimum Safe Use Zone: 24' x 28' (7.4m x 8.6m)

Double Belt Swing 1571-2

Also available: Double Tot Swing 1572-2



Equipment Only: 12' x 13' (3.7m x 4.0m)

Minimum Safe Use Zone: 24' x 32' (7.4m x 9.8m)

* Replacement Swing Seats and TyreSwing apparatus are available only for use on existing TimberForm & PipeLine structures.

WARNING

METAL PLAYING SURFACES CAN BECOME DANGEROUSLY HOT WHEN EXPOSED TO DIRECT SUNLIGHT. OWNERS/OPERATORS MUST WARN USERS THAT SERIOUS THERMAL BURNS MAY RESULT WHEN BARE SKIN COMES IN CONTACT WITH HOT METAL.

Separates

TyreSwing™ 1571-TS



Equipment Only: 15' x 11' (4.6m x 3.4m)

Minimum Safe Use Zone: 27' x 22' (8.3m x 6.8m)

Single Belt / Single Tot Gullwing Swing 1593-2



Equipment Only: 13' x 13' (4.0m x 4.0m)

Minimum Safe Use Zone: 25' x 32' (7.7m x 9.8m)

Double Belt / Single Tot Swing 1583-3

Also available with all Tot or Belt Seats.

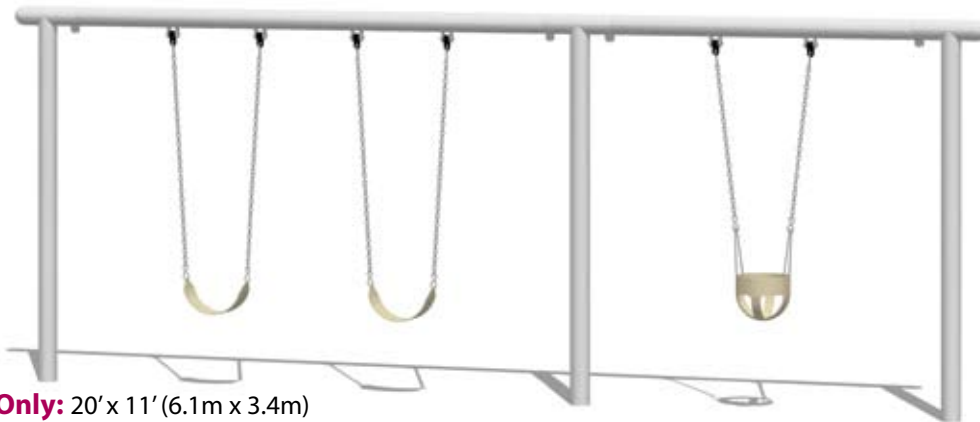

Equipment Only: 20' x 11' (6.1m x 3.4m)

Minimum Safe Use Zone: 31' x 28' (9.5m x 8.6m)

Double Belt / Double Tot Swing 1573-4

Also available with all Tot or Belt Seats.



Equipment Only: 23' x 13' (7.1m x 4.0m)

Minimum Safe Use Zone: 35' x 32' (10.7m x 9.8m)

Separates



WARNING

INSTALLATION OVER A HARD SURFACE SUCH AS CONCRETE, ASPHALT OR PACKED EARTH MAY RESULT IN SERIOUS INJURY OR DEATH FROM FALLS.

Accessible Swing 1572-1-ADA



Equipment Only: 8' x 5' (2.5m x 1.6m)

Minimum Safe Use Zone: 20' x 24' (6.1m x 7.4m)

Pivot-Pad Bridge 1995-12-81-PL



Equipment Only: 13' x 5' (4.0m x 1.6m)

Minimum Safe Use Zone: 25' x 17' (7.7m x 5.2m)

Double Belt / Double Tot / Accessible Swing 1573-5-ADA

Also available with all Tot or Belt Seats plus Accessible Seat.



Equipment Only: 30' x 13' (9.2m x 4.0m)

Minimum Safe Use Zone: 42' x 32' (12.9m x 9.8m)



We can supply long length swing structures with multiple bays. Choose the number of Belt, Tot or Accessible Seats you require and we'll create a PipeLine or TimberForm swing structure to fit your site.

WARNING

METAL PLAYING SURFACES CAN BECOME DANGEROUSLY HOT WHEN EXPOSED TO DIRECT SUNLIGHT. OWNERS/OPERATORS MUST WARN USERS THAT SERIOUS THERMAL BURNS MAY RESULT WHEN BARE SKIN COMES IN CONTACT WITH HOT METAL.

Separates

**KidSpinner™
1630-5-22-PL**



Equipment Only:
2' x 2' (0.7m x 0.7m)

Minimum Safe Use Zone:
14' x 14' (4.3m x 4.3m)

Spiral Spinner 1630-6-11-PL

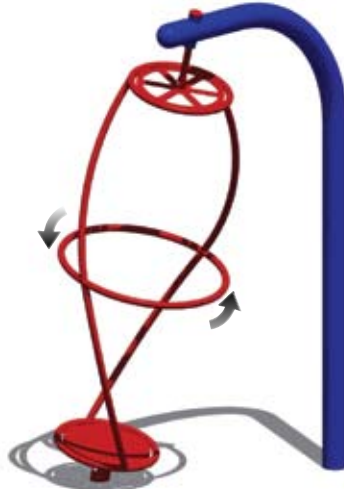

Equipment Only:
5' x 4' (1.6m x 1.3m)

Minimum Safe Use Zone:
17' x 16' (5.2m x 4.9m)

WhirlAround™ 1630-6-12-PL



Equipment Only:
6' x 6' (1.9m x 1.9m)

Minimum Safe Use Zone:
18' x 18' (5.5m x 5.5m)

**Stepping Pad(s)
1602-01-00**



Heights
May Vary

**Equipment Space and
Minimum Safe Use Zone:** Varies

(Five Pads Shown)

Spinners

With a slight leg thrust, these Spinners turn smoothly and freely on long-life bearings.



**Sloped Spinner
1630-1-20-PL**



Equipment Only:
2' x 2' (0.7m x 0.7m)

**Seat Spinner
1630-1-21-PL**



Minimum Safe Use Zone:
14' x 14' (4.3m x 4.3m)

**Tunnel Crawl, Stainless
Steel 1918-00-03-PL**



Equipment Only:
5' x 5' (1.6m x 1.6m)

Minimum Safe Use Zone:
17' x 17' (5.2m x 5.2m)

**Tunnel Crawl
1919-00-01-PL**



Equipment Only:
5' x 5' (1.6m x 1.6m)

Minimum Safe Use Zone:
17' x 17' (5.2m x 5.2m)

Tunnel Crawl, Clear 1919-20-01-PL



U.S. Patent Des. 413,370

Equipment Only:
5' x 5' (1.6m x 1.6m)

Minimum Safe Use Zone:
17' x 17' (5.2m x 5.2m)

Separates



WARNING

INSTALLATION OVER A HARD SURFACE SUCH AS CONCRETE, ASPHALT OR PACKED EARTH MAY RESULT IN SERIOUS INJURY OR DEATH FROM FALLS.

TimberForm SpringPad™ 1600



Equipment Only:

4' x 4' (1.3m x 1.3m)

Minimum Safe Use Zone:

18' x 18' (5.5m x 5.5m)

SpringPad™ 1600-03 Plastic-coated Perforated Steel



Equipment Only:

4' x 4' (1.3m x 1.3m)

Minimum Safe Use Zone:

18' x 18' (5.5m x 5.5m)

TimberForm White Water Raft 1601



Equipment Only:

8' x 5' (2.5m x 1.6m)

Minimum Safe Use Zone:

22' x 19' (6.8m x 5.8m)

TimberForm Double Arch Climber 1672

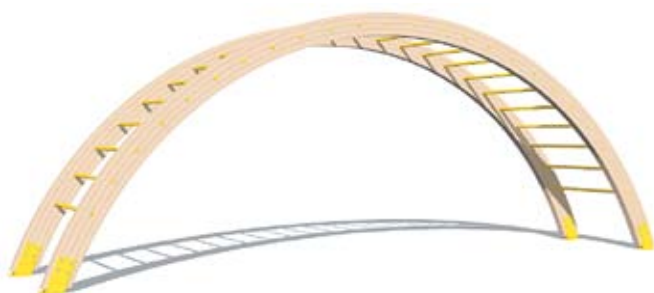

Equipment Only:

22' x 5' (6.8m x 1.6m)

Minimum Safe Use Zone:

34' x 17' (10.4m x 5.2m)

TimberForm Triple Arch Climber 1676

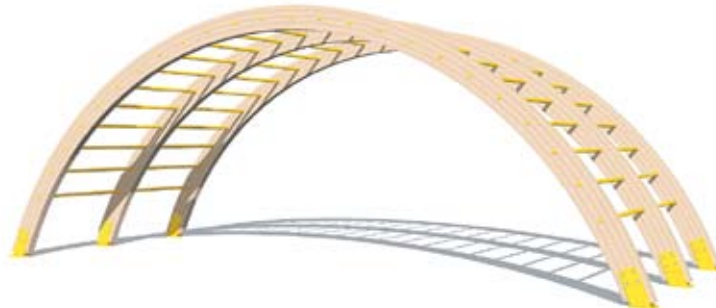

Equipment Only:

22' x 9' (6.8m x 2.8m)

Minimum Safe Use Zone:

34' x 21' (10.4m x 6.5m)

Single Arch Net Climber 1648-6-20-PL

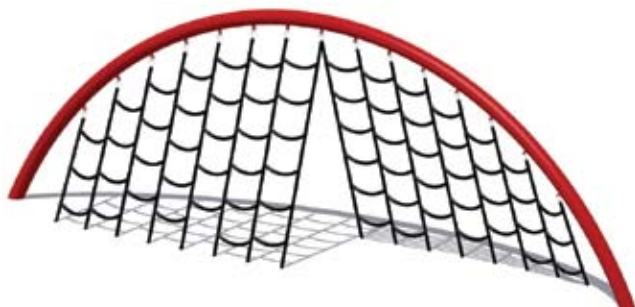

Equipment Only:

19' x 4' (5.8m x 1.3m)

Minimum Safe Use Zone:

31' x 16' (9.5m x 4.9m)

Double Arch Net Climber 1648-6-22-PL



Equipment Only:

19' x 5' (5.8m x 1.6m)

Minimum Safe Use Zone:

31' x 17' (9.5m x 5.2m)

Single Arch Loop Climber 1670-02-PL

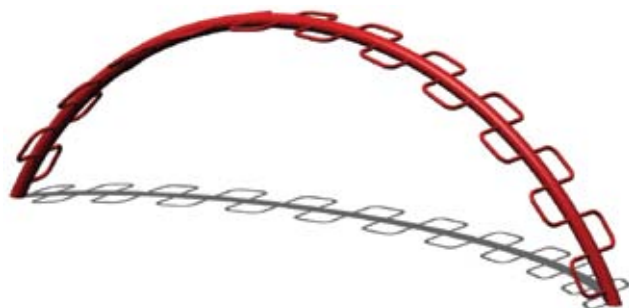

Equipment Only:

19' x 3' (5.8m x 1.0m)

Minimum Safe Use Zone:

31' x 15' (9.5m x 4.6m)

Overhead Arch Ladder with Handrails 1693-11-PL



Equipment Only:

13' x 3' (4.0m x 1.0m)

Minimum Safe Use Zone:

25' x 15' (7.7m x 4.6m)

WARNING

METAL PLAYING SURFACES CAN BECOME DANGEROUSLY HOT WHEN EXPOSED TO DIRECT SUNLIGHT. OWNERS/OPERATORS MUST WARN USERS THAT SERIOUS THERMAL BURNS MAY RESULT WHEN BARE SKIN COMES IN CONTACT WITH HOT METAL.

Separates

Overhead Arch Ladder 1693

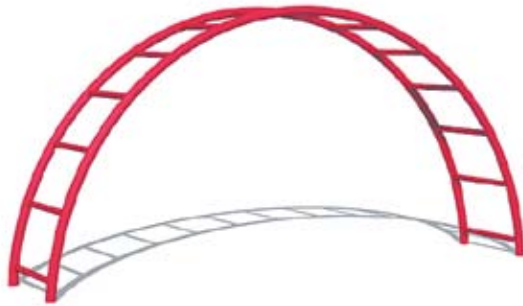

Equipment Only:
9' x 2' (2.8m x 0.7m)

Minimum Safe Use Zone:
21' x 14' (6.5m x 4.3m)

Log Roll™ 1612-PL



Equipment Only:
5' x 2' (1.6m x 0.7m)

Minimum Safe Use Zone:
17' x 14' (5.2m x 4.3m)

TimberForm Log Roll™ 1615-01-TF



Equipment Only:
5' x 2' (1.6m x 0.7m)

Minimum Safe Use Zone:
17' x 14' (5.2m x 4.3m)

Ring Beam 1993-12-00-PL



Equipment Only:
13' x 5' (4.0m x 1.6m)

Minimum Safe Use Zone:
25' x 17' (7.7m x 5.2m)

Track Ride 1992-12-00-PL

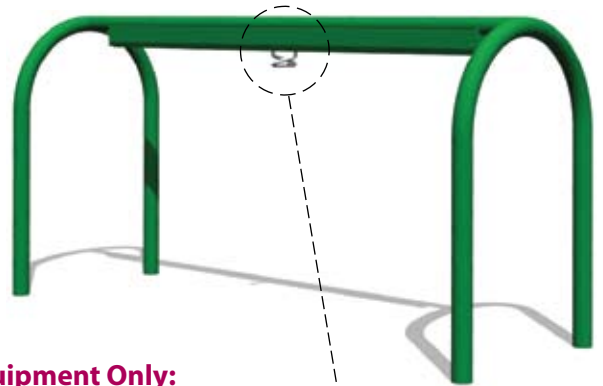

Equipment Only:
13' x 5' (4.0m x 1.6m)

Minimum Safe Use Zone:
25' x 17' (7.7m x 5.2m)

'S' Curved Overhead Ladder 1985-00-PL

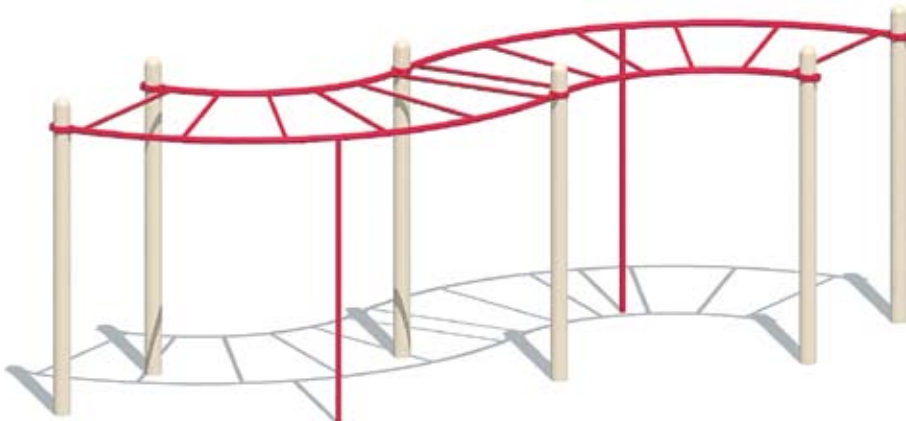

Equipment Only:
17' x 13' (5.2m x 4.0m)

Minimum Safe Use Zone:
29' x 25' (8.9m x 7.7m)



Track Ride Mechanism Detail

- ✓ Unique Ergonomic Checkered Grip
- ✓ Solid Aluminum Chassis
- ✓ Smooth, Long-life Bearings
- ✓ Quiet Operation

Separates



WARNING

INSTALLATION OVER A HARD SURFACE SUCH AS CONCRETE, ASPHALT OR PACKED EARTH MAY RESULT IN SERIOUS INJURY OR DEATH FROM FALLS.

Overhead Ladder 1980-8-00-PL

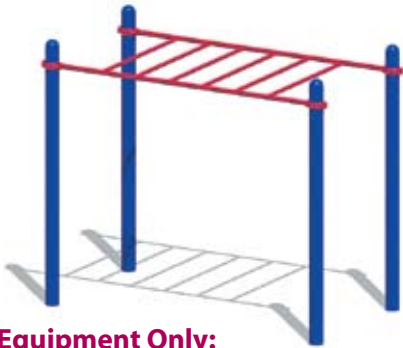

Equipment Only:
9' x 5' (2.8m x 1.6m)

Minimum Safe Use Zone:
21' x 17' (6.5m x 5.2m)

Accessible Pull Ladder 1988-8-00-PL

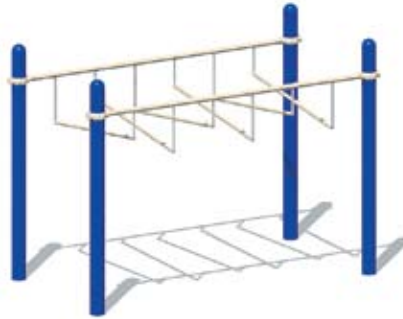

Equipment Only:
9' x 5' (2.8m x 1.6m)

Minimum Safe Use Zone:
21' x 17' (6.5m x 5.2m)

Overhead Safety Ladder 1989-00-PL



Equipment Only:
9' x 5' (2.8m x 1.6m)

Minimum Safe Use Zone:
21' x 17' (6.5m x 5.2m)

Curved Overhead Ladder 1981-00-PL

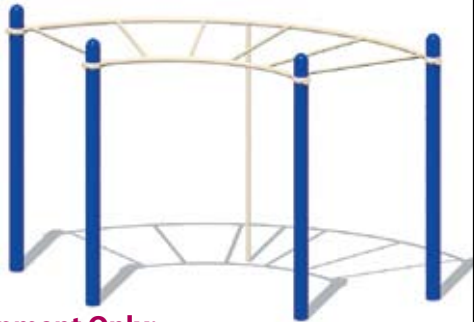

Equipment Only:
9' x 9' (2.8m x 2.8m)

Minimum Safe Use Zone:
21' x 21' (6.5m x 6.5m)

Accessible Ring Pull 1995-11-PL



Equipment Only:
5' x 1' (1.6m x 0.4m)

Minimum Safe Use Zone:
17' x 13' (5.2m x 4.0m)

Chinning Bar 1996-1-67-PL

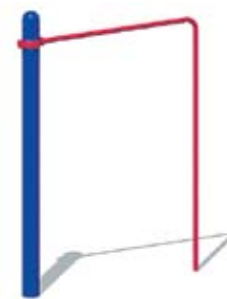

Equipment Only:
5' x 1' (1.6m x 0.4m)

Minimum Safe Use Zone:
17' x 13' (5.2m x 4.0m)

Accessible Balance Beam 1628-8-03



Equipment Only:
9' x 3' (2.8m x 1.0m)

Minimum Safe Use Zone:
21' x 15' (6.5m x 4.6m)

Parallel Bars 1695



Equipment Only:
9' x 3' (2.8m x 1.0m)

Minimum Safe Use Zone:
21' x 15' (6.5m x 4.6m)

Balance Beam, Steel 1628-12-02



Equipment Only:
12' x 1' (3.7m x 0.4m)

Minimum Safe Use Zone:
24' x 13' (7.4m x 4.0m)

Balance Beam, Timber 1628-12-01



Equipment Only:
12' x 1' (3.7m x 0.4m)

Minimum Safe Use Zone:
24' x 13' (7.4m x 4.0m)

Curved Balance Beam, Steel 1628-12-12



Equipment Only:
12' x 2' (3.7m x 0.7m)

Minimum Safe Use Zone:
24' x 14' (7.4m x 4.3m)



WARNING

METAL PLAYING SURFACES CAN BECOME DANGEROUSLY HOT WHEN EXPOSED TO DIRECT SUNLIGHT. OWNERS/OPERATORS MUST WARN USERS THAT SERIOUS THERMAL BURNS MAY RESULT WHEN BARE SKIN COMES IN CONTACT WITH HOT METAL.

Separates

About Slide Separates:

Various heights are available for all slides from 3' (915mm) to 8' (2440mm) with either Stairway with Baluster Handrails or Vertical Safety Climber entryways.



Many worldwide specifiers rely upon EN 1176 as their criteria for safe, durable playground equipment. Engineers from TÜV, an internationally recognized independent testing agency headquartered in Germany, have inspected our engineering data, factory, materials and quality control systems and products in situ. TÜV certifies TimberForm & Pipeline playground equipment to be in compliance with tough European specifications.

1940-4-14-PL

Slide Chute, Stainless Steel with 6" (15cm) Rails, Stairway with Baluster Handrails



Equipment Only:

15' x 5' (4.6m x 1.6m)



Minimum Safe Use Zone:

27' x 17' (8.3m x 5.2m)

1940-6-24-PL

Slide Chute, Stainless Steel with 6" (15cm) Rails, Vertical Safety Climber



Equipment Only:

15' x 5' (4.6m x 1.6m)



Minimum Safe Use Zone:

27' x 17' (8.3m x 5.2m)

1941-6-24-PL

Wave Chute, Stainless Steel with 6" (15cm) Rails, Vertical Safety Climber



Equipment Only:

15' x 5' (4.6m x 1.6m)



Minimum Safe Use Zone:

27' x 17' (8.3m x 5.2m)

1944-6-25-PL

Wide Wave Chute with Center Rail, Stainless Steel with 6" (15cm) Rails, Vertical Safety Climber



Equipment Only:

15' x 5' (4.6m x 1.6m)



Minimum Safe Use Zone:

27' x 17' (8.3m x 5.2m)

1953-4-11-PL

Wide Chute, Stairway with Baluster Handrails



Equipment Only:

16' x 5' (4.9m x 1.6m)



Minimum Safe Use Zone:

28' x 17' (8.6m x 5.2m)

1953-4-21-PL

Wide Chute, Vertical Safety Climber



Equipment Only:

12' x 5' (3.7m x 1.6m)



Minimum Safe Use Zone:

24' x 17' (7.4m x 5.2m)

1956-6-21-PL

Spiral Slide Chute, Vertical Safety Climber



Equipment Only:

11' x 7' (3.4m x 2.2m)



Minimum Safe Use Zone:

23' x 19' (7.1m x 5.8m)

1959-7-27-PL

Tube Chute, "S" Curved, Vertical Safety Climber



Equipment Only:

19' x 5' (5.8m x 1.6m)

Minimum Safe Use Zone:

32' x 17' (9.8m x 5.2m)

Need CAD details or specifications? Contact us at HQ@timberform.com



Custom Embankment Slide Chutes

Contact our design headquarters or your local Columbia Cascade representative for more detailed information.

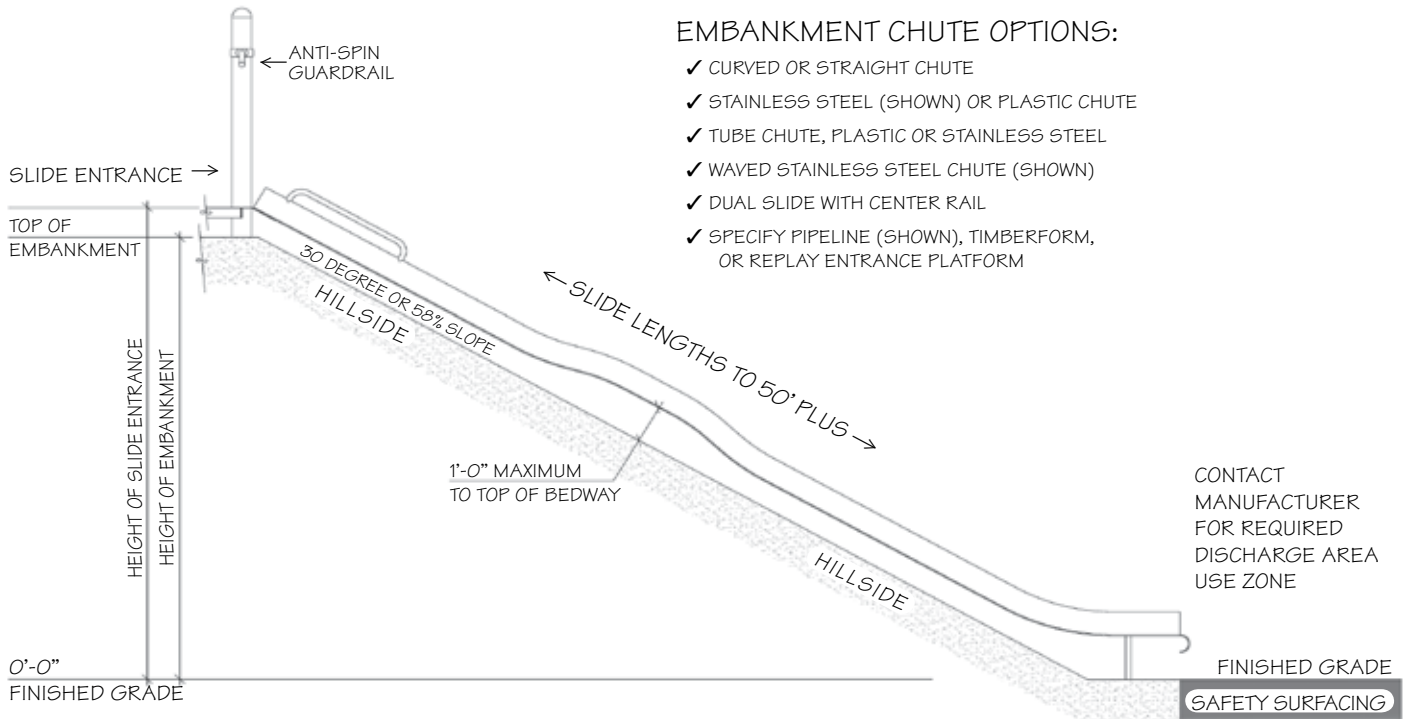

TYPICAL EMBANKMENT SLIDE CHUTE- SIDE VIEW



Curved plastic chute with PipeLine entrance platform.



Wave stainless steel dual slide with PipeLine entrance platform.

Components for Play Areas

Accessories



97-A



97-B



97-C



97-D



97-E



97-F



97-G



97-H



97-I

Accessories

Components for Play Areas



98-A



98-B



98-C



98-D



98-E



98-F



98-G



98-H



98-I

WARNING

METAL PLAYING SURFACES CAN BECOME DANGEROUSLY HOT WHEN EXPOSED TO DIRECT SUNLIGHT. OWNERS/OPERATORS MUST WARN USERS THAT SERIOUS THERMAL BURNS MAY RESULT WHEN BARE SKIN COMES IN CONTACT WITH HOT METAL.

Accessories

1613-02-38
Wood Wall



1604-01
Wood Wall
with Ship's Wheel



1613-22-38
Baluster Wall



1604-05
Baluster Wall
with Ship's Wheel



1604-27
Baluster Wall
with Two Ship's Wheels



1685-01
Lookout Platform,
Baluster Wall



1613-42-38
Welded Wire Wall



1604-09
Welded Wire Wall
with Ship's Wheel



1613-62-38
Decorative Wall



1604-13
Decorative Wall
with Ship's Wheel



1685-05
Lookout Platform,
Welded Wire Wall



1609-60
Spelling Panel,
Baluster Wall



1609-14
Spelling Panel
(horizontal mount)



1609-50
Spelling Panel
(vertical mount)



1685-09
Lookout Platform
with Ship's Wheel



1685-11
Lookout Platform
with Ship's Wheel



1606
Tic-Tac-Toe



1609-40
Addition Panel



1607-20
Convex/Flat
Mirror Panel



1617
Bubble Panel



1619
Panel with Hole



1613-00-00
Guard Rail



1613-99-13
Corner Handle

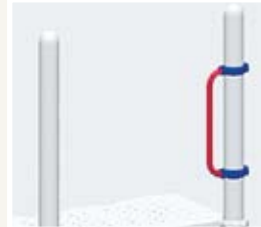

1614-46
Abacus

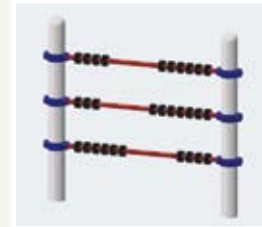

1614-48
Chime Wall



Accessories



WARNING

INSTALLATION OVER A HARD SURFACE SUCH AS CONCRETE, ASPHALT OR PACKED EARTH MAY RESULT IN SERIOUS INJURY OR DEATH FROM FALLS.

1614-04-02
Alphabet Panel



1614-12-LP
School Bus Panel



1614-31-02
Stage Panel



1614-33-02
Audience Panel



1614-45-02
Gear Panel

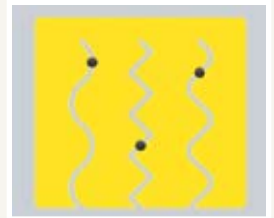

1614-88-06
Window Panel, Clear



1614-53
Storefront Countertop



1614-56-02
Maze Panel



1614-57-02
Maze Panel



1614-60-02
Clock Panel



1614-62
Paintable Panel, Clear

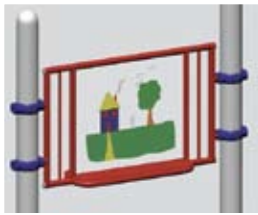

1614-66-02
Soccer Panel



1614-69-02
Baseball Panel



1614-85-02
USA Map Panel



More Graphic Panels:
Graphics appear on one side. Many additional panel graphics and custom designs are also offered. Contact us or your nearby Columbia Cascade representative.

1699-08
Tunnel Crawl, 'S' Curved

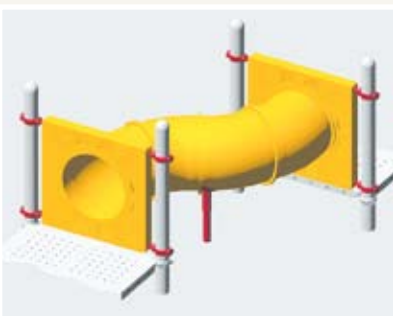

1699-01
Tunnel Crawl, Arched

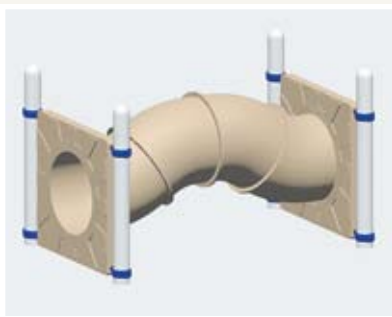

1699-90
Tunnel Crawl, Curved



1699-00
Tunnel Crawl

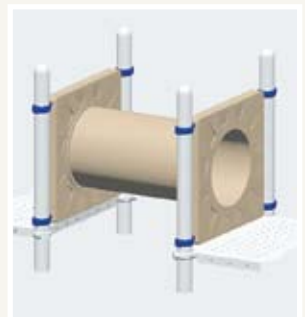

1699-20
Tunnel Crawl, Clear Plastic

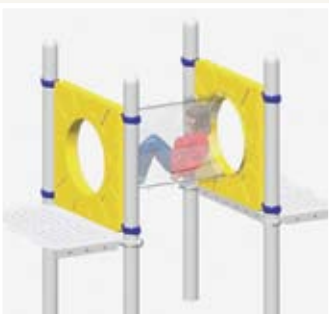

1698-00
Tunnel Crawl, Stainless Steel

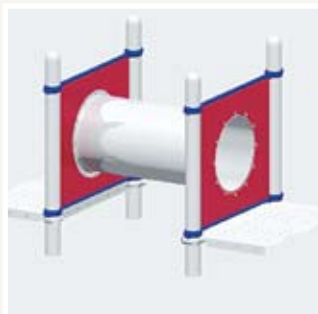

1611-00
Sand Table



1677-01
School Bus with Wheel and Timber Seats



U.S. Patent Des. 413,370

⚠ WARNING

METAL PLAYING SURFACES CAN BECOME DANGEROUSLY HOT WHEN EXPOSED TO DIRECT SUNLIGHT. OWNERS/OPERATORS MUST WARN USERS THAT SERIOUS THERMAL BURNS MAY RESULT WHEN BARE SKIN COMES IN CONTACT WITH HOT METAL.

Accessories

1694-01
Kid's Bench
Baluster Wall



1694-13
Kid's Bench
Woven Wire Wall



1694-4-91
Kid's Bench
(beneath deck)



1697-16-81
Accessible Transfer
Station, 8" (21cm) Riser

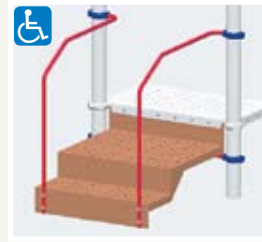

1697-18-60
Accessible Transfer
Station, 6" (15cm) Riser

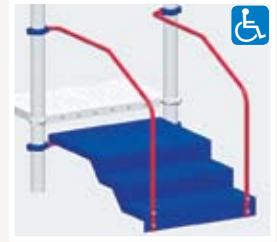

1648-4-91
Cargo Net



1675-4-11
Climbing Wall



1675-4-41
Climbing Ramp

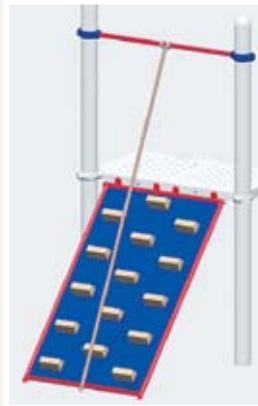

1675-6-71
Block Climber



1674-4-11
Arch Loop Climber

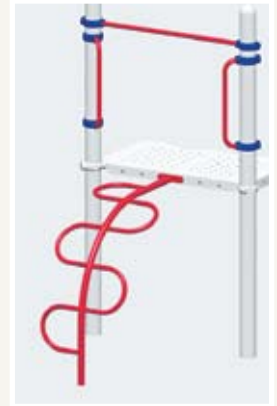

1674-4-21
Arch Ring Climber

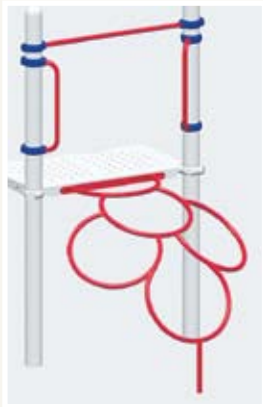

1674-4-91
Arch Climber



1674-4-93
Arch Climber
with Pipe Rails



1673-4-91
Arch Climber,
Timber Rungs



1633-4-01
Ribbon Slide

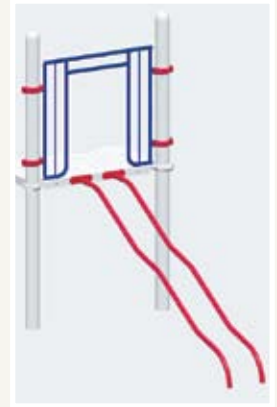

1683-3-91
Grade Climber
with Handrails



1684-2-91
Deck Climber
with Handrails

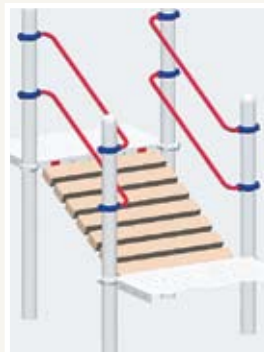

1696-30-60
Stairs with Handrails,
6" (15cm) Riser

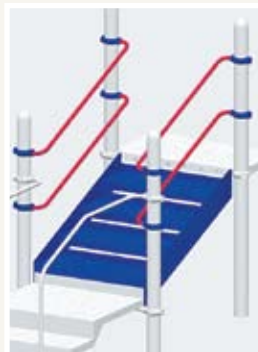

1696-32-81
Stairs with Handrails,
8" (21cm) Riser

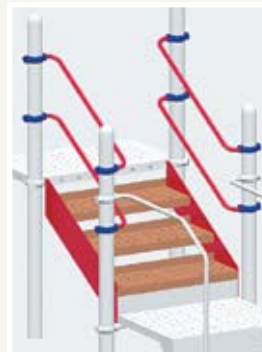

1686-67
Chinning Bar

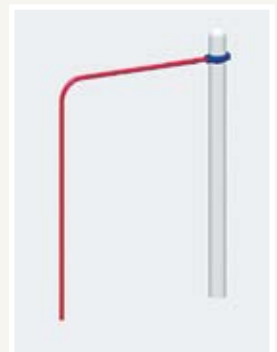

Accessories



WARNING

INSTALLATION OVER A HARD SURFACE SUCH AS CONCRETE, ASPHALT OR PACKED EARTH MAY RESULT IN SERIOUS INJURY OR DEATH FROM FALLS.

1634-4-01
Bannister Rails

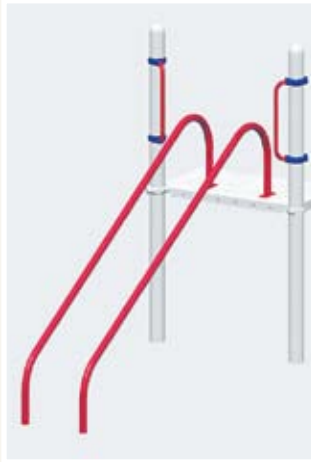

1681-4-11
Loop Climber

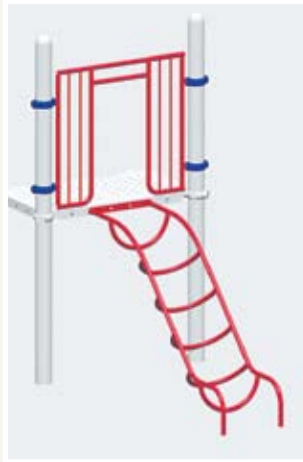

1681-4-21
Loop Climber
with Handrails

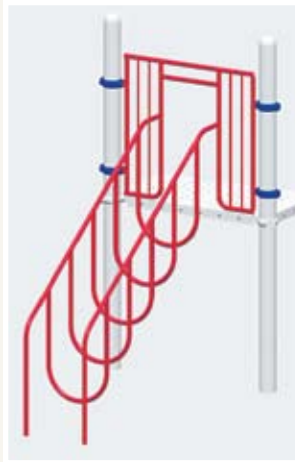

1687-4-11
Vertical Ladder



1687-4-91
Vertical Safety
Climber



1679-4-93
Coil Climber

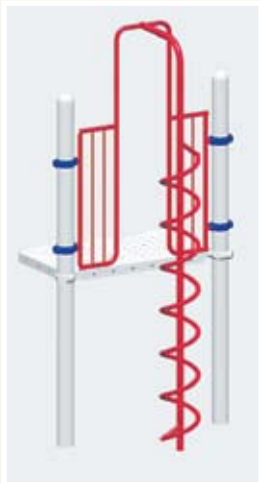

1629-4-93
Firefighter's Pole



1679-4-11
Vertical Loop
Climber

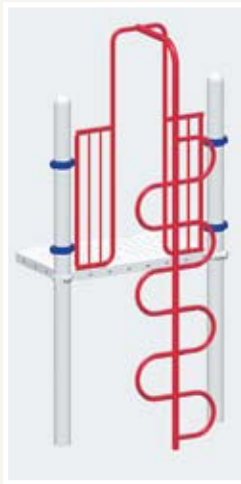

1674-4-31
Twisting Climber

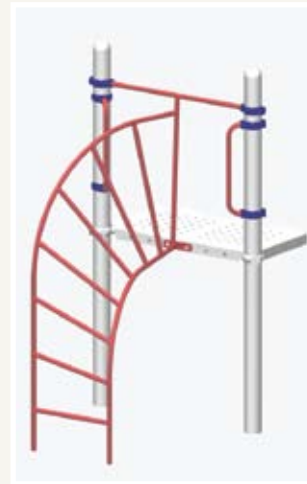

1681-5-41
Funnel Net Climber



1667-5-93
Spiral Stairway
with Handrail



1675-7-21
Totem Climber



1605-72
Talk Tube



1605-43-67
Talk Tube
(requires underground connection)



WARNING

METAL PLAYING SURFACES CAN BECOME DANGEROUSLY HOT WHEN EXPOSED TO DIRECT SUNLIGHT. OWNERS/OPERATORS MUST WARN USERS THAT SERIOUS THERMAL BURNS MAY RESULT WHEN BARE SKIN COMES IN CONTACT WITH HOT METAL.

Accessories

1648-8-11
Cargo Net Climber



1648-4-95
CrossClimber Cargo Net

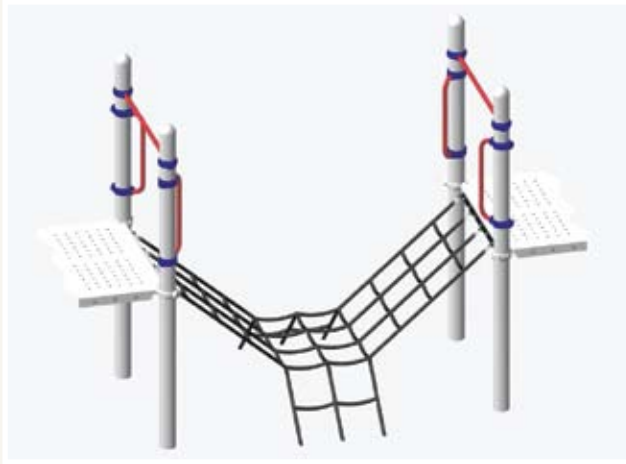

1648-4-14
Vertical Cargo Net



1621-11
Accessible Ring Pull



1692
Accessible Pull Ladder

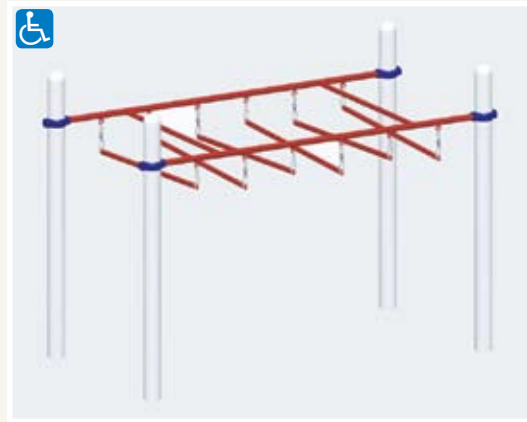

1665-8-11
Accessible Pull Slide

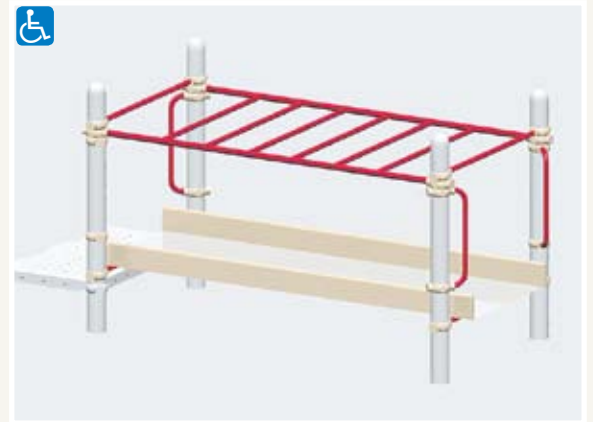

1690-11
Circular Overhead Ladder

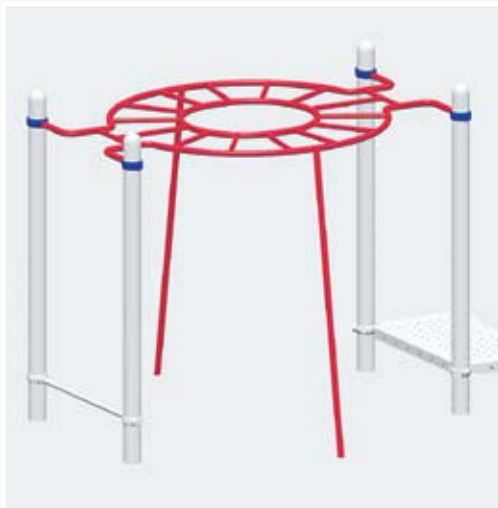

1690*
Curved Overhead Ladder

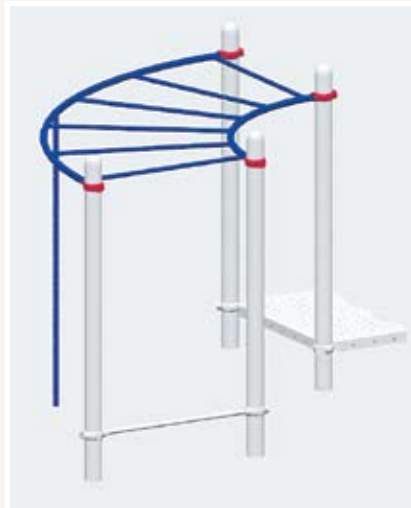

1624-8
Loop Ladder

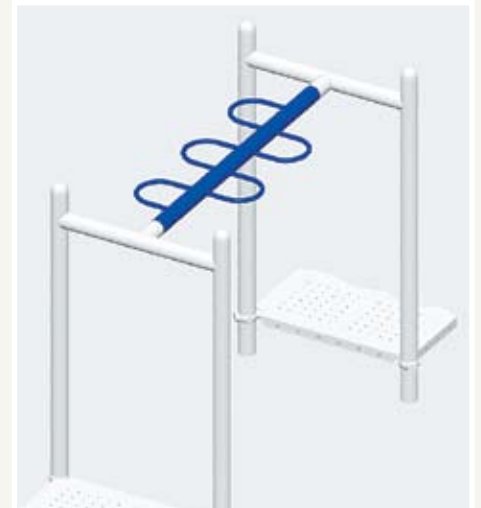

*The **1690 Curved Overhead Ladder** can be used in combination to create half, three-quarter, full circle or 'S' curved shapes.

Accessories



WARNING

INSTALLATION OVER A HARD SURFACE SUCH AS CONCRETE, ASPHALT OR PACKED EARTH MAY RESULT IN SERIOUS INJURY OR DEATH FROM FALLS.

1689
Overhead Safety Ladder

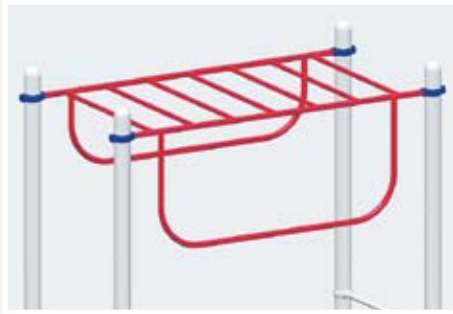

1691-8
Overhead Ladder

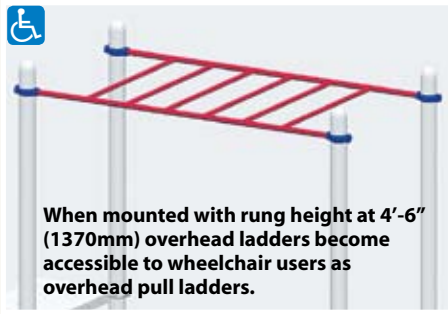

When mounted with rung height at 4'-6" (1370mm) overhead ladders become accessible to wheelchair users as overhead pull ladders.

1623-12
Ring Beam



1623-12-02
Double Ring Beam



1623-12-03
Super Ring Beam



1624-12-14
Wheel Beam



1622-12-11
Track Ride
(See page 93 for Track Ride Mechanism Detail)

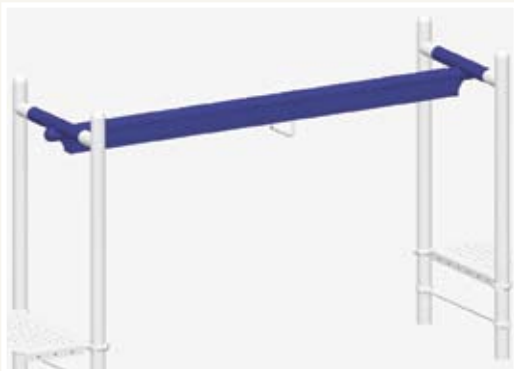

1662-12-97
Accessible Deck Ramp, Brown Plastic-coated Perforated Steel with Handrails

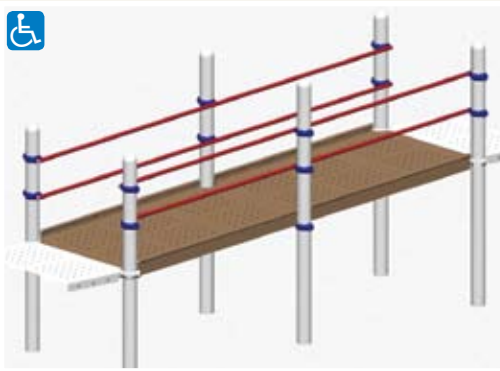

1662-6-90
Accessible Deck Ramp, Wood with Handrails



1661-12-90
Accessible Grade Ramp, Wood with Handrails

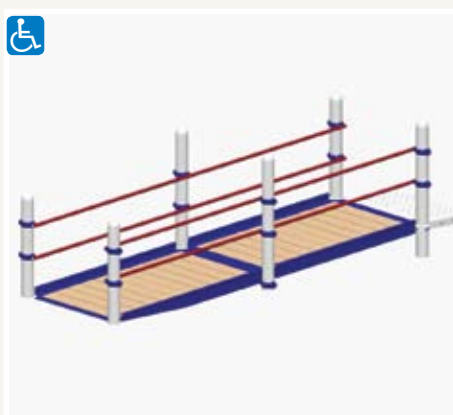

1664-8-00
Bridge, Wood with Handrails



1655-8-91
Moving Bridgeway with Handrails

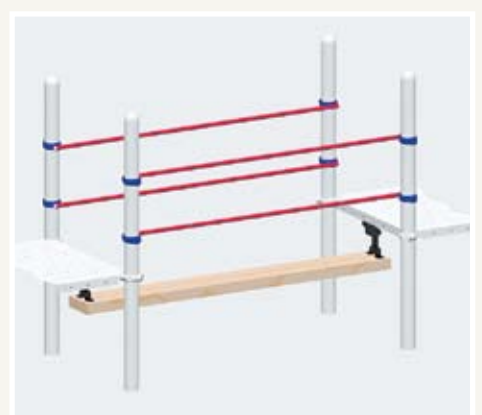

WARNING

METAL PLAYING SURFACES CAN BECOME DANGEROUSLY HOT WHEN EXPOSED TO DIRECT SUNLIGHT. OWNERS/OPERATORS MUST WARN USERS THAT SERIOUS THERMAL BURNS MAY RESULT WHEN BARE SKIN COMES IN CONTACT WITH HOT METAL.

Accessories

1664-8-36
Arched Bridge, Perforated Steel with Baluster Walls



1664-8-20
Arched Bridge, Wood with Handrails

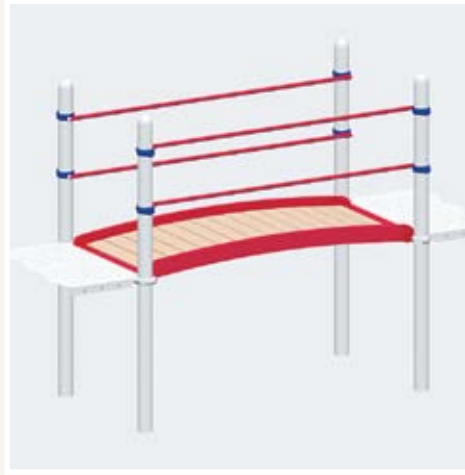

1656-8-83
Suspension Bridge, Steel with Handrails

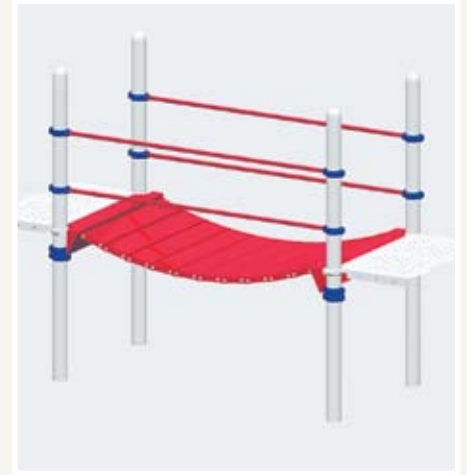

1656-8-84
Suspension Bridge, Steel with Baluster Walls

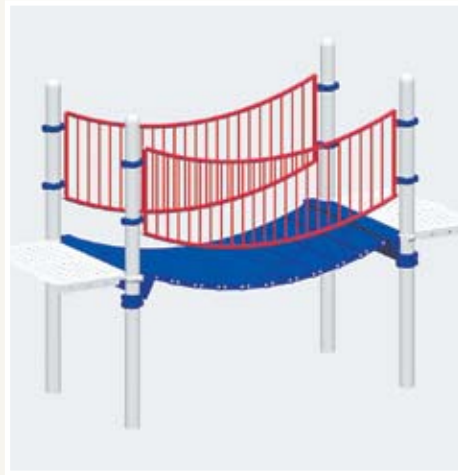

1656-8-91
Clatter Bridge, Wood with Handrails

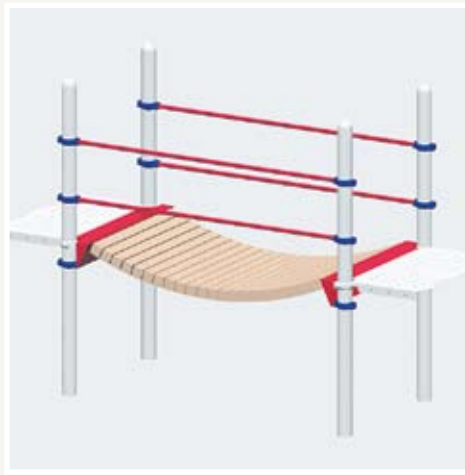

1656-8-92
Clatter Bridge, Wood with Baluster Walls



1656-8-93
Clatter Bridge, Steel with Handrails

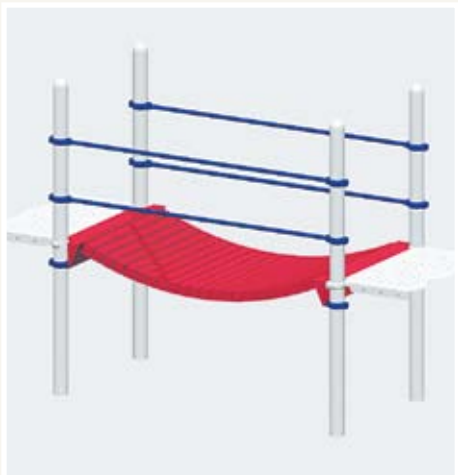

1656-8-94
Clatter Bridge, Steel with Baluster Walls



1664-90-57-PL
90° Curved Bridge, Brown Plastic-coated Perforated Steel with Baluster Walls



Need CAD details or specifications? Contact us at HQ@timberform.com

Accessories



WARNING

INSTALLATION OVER A HARD SURFACE SUCH AS CONCRETE, ASPHALT OR PACKED EARTH MAY RESULT IN SERIOUS INJURY OR DEATH FROM FALLS.

1636-4-00

Tube Chute, Stainless Steel,
23" (585mm) Diameter

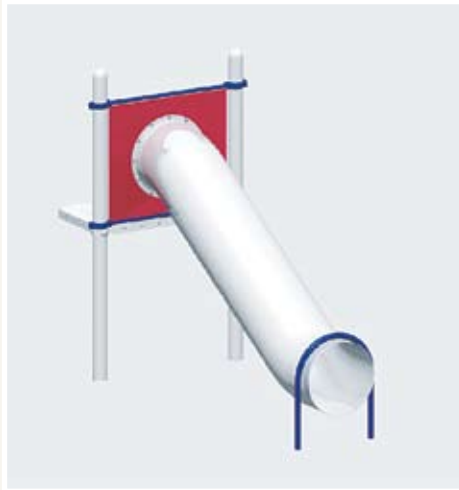

1636-4-100

Tube Chute, Stainless Steel,
23" (585mm) Diameter

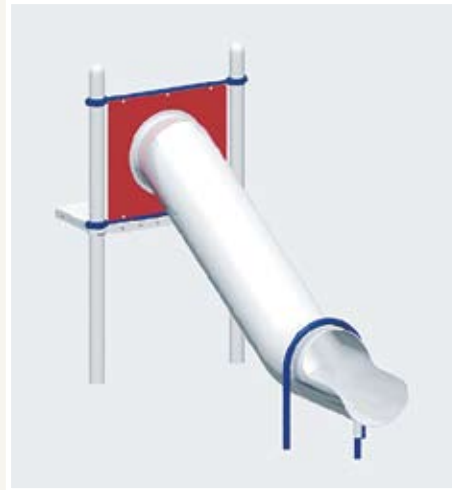

1636-4-200

Tube Chute, Stainless Steel,
30" (760mm) Diameter



1636-4-03

Tube Chute, Curved, Stainless Steel,
23" (585mm) Diameter

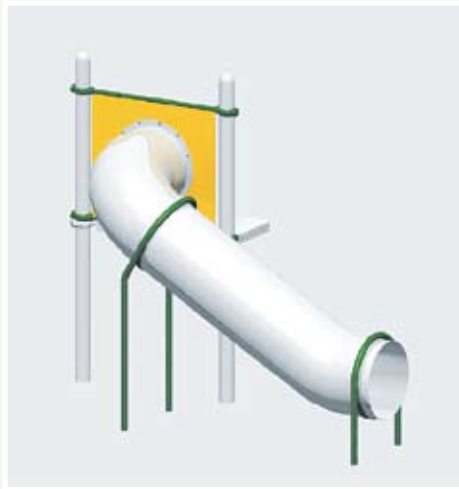

1636-4-16

Tube Chute, Curved, Stainless
Steel, 23" (585mm) Diameter

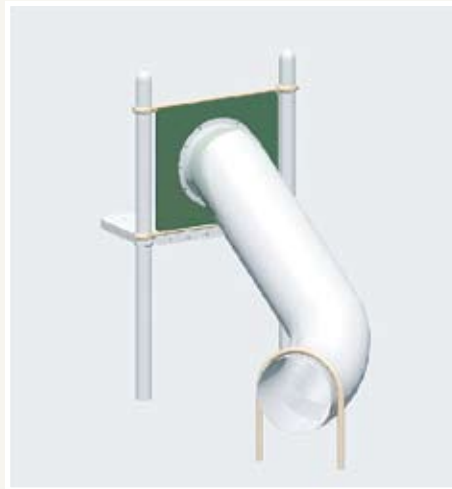

1636-4-26

Tube Chute, 'S' Curved, Stainless
Steel, 23" (585mm) Diameter



1636-4-203

Tube Chute, Curved, Stainless Steel,
30" (760mm) Diameter

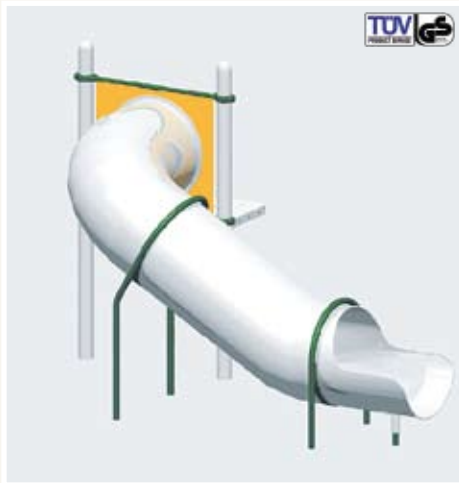

1636-4-116

Tube Chute, Curved, Stainless
Steel, 23" (585mm) Diameter

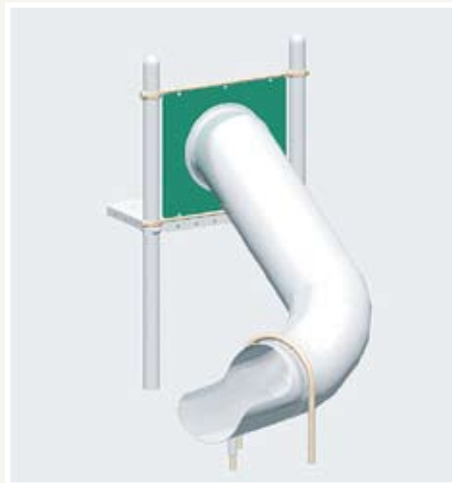

1636-4-226

Tube Chute, 'S' Curved, Stainless
Steel, 30" (760mm) Diameter



WARNING

METAL PLAYING SURFACES CAN BECOME DANGEROUSLY HOT WHEN EXPOSED TO DIRECT SUNLIGHT. OWNERS/OPERATORS MUST WARN USERS THAT SERIOUS THERMAL BURNS MAY RESULT WHEN BARE SKIN COMES IN CONTACT WITH HOT METAL.

Accessories

1640-4-51
Slide Chute, Stainless Steel

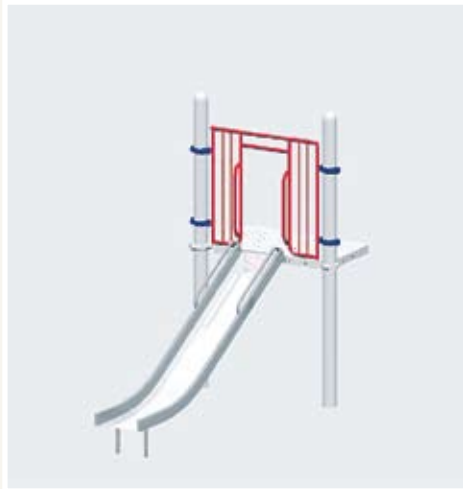

1641-6-51
Wave Chute, Stainless Steel

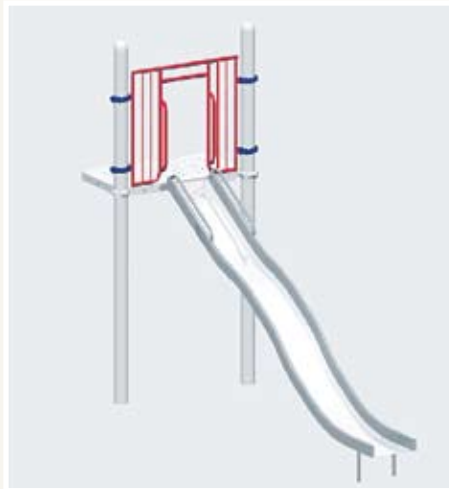

1643-4-51
Wide Chute, Stainless Steel

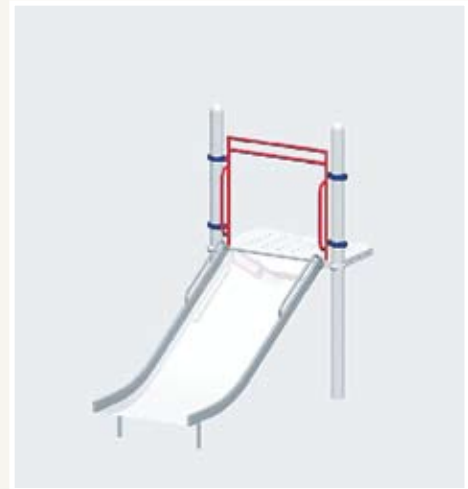

1643-4-53
Wide Chute with Center Rail, Stainless Steel

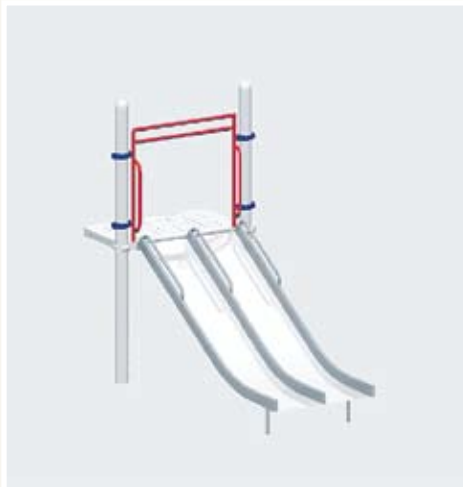

1644-6-51
Wide Wave Chute, Stainless Steel

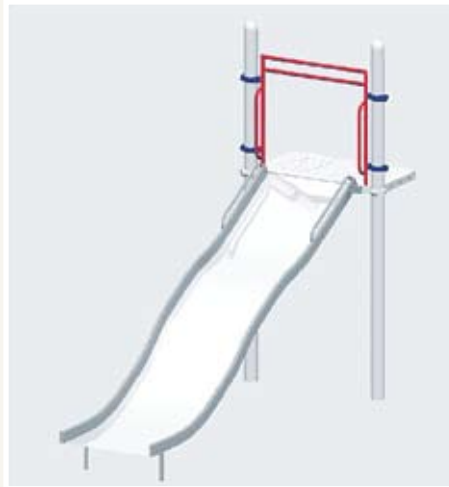

1644-6-53
Wide Wave Chute with Center Rail, Stainless Steel

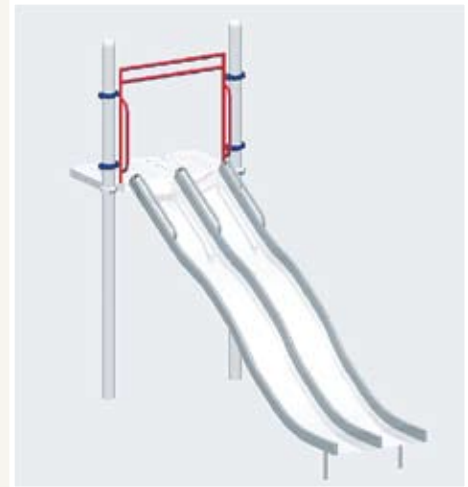

1640-4-54
Slide Chute, Stainless Steel with 6" (15cm) Rails



1641-6-54
Wave Chute, Stainless Steel with 6" (15cm) Rails



1643-4-54
Wide Chute, Stainless Steel with 6" (15cm) Rails



TÜV, an independent testing agency, have inspected our engineering data, factory, materials and quality control systems and products *in situ*.

Accessories

WARNING INSTALLATION OVER A HARD SURFACE SUCH AS CONCRETE, ASPHALT OR PACKED EARTH MAY RESULT IN SERIOUS INJURY OR DEATH FROM FALLS.

1643-4-55
Wide Chute with Center Rail,
Stainless Steel with 6" (15cm) Rails



1644-6-54
Wide Wave Chute, Stainless Steel
with 6" (15cm) Rails



1644-6-55
Wide Wave Chute with Center Rail,
Stainless Steel with 6" (15cm) Rails



1646-5-31
Spiral Slide Chute,
Stainless Steel



1646-6-31
Spiral Slide Chute,
Stainless Steel



1646-6.7-31
Spiral Slide Chute,
Stainless Steel



1646-2.5-31
Tot Spiral Slide Chute,
Stainless Steel



1646-2.5-41
Tot Spiral Slide Chute,
Stainless Steel



1647-5-31
Spiral Slide Chute



WARNING

METAL PLAYING SURFACES CAN BECOME DANGEROUSLY HOT WHEN EXPOSED TO DIRECT SUNLIGHT. OWNERS/OPERATORS MUST WARN USERS THAT SERIOUS THERMAL BURNS MAY RESULT WHEN BARE SKIN COMES IN CONTACT WITH HOT METAL.

Accessories

1647-6-31
Spiral Slide Chute



1647-7-31
Spiral Slide Chute



1650-3-51
Slide Chute



1650-4-51
Slide Chute

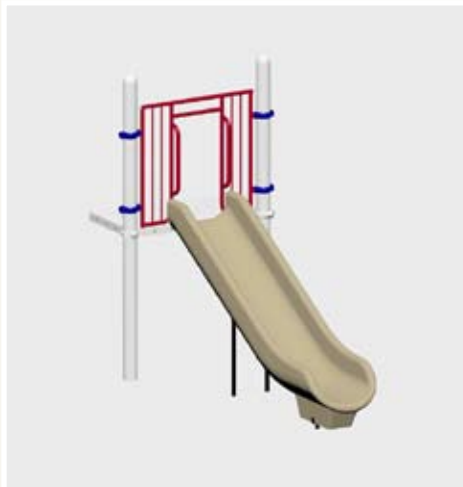

1650-5-51
Slide Chute

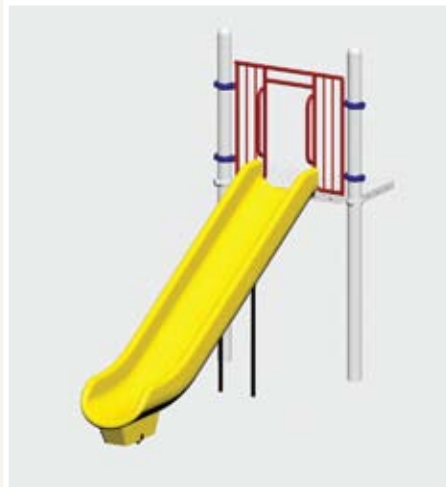

1650-3.5-52
Slide Chute, Curved (Right 42 degrees)

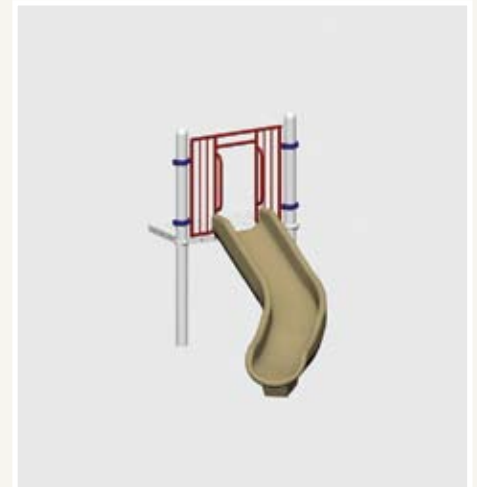

1650-4-53
Slide Chute, Curved
(Left 63 degrees)

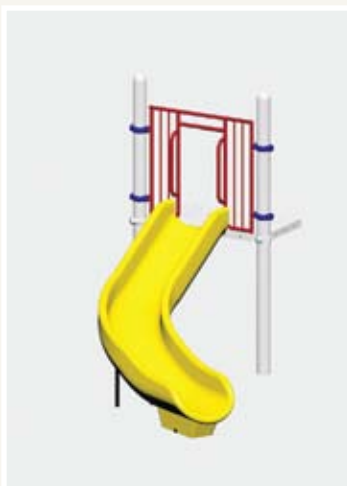

1650-4.5-52
Slide Chute, Curved
(Right 34 degrees)

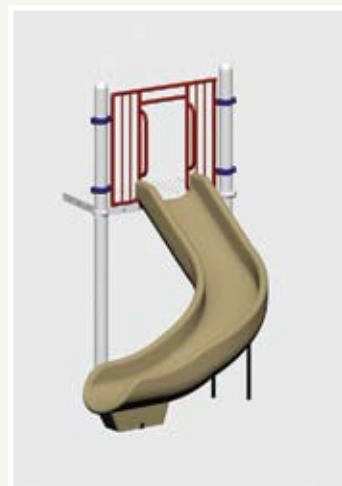

1650-5-53
Slide Chute, Curved
(Left 105 degrees)

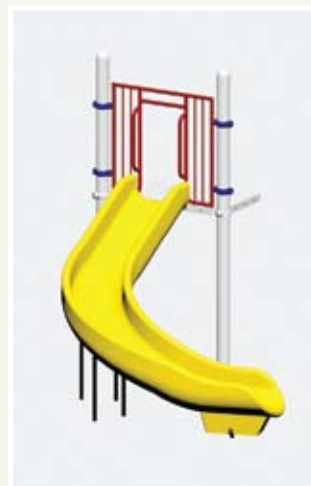

1650-5.5-52
Slide Chute, Curved
(Right 126 degrees)

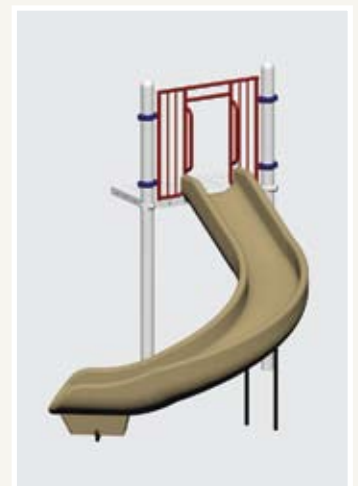

Engineers from TÜV, an internationally recognized independent testing agency headquartered in Germany, have inspected our engineering data, factory, materials and quality control systems and products *in situ*. For more information on TÜV see page 95.

Accessories



WARNING

INSTALLATION OVER A HARD SURFACE SUCH AS CONCRETE, ASPHALT OR PACKED EARTH MAY RESULT IN SERIOUS INJURY OR DEATH FROM FALLS.

1650-6-53
Slide Chute, Curved
(Left 147 degrees)



1651-5-51
Wave Chute

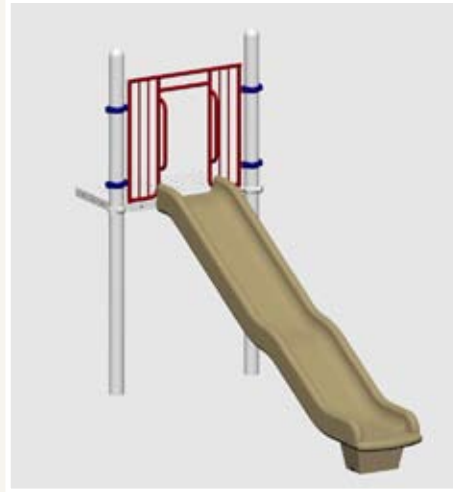

1652-3-51
Tot Slide Chute, Curved

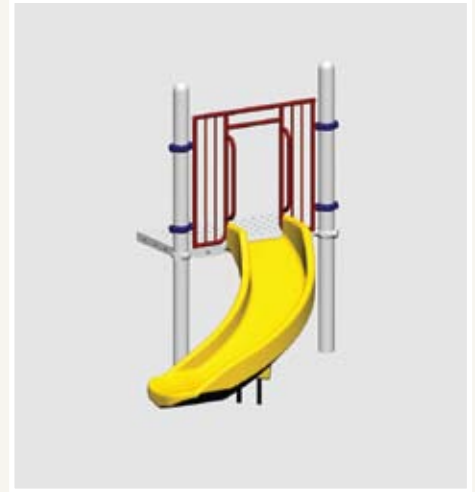

1654-4-51
Wide Slide Chute, Wave/Slalom

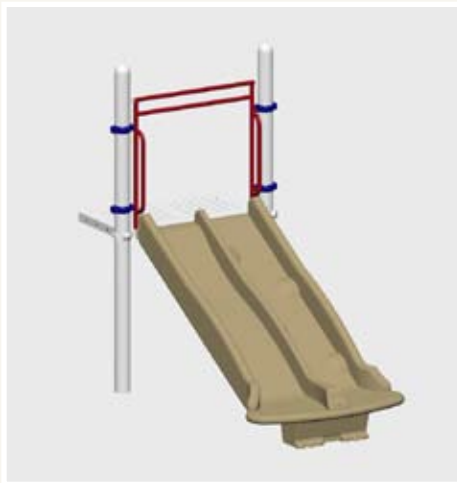

1638-4-51
Wide Chute



1637-4-00
Tube Chute



1637-4-02
Tube Chute, Curved

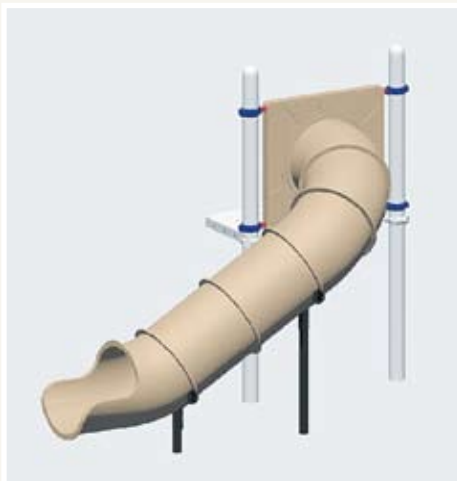

1637-4-17
Tube Chute, Curved

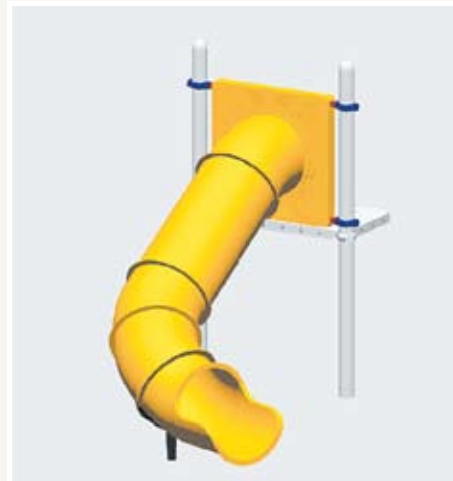

1637-4-27
Tube Chute, 'S' Curved

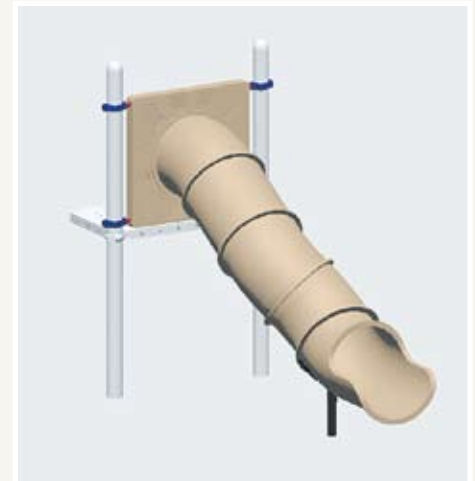

Need CAD details or specifications? Contact us at HQ@timberform.com

WARNING

METAL PLAYING SURFACES CAN BECOME DANGEROUSLY HOT WHEN EXPOSED TO DIRECT SUNLIGHT. OWNERS/OPERATORS MUST WARN USERS THAT SERIOUS THERMAL BURNS MAY RESULT WHEN BARE SKIN COMES IN CONTACT WITH HOT METAL.

Accessories

1608-10
Wood Roof



1608-11
Wood Roof with Pennant



1608-14
Perforated Steel Roof

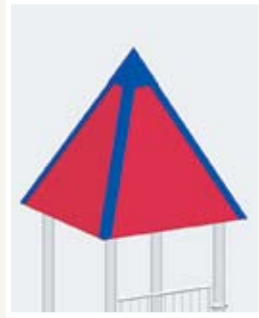

1608-02
Roof



1608-01
Decorative Gable



1608-01-TF
TimberForm
Decorative Gable



1608-00
Decorative Arch



1608-00-TF
TimberForm
Decorative Arch



1608-80
Cathedral Arch



1608-03-01
TimberForm
Single Shed Roof



1608-06-01
TimberForm
Single Gable Roof



1608-40
Quad Wood Roof



1608-44
Quad Perforated Steel Roof



1608-60
Hex Wood Roof



1608-64
Hex Perforated Steel Roof



1608-117-TF
Gable Trellis Roof with End Panels

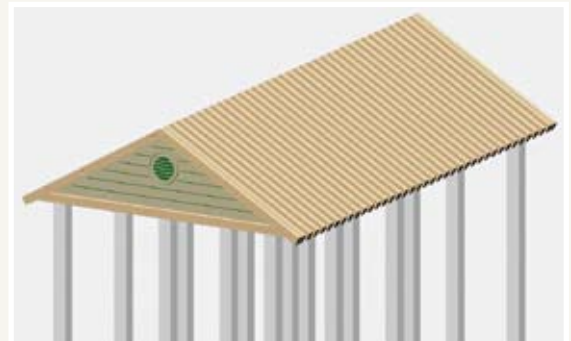

Accessories



WARNING

INSTALLATION OVER A HARD SURFACE SUCH AS CONCRETE, ASPHALT OR PACKED EARTH MAY RESULT IN SERIOUS INJURY OR DEATH FROM FALLS.

PipeLine Half Deck



- 91-10-01** Wood
- 91-10-21** Recycled Plastic 
- 91-10-61** Perforated Steel
- 91-10-71** SofDek Plastic-coated Perforated Steel

PipeLine Single Deck



- 91-10-02** Wood
- 91-10-22** Recycled Plastic 
- 91-10-62** Perforated Steel
- 91-10-72** SofDek Plastic-coated Perforated Steel

PipeLine Corner Deck



- 91-10-03** Wood
- 91-10-23** Recycled Plastic 
- 91-10-63** Perforated Steel
- 91-10-73** SofDek Plastic-coated Perforated Steel

PipeLine Triangle Deck

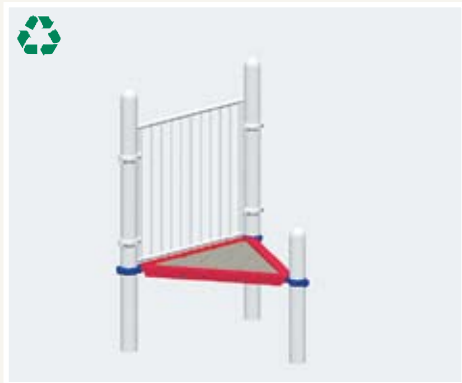

- 91-10-04** Wood
- 91-10-24** Recycled Plastic 
- 91-10-64** Perforated Steel
- 91-10-74** SofDek Plastic-coated Perforated Steel

PipeLine Half Hex Deck



- 91-10-05** Wood
- 91-10-25** Recycled Plastic 
- 91-10-65** Perforated Steel
- 91-10-75** SofDek Plastic-coated Perforated Steel

PipeLine Single Wide Deck



- 91-10-06** Wood
- 91-10-26** Recycled Plastic 
- 91-10-66** Perforated Steel
- 91-10-76** SofDek Plastic-coated Perforated Steel

PipeLine Double Deck



- 91-10-09** Wood
- 91-10-29** Recycled Plastic 
- 91-10-69** Perforated Steel
- 91-10-79** SofDek Plastic-coated Perforated Steel

PipeLine Quad Deck



- (4)91-10-02** Wood
- (4)91-10-22** Recycled Plastic 
- (4)91-10-62** Perforated Steel
- (4)91-10-72** SofDek Plastic-coated Perforated Steel

PipeLine Hex Deck



- (2)91-10-05** Wood
- (2)91-10-25** Recycled Plastic 
- (2)91-10-65** Perforated Steel
- (2)91-10-75** SofDek Plastic-coated Perforated Steel



WARNING METAL PLAYING SURFACES CAN BECOME DANGEROUSLY HOT WHEN EXPOSED TO DIRECT SUNLIGHT. OWNERS/OPERATORS MUST WARN USERS THAT SERIOUS THERMAL BURNS MAY RESULT WHEN BARE SKIN COMES IN CONTACT WITH HOT METAL.

Accessories

TimberForm/RePlay Half Deck



4400-0.5-02 SofDek Plastic-coated Perforated Steel

4400-0.5-04 Recycled Plastic

TimberForm/RePlay Single Deck



4400-1-02 SofDek Plastic-coated Perforated Steel

4400-1-04 Recycled Plastic

TimberForm/RePlay Corner Deck



4400-3-02 SofDek Plastic-coated Perforated Steel

4400-3-04 Recycled Plastic

TimberForm/RePlay Double Deck

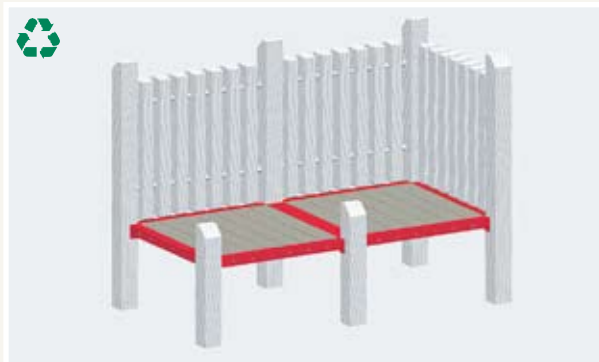

(2)4400-1-02 SofDek Plastic-coated Perforated Steel

(2)4400-1-04 Recycled Plastic

TimberForm/RePlay Quad Deck



4400-4-02 SofDek Plastic-coated Perforated Steel

4400-4-04 Recycled Plastic

1000-01
Welcome/Rules Sign,
Ages 2 to 5



1000-01 and 1000-02
Welcome/Rules Sign
(Reverse Side)



1000-02
Welcome/Rules Sign,
Ages 5 to 12



Welcome/Rules sign panel background color conforms to ANSI Standard Z535.1 "Safety Blue".

(Sep.) = Separates
(Acc.) = Accessories
(Thm.) = Themed

A

- Abacus (Acc.) 99
- Accessible,**
- Balance Beam (Sep.) 94
- Overhead Ladder (Acc.) 94
- Pull Ladder (Sep.) 94
 (Acc.) 103
- Pull Slide (Acc.) 103
- Ramps (Acc.) 104
- Ring Pull (Sep.) 103
 (Acc.) 103
- Spring Rider (Sep.) 87
- Swings (Sep.) 90
- Transfer Station (Acc.) 101
- Airplane (Thm.) 18
- Arch Climber (Sep.) 92
 (Acc.) 101
- Arch Loop Climber (Sep.) 92
 (Acc.) 101
- Arch Net Climber (Sep.) 92
- Arch Ring Climber (Acc.) 101
- Arched Bridge (Acc.) 105

B

- Balance Beam (Sep.) 94
- Baluster Wall (Acc.) 99
- Bannister Rails (Acc.) 102
- Barn (Thm.) 22 & 23
- Belt Seat Replacement 88
- Bench, Kid's (Acc.) 101
- Benches
 See Site Furnishing Catalog
- Bicycle Racks
 See CycLoops & CycLocker Catalog
- Block Climber (Acc.) 101
- Bridges (Acc.) 104

C

- Cargo Net (Acc.) 101
- Cargo Net Climber (Acc.) 103
 Also see Net Climber 92
- Chime Wall (Acc.) 99
- Chinning Bar (Sep.) 94
 (Acc.) 101
- Circular Overhead Ladder
 (Acc.) 103
- Clatter Bridge (Acc.) 105
- Climbing Ramp (Acc.) 101
- Climbing Wall (Acc.) 101
- Coil Climber (Acc.) 102
- Corner Handle (Acc.) 99
- CrossClimber Cargo Net
 (Acc.) 103
- Curved Balance Beam
 (Sep.) 94

- Curved Bridge (Acc.) 105
- Curved Overhead Ladder
 (Sep.) 93 & 94
 (Acc.) 103

D

- Deck Climber (Acc.) 101
- Deck Ramp (Acc.) 104

Decks,

- Perforated Steel Decks
 (Acc.) 112
- PipeLine (Acc.) 112
- Plastic-coated (Acc.) .. 112 & 113
- Recycled Plastic Decks
 (Acc.) 112 & 113
- RePlay (Acc.) 113
- TimberForm (Acc.) 113
- Wood Decks (Acc.) 112

- Decorative Wall (Acc.) 99
- Double Arch Climber (Sep.) 92
- Double Arch Net Climber
 (Sep.) 92
- Double Ring Beam (Acc.) 104

E

- Embankment Slide Chutes
 (Sep.) 96

F

- Firefighter's Pole (Acc.) 102
- Fireman's Pole 102
- Funnel Net Climber (Acc.) 102

G

- Grade Climber (Acc.) 101
- Grade Ramp (Acc.) 104
- Graphic Panels 100
- Guard Rail (Acc.) 99

H

- Helicopter (Thm.) 18
- Hillside Slide 96

J

- Jungle-gym 94 & 104
 Also see Outdoor Fitness Catalog

K

- Kid's Bench (Acc.) 101
- KidSpinner (Sep.) 91

L

- Log Roll (Sep.) 93
- Lookout Platform (Acc.) 99
- Loop Climber (Acc.) 102
- Loop Ladder (Acc.) 103

M

- Mazes,**
- Panel (Acc.) 100
- Play Area (Thm.) 22

- Monkey Bars 94 & 104
 Also see Outdoor Fitness Catalog
- Moving Bridgeway (Acc.) 104

N

- Net Climber, Arched (Sep.) 92
 Also see Cargo Nets ... 101 & 103

O

- Overhead Arch Ladder
 (Sep.) 92 & 93
- Overhead Ladder (Sep.) 94
 (Acc.) 104
- Overhead Safety Ladder
 (Sep.) 94
 (Acc.) 104

P

Panels,

- Addition Panel (Acc.) 99
- Alphabet Panel (Acc.) 100
- Audience Panel (Acc.) 100
- Baseball Panel (Acc.) 100
- Bubble Panel (Acc.) 99
- Clock Panel (Acc.) 100
- Gear Panel (Acc.) 100
- Maze Panel (Acc.) 100
- Mirror Panel (Acc.) 99
- Paintable Panel (Acc.) 100
- Panel with Hole (Acc.) 99
- School Bus Panel (Acc.) 100
- Soccer Panel (Acc.) 100
- Spelling Panel (Acc.) 99
- Stage Panel (Acc.) 100
- USA Map Panel (Acc.) 100
- Window Panel (Acc.) 100
- Parallel Bars (Sep.) 94

- Picnic Tables
 See Site Furnishing Catalog
- Pivot-Pad Bridge (Sep.) 90
- Playground Rules Sign 113
- Powder-Coating Colors,
 19, 35 & 39
- Pull Ladder (Sep.) 94
 (Acc.) 103
- Pull Slide (Acc.) 103

R

- Ribbon Slide (Acc.) 101
- Ring Beam (Sep.) 93
 (Acc.) 104
- Roofs (Acc.) 111
- Rope Climber 101

S

- Sand Box (See Sand Table below)
- Sand Table (Acc.) 100
- School Bus with Wheel
 (Acc.) 100

- Seat, see Kid's Bench (Acc.) 101
 Also see Site Furniture Catalog

- Seat Spinner (Sep.) 91
- See-Saws (Sep.) 87
 (Thm.) 15 & 21
- Ships (Thm.) 14 - 17

Slides,

- Embankment Slide (Sep.) 96
- Slide Chute (Sep.) 95
 (Acc.) 107, 109 & 110
- Spiral Slide Chute (Sep.) 95
 (Acc.) 108 & 109
- Tot Slide Chute (Acc.) 110
- Tot Spiral Slide Chute
 (Acc.) 108
- Tube Chute (Sep.) 95
 (Acc.) 106 & 110
- Wave Chute (Sep.) 95
 (Acc.) 107 & 110
- Wave/Slalom Chute
 (Acc.) 110
- Wide Chute (Sep.) 95
 (Acc.) 107, 108 & 110
- Wide Wave Chute (Acc.)
 107 & 108
- With Center Rail (Sep.) 95
 (Acc.) 107 & 108

- Sloped Spinner (Sep.) 91
- Speed Ladder
 See Overhead Ladder .. 94 & 104

- Spiral Spinner (Sep.) 91
- Spiral Stairway (Acc.) 102
- Spinners 91
- SpringPad (Sep.) 92
- Spring Riders (Sep.) 87
- Spring Rider See-Saws (Sep.) ... 87
 (Thm.) 15 & 21

- Stairs with Handrails (Acc.) 101
- Stepping Pads (Sep.) 91
- Storefront Countertop (Acc.) ... 100
- Super Ring Beam (Acc.) 104
 (Thm.) 15 & 21
- Suspension Bridge (Acc.) 105
- Swing Seat Replacement 88

Swings,

- Accessible Swings (Sep.) 90
- Double Belt / Tot Swing
 (Sep.) 88 & 89
- Double Belt Swing (Sep.) 88
- Gullwing Swing (Sep.) 89
- TyreSwing (Sep.) 88 & 89
- Swing Sets (Sep.) 88 - 90

T

- Talk Tube (Acc.) 102
- Tandem Spring Rider See-Saw
 (Sep.) 87
- Teeter-totter (See See-Saws) ... 87

Themed Play,

- Aviation Theme 18
- Castle Theme 25
- Cattle Ranch 24 & 87
- Conestoga Wagon 21
- Emergency Vehicles 20 & 21
- Farm Theme 22, 23, 25 & 87
- Fire Truck 20 & 21
- Helicopter 18
- Lighthouse 17
- Maze 22
- Nautical Theme 14 - 17 & 87
- Patrol Car 21
- Pirate Ship 15
- Rail Cars 20, 26 & 87
- Railroad Theme 20, 26 & 87
- Ranch Theme 24 & 87
- Rocket Ship 19
- Ships 14 - 17 & 87
- Tractors 23 & 25
- Train 20, 26 & 87
- Trolley Car 26
- Western Theme 21, 24 & 87

- Tic-Tac-Toe (Acc.) 99
- Tot Seat Replacement 88
- Totem Tower Climber (Acc.) 102
- Track Ride (Sep.) 93
 (Acc.) 104
- Track Ride Detail (Sep.) 93
- Trains (Thm.) 20 & 26
- Transfer Station (Acc.) 101
- Trapeze Rings
 See Ring Beam 93 & 104
- Triple Arch Climber (Sep.) 92
- Tunnel Crawls (Sep.) 91
 (Acc.) 100
- Twisting Climber (Acc.) 102
- TyreSwing
 Replacement Apparatus 88

V

- Vertical Cargo Net (Acc.) 103
- Vertical Ladder (Acc.) 102
- Vertical Loop Climber (Acc.) 102
- Vertical Safety Climber (Acc.) .. 102

W

- Walls (Acc.) 99 & 101
- Welcome/Rules Sign 113
- Welded Wire Wall (Acc.) 99
- Wheel Beam (Acc.) 104
- WhirlAround (Sep.) 91
- White Water Raft (Sep.) 92
- Wood Wall (Acc.) 99

Z

- Zip-line (See Track Ride) ... 93 & 104



TimberForm® RePlay® The Eco-friendly Playground



Publication No. PC-2009



Makers of TimberForm® & PipeLine® Playground Equipment and Outdoor Fitness Systems, TimberForm Site Furniture and CycLoops® & CycLocker® Bicycle Management Products.

www.timberform.com



Moodie
Outdoor Products

www.moodie.com.au
sales@moodie.com.au
1300 666 343