

SEITE 00

TM

2018 - 19

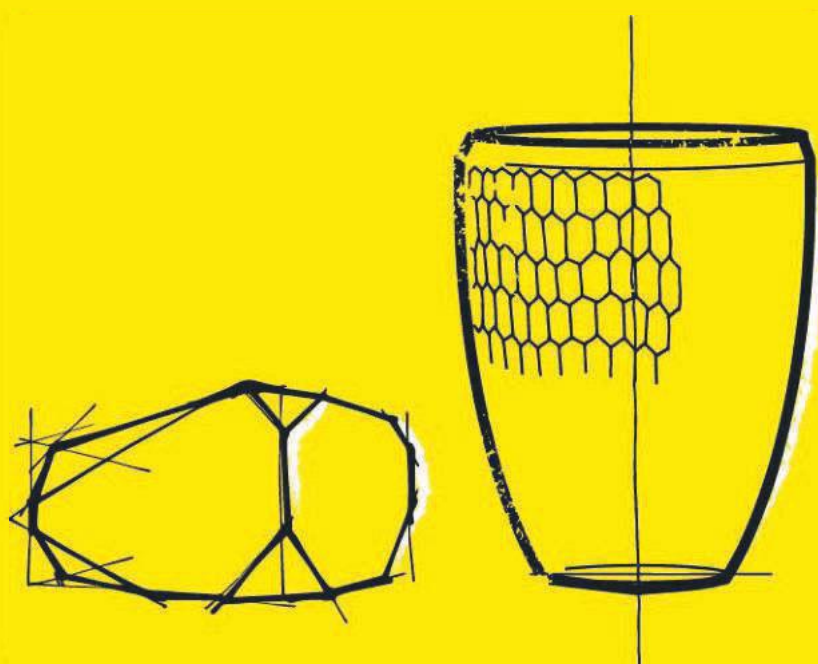

SERENE
CALM
CLEAR
STILL
QUIET
BEAUTY
HARMONY
EMOTIONS

sereno™

MOULDED WITH LOVE · MOULDED WITH LOVE · MOULDED WITH LOVE





ABOUT US

Italian for serene, calm, clear, still & quiet. In addition to these qualities are function, beauty, harmony & emotions - This is the philosophy behind our brand.

Products of everyday use, enriching lifestyles, removing boundaries between indoors and outdoors, objects that we feel one with. Sereno's eye-catching designs whether a sculptural planter or seating are conceived to be highly functional as well as beautiful, and attest to our mastery of new synthetic polymers and moulding processes. Significantly, these high quality weather-resistant designs enable a natural and almost seamless visual progression from indoor to outdoor spaces, thereby considerably extending living environments. Sereno products are functional and aesthetic, innovative and practical with a clean design philosophy.

Through its product line, Sereno offers myriad ways of experiencing nature & light. Ways, which ask us to stop for a bit, relax, sit, breathe & enjoy the moment.

Each Sereno product radiates light, and coupled with a wide array of colours and finishes, these indoor and outdoor pots become one with nature and its architectural surroundings.

AWARDS



YUVRAJ SINGH AHUJA

An architect by qualification and a moulder by profession, Yuvraj started SERENO - a product line of indoor & outdoor lifestyle products complementing nature in 2009.

A strong believer in everlasting design and its function, he enjoys taking the product through its complete life cycle - from conceptualisation to its final execution.



THE TEAM

SATISH GOKHALE

A prolific industrial designer and an alumnus of the National Institute of Design (NID) and with over 35 years of experience, Satish has an innovative approach to converging materials and form together with function.

He was awarded the Best Indian Designer by BusinessWorld and NID, and has won many accolades both in India and abroad. Satish is on the advisory boards of several reputed design schools, and also part of the India Design Council.



FIORIERE
(Full Body Planters)

- Piatto - SW 14
- Linea - SW 22
- Elena - SW 28
- Eloisa - SW 34
- Orabella -SW 38



SEGGIO
(Seating)

- Piero 84
- Enea 92
- Cara 96
- Ilaria 100

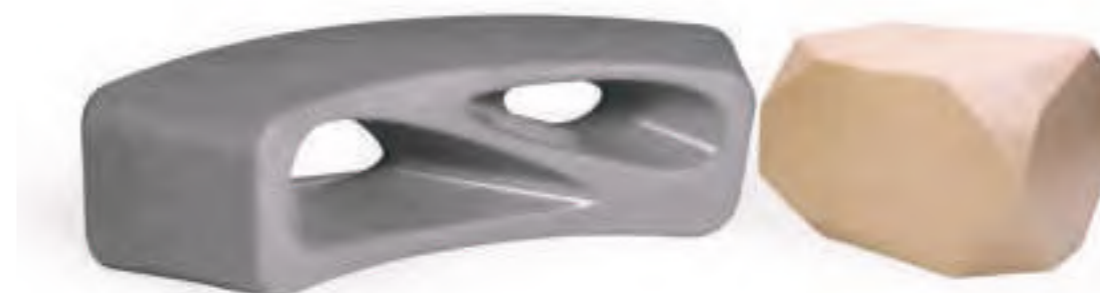

FIORIERE - 2
(Half Body Planters)

- Chiara 46
- Piatto 58
- Elena 64
- Eloisa 68
- Orabella 72
- Gioia 76



LUME
(Lamps)

- Triangolo 106
- Ovale 106
- Esagono 106
- Seme 116



01



FIORIERE
(Full Body Planters)



100%
RECYCLABLE



NON-FADING
COLORS



EASY TO
CLEAN



UV
STABLE



ANTI
FROST



MOULDED
WITH LOVE



SUPER
LIGHT



RUST
PROOF



SUPER LIGHT WEIGHT

Sereno planters are lightweight yet sturdy enough to take the weight of soil and large plants. Special 100% recyclable polymers are hand-picked from world over to manufacture these planters. One piece seamless product, no joints, no peeling, no fading & homogenous construction makes Sereno the ideal home for your plants.



Piatto 7560 SW Sicilian Grey

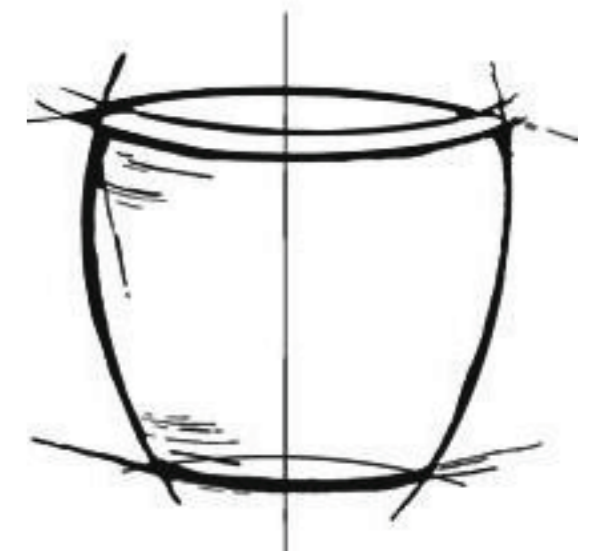

PIATTO SW





Piatto 7835 SW Dholpur Beige



Piatto 7560 SW Dholpur Beige



PIATTO (Pi-aa-toh)

These versatile planters have been inspired from the shape of a dish or a bowl, using hand textures, like carved stone bowls and a simple, unobtrusive flow that already has a classic design sensibility to it. These planters are deep enough to hold large plants and flower groupings. The scattered line texture creates the illusion of beautiful stone planters of ancient times.





Piatto 10460 SW Panther Black



Piatto 7560 SW Milano Grey



Piatto 4835 SW Dholpur Beige

POTTING INSTRUCTION

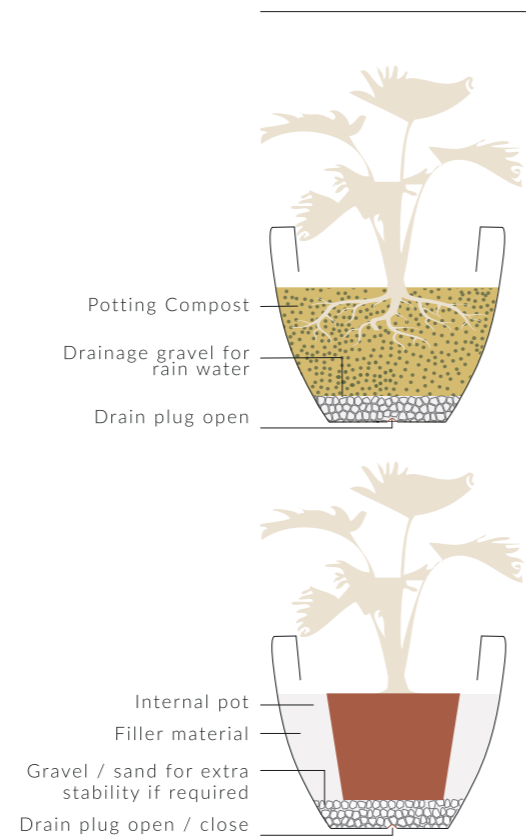

SIZES*

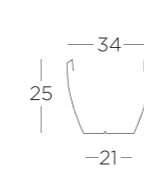

PIATTO 3425 SW
22 Lts

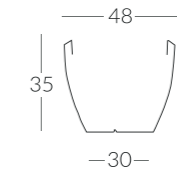

PIATTO 4835 SW
38 Lts

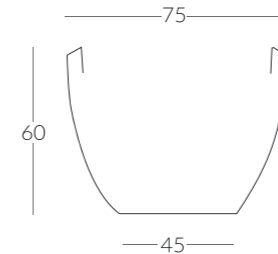

PIATTO 7560 SW
180 Lts

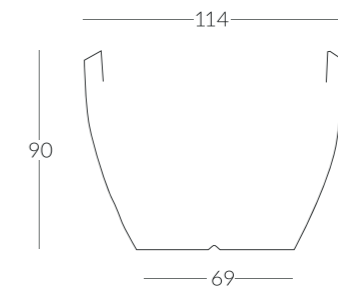

PIATTO 11490 SW
650 Lts

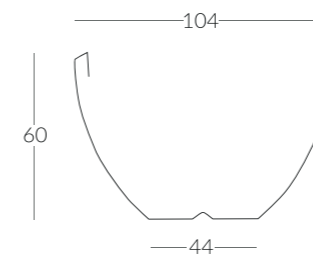

PIATTO 10460 SW
315 Lts

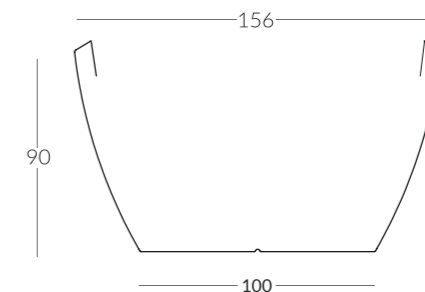

PIATTO 15690 SW
1230 Lts



AVAILABLE IN

GRANITE FINISH

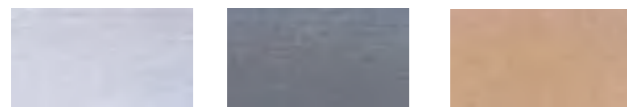

Milano Grey Sicilian Grey Baltic Brown



Dholpur Beige Exotic white Lava Black

SOLID FINISH



Sherwood Brown Polar White Panther Black



Fire Red Flame Yellow Irish Green

*MORE COLOUR OPTIONS ARE AVAILABLE ON REQUEST

Vol: xxx Lts.

*ALL DIMENSIONS IN CENTIMETRES



Linea 12090 SW, Linea 9060 SW, Linea 9040 SW. All Sicilian Grey



LINEA SW



Linea 12090 SW Sicilian Grey



Linea 12090 SW, Linea 9060 SW. All Milano Grey



LINEA (Lee-nee-ah)

This rectangular long, narrow plant pots can create environments and segment others, like a green divider. A modern twist to a rectangle with curve edges, these three-dimensional planters are versatile and blend easily in most surroundings. Use them in a row or in a combination of different heights to create your unique space.

POTTING INSTRUCTION

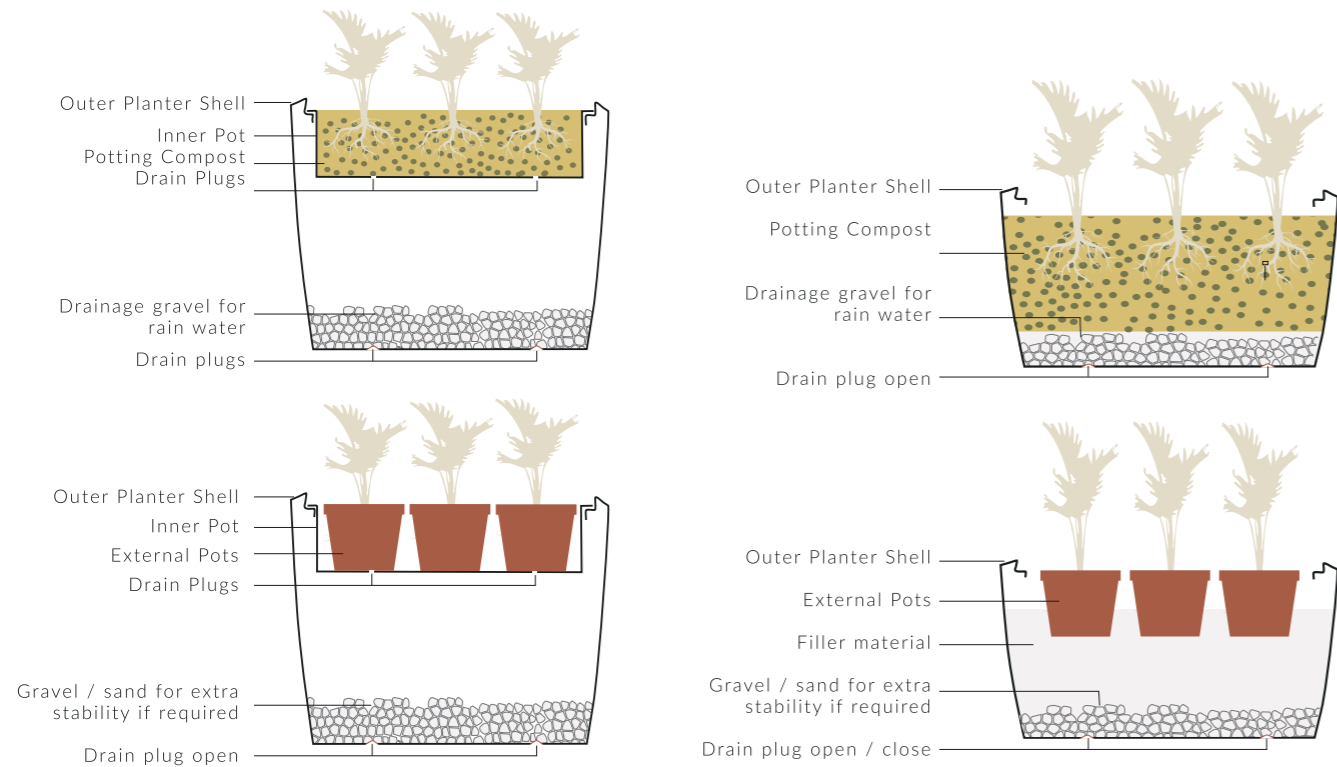

SIZES *

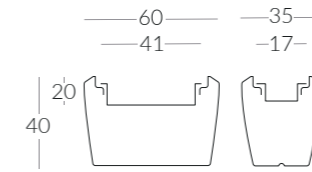

LINEA 6040 SW
55 Lts
Tray 10 Lts

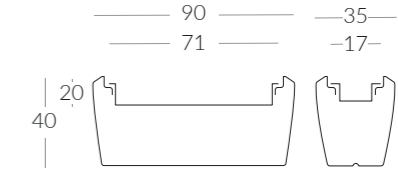

LINEA 9040 SW
85 Lts
Tray 19 Lts

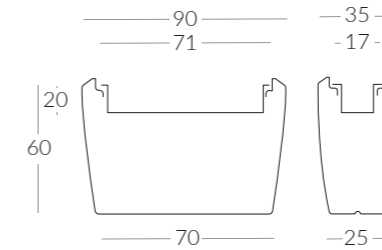

LINEA 9060 SW
140 Lts
Tray 19 Lts

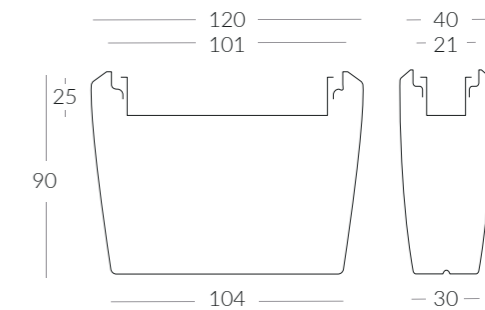

LINEA 12090 SW
340 Lts
Tray 42 Lts

AVAILABLE IN

GRANITE FINISH

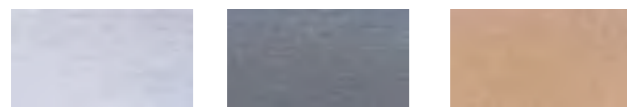

Milano Grey Sicilian Grey Baltic Brown



Dholpur Beige Exotic white Lava Black

SOLID FINISH



Sherwood Brown Polar White Panther Black



Fire Red Flame Yellow Irish Green

*MORE COLOUR OPTIONS ARE AVAILABLE ON REQUEST



Our Linea planters come with a detachable tray making it one of our most versatile creations.

Vol: xxx Lts.

*ALL DIMENSIONS IN CENTIMETRES



Elena 90 SW Sicilian Grey



ELENA SW



Elena 90 SW Baltic Brown



Elena 60 SW Milano Grey



ELENA (ae-lee-na)

These planters have been inspired by the ancient from the ancient Greek word Helena, which means 'torch'. With its simple lines, height, and a narrow base, the Elena planter is economical with space yet impressive, chic, and sophisticated.



Elena 90 SW Baltic Brown

POTTING INSTRUCTION

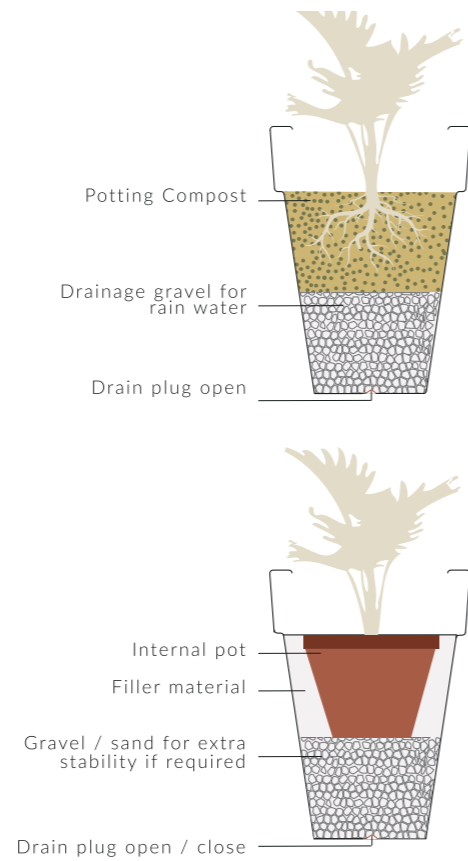

SIZES*

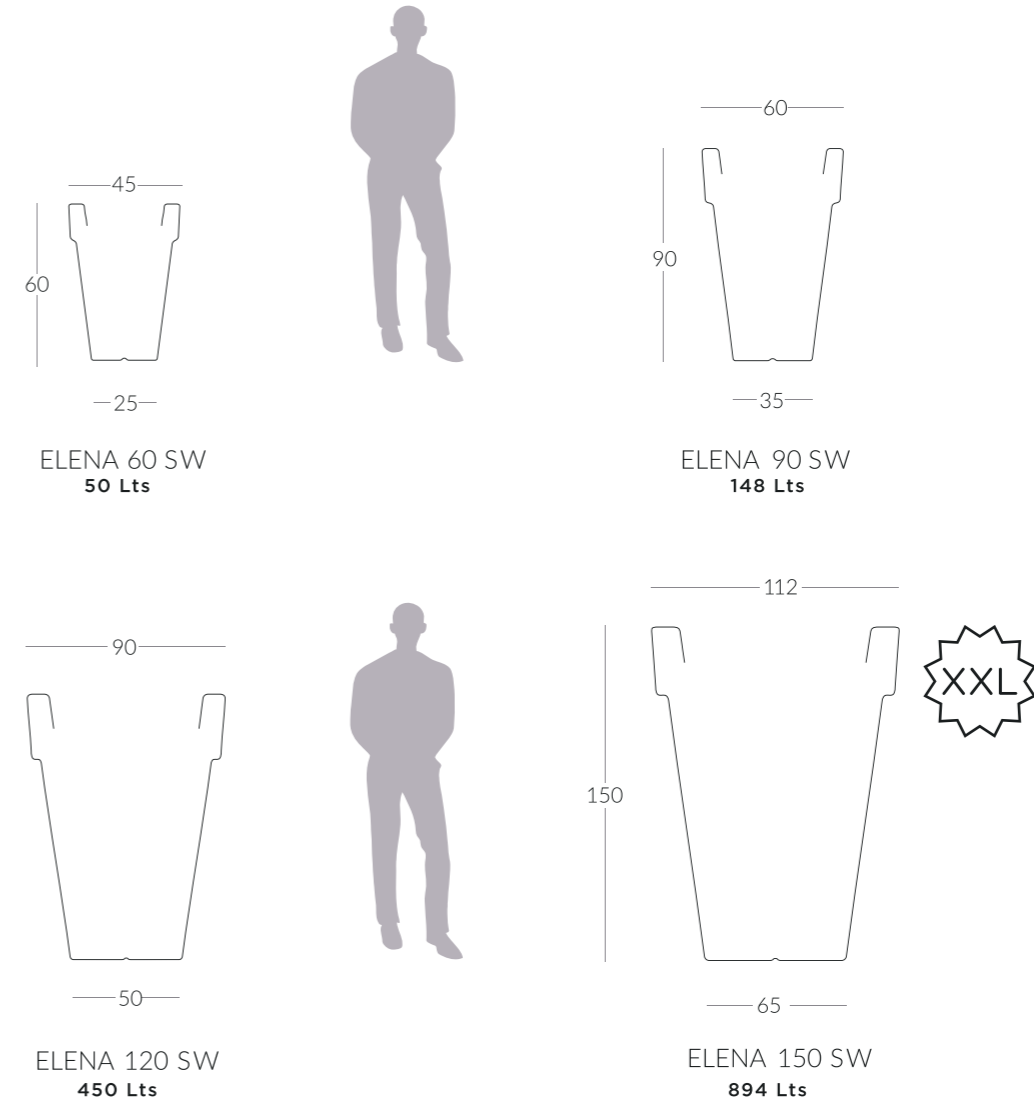

AVAILABLE IN

GRANITE FINISH

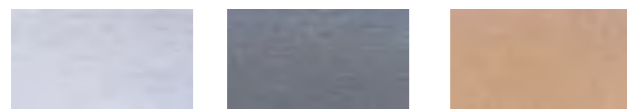

Milano Grey Sicilian Grey Baltic Brown

SOLID FINISH



Sherwood Brown Polar White Panther Black



Dholpur Beige Exotic white Lava Black



Fire Red Flame Yellow Irish Green

*MORE COLOUR OPTIONS ARE AVAILABLE ON REQUEST

Vol: xxx Lts.

*ALL DIMENSIONS IN CENTIMETRES





Eloisa 60 SW Sicilian Grey



ELOISA SW



Eloisa 90 SW Panther Black



ELOISA (ae-loi-sa)

A similar design language to the Elena but with a much wider base. With its large presence, these planters are perfect for big lawns, entrance porch or places where you want to show grandeur. Eloisa is deep and strong enough to hold large plants that might catch wind due to their foliage.

POTTING INSTRUCTION

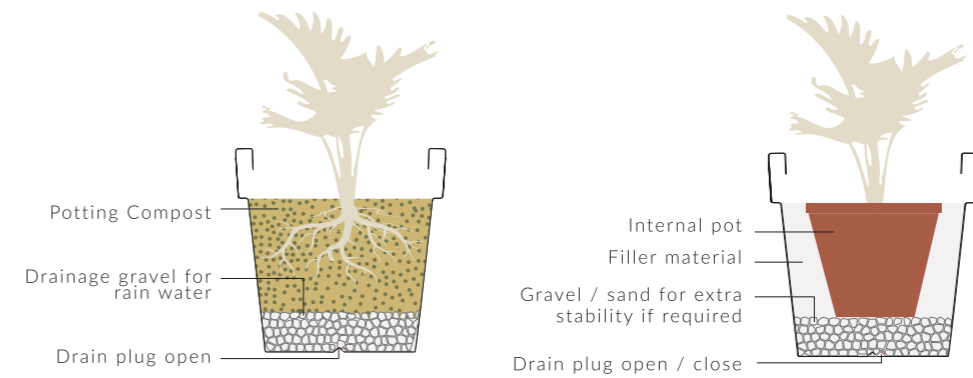

AVAILABLE IN

GRANITE FINISH



Milano Grey

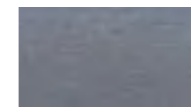

Sicilian Grey



Baltic Brown



Dholpur Beige



Exotic white



Lava Black

SOLID FINISH



Sherwood Brown



Polar White



Panther Black



Fire Red



Flame Yellow



Irish Green

SIZES*

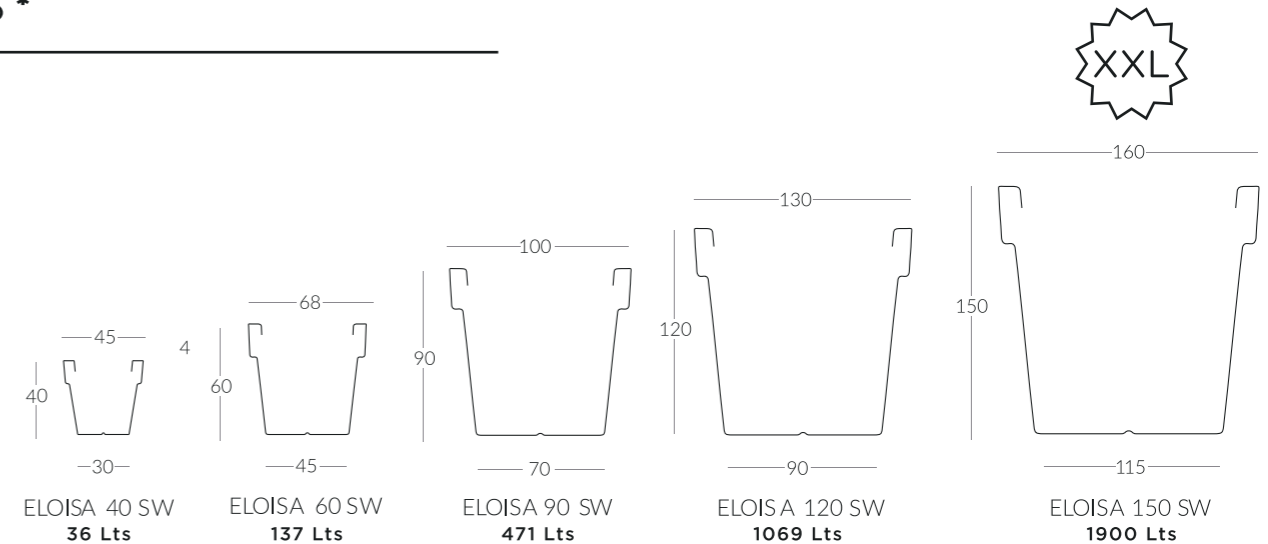

Vol: xxx Lts.

*MORE COLOUR OPTIONS ARE AVAILABLE ON REQUEST

*ALL DIMENSIONS IN CENTIMETRES 37



Orabella 60 SW Baltic Brown

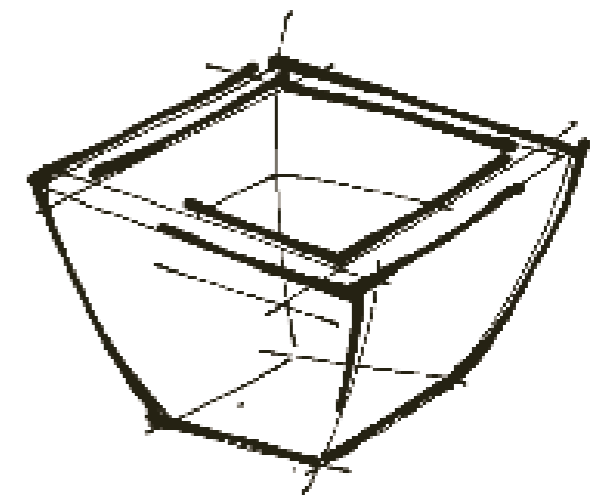

ORABELLA SW



Orabella 45 SW Sicilian Grey

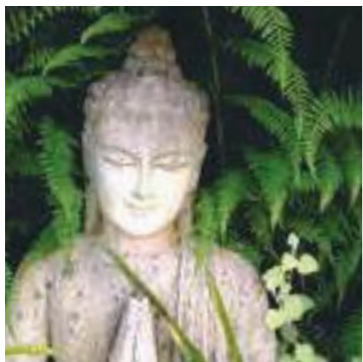

ORABELLA (o-ra-bella)

A pure geometric form that blends perfectly into modern spaces. Use Orabella in open spaces or corridors.

These planters offer great planting and visual experience. The internal cavity is deep enough for plants up to 5 feet tall.

Available in three sizes these planters are great for indoors as well as outdoors.

POTTING INSTRUCTION

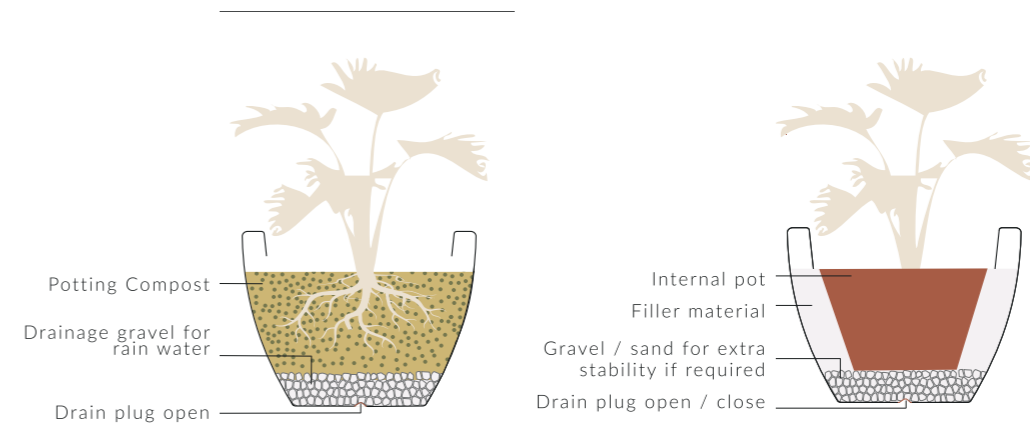

AVAILABLE IN

GRANITE FINISH



Milano Grey

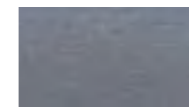

Sicilian Grey



Baltic Brown



Dholpur Beige



Exotic white



Lava Black

SOLID FINISH



Sherwood Brown



Polar White



Panther Black



Fire Red



Flame Yellow



Irish Green

SIZES*

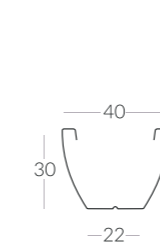

ORABELLA 30 SW
31 Lts

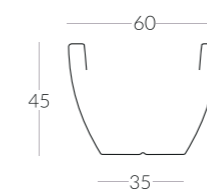

ORABELLA 45 SW
113 Lts

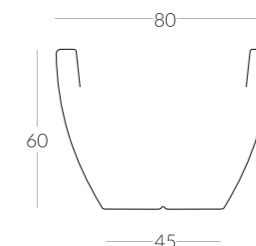

ORABELLA 60 SW
274 Lts



Vol: xxx Lts.

*MORE COLOUR OPTIONS ARE AVAILABLE ON REQUEST

*ALL DIMENSIONS IN CENTIMETRES 41

02

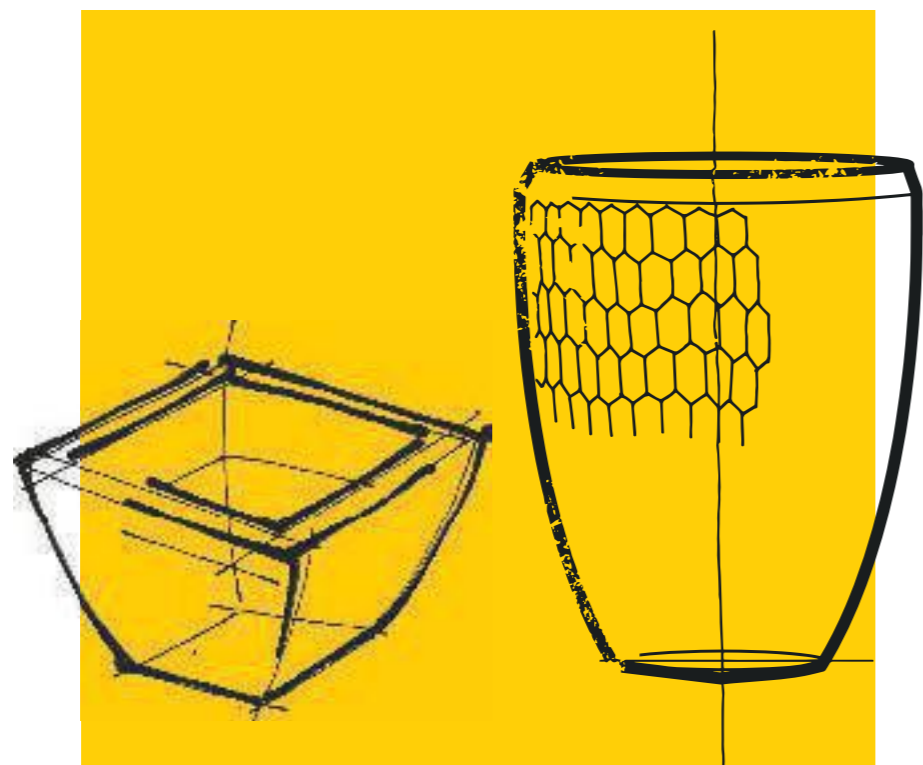

FIORIERE - 2

(Half Body / LED Planters)



100%
RECYCLABLE



NON-FADING
COLORS



EASY TO
CLEAN



UV
STABLE



ANTI
FROST



MOULDED
WITH LOVE



LED
VARIANT



RUST
PROOF



UP TO 85% LESS ENERGY

Our entire product range uses only LED lighting. Why? Because LED is the most energy-efficient lighting there is. It uses significantly less energy compared to conventional or CFL bulbs and lasts much longer.

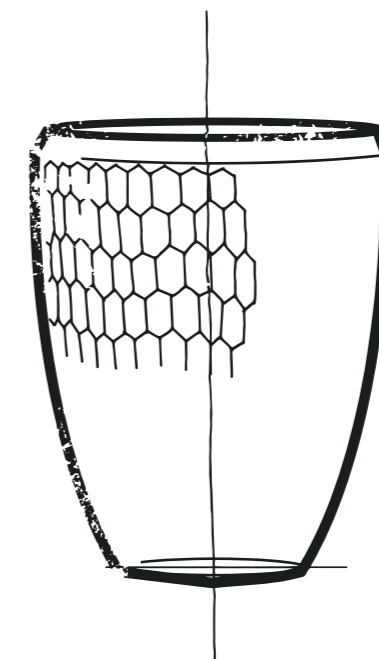
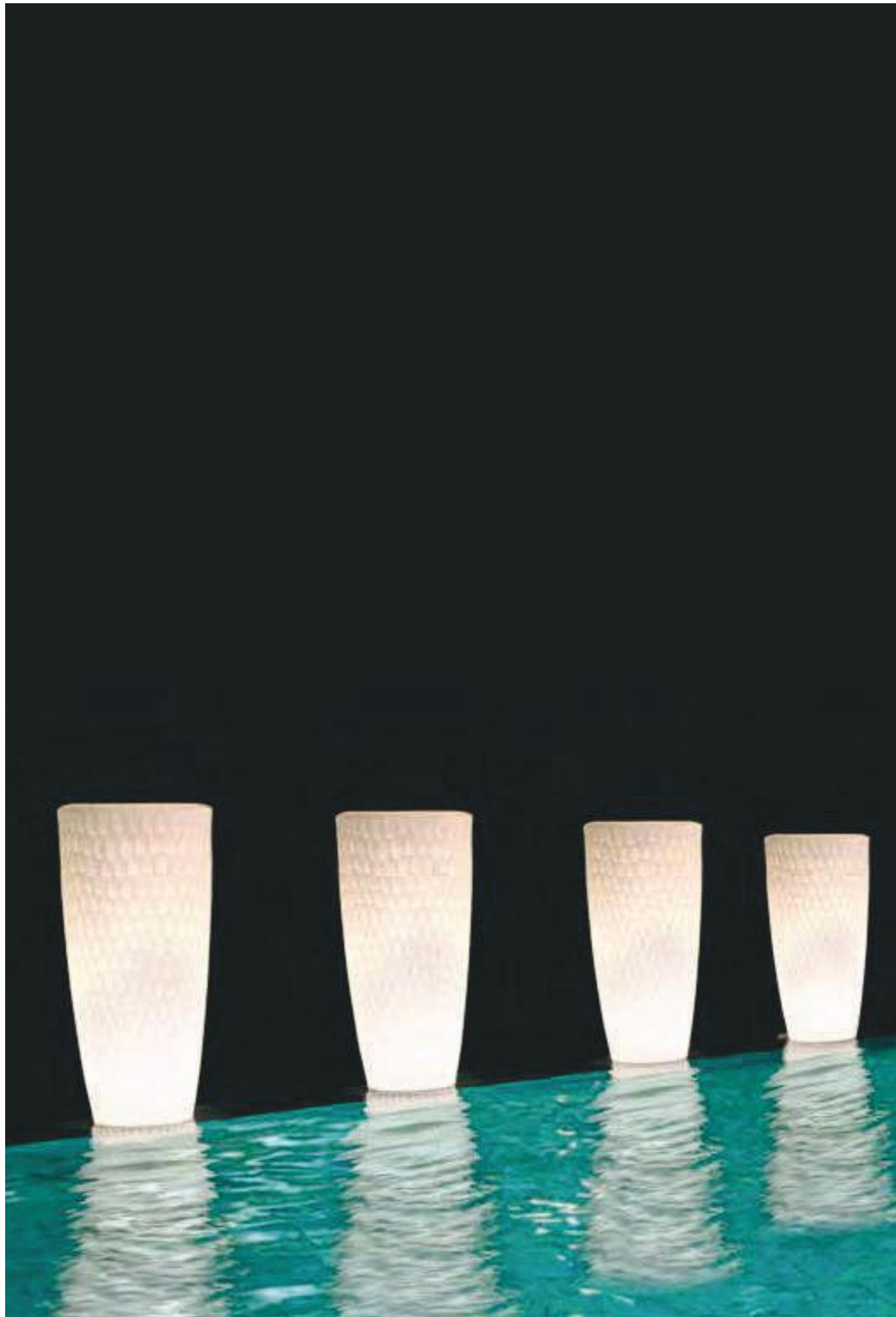

CHIARA



Chiara Slim 100 Polar White



Left to Right: Chiara Slim 100 Panther Black, Chiara 60 Panther Black



CHIARA

(key-aa-ra)

Means 'clear' in Italian.

The design philosophy behind this product is unlike any other with its elegance and charm. The Chiara planter gives the sense of slowly being hand carved out from a solid rock while it stands tall. It is breathtaking when illuminated with the light emphasising the planter's every detail. These half body planters have won several national and international awards.



Chiara Slim 100 Baltic Brown



Chiara Slim 100 Baltic Brown



Left to Right: Chiara 120 Translucent White with LED, Chiara 90 Translucent White with LED



Our LED planters are known for their smart innovation, advanced technology, remarkable energy efficiency, and high durability.



Chiara Slim 100
Translucent White



Chiara Slim 100
Exotic White



Chiara Slim 100
Baltic Brown



Chiara Slim 100 Translucent
white with LED

Chiara Slim 100
Exotic White with LED

Chiara Slim 100
Baltic Brown with LED



Left to Right: Chiara Slim 140 Gold Lacquer, Chiara Slim 100 Gold Lacquer

CHIARA METALLICS



Copper



Silver



Gold

Our Metallic Lacquer finishes can be used for indoor and outdoor purposes. The products are further coated with PU to enhance the life of the lacquer.



POTTING INSTRUCTION

HALF BODY

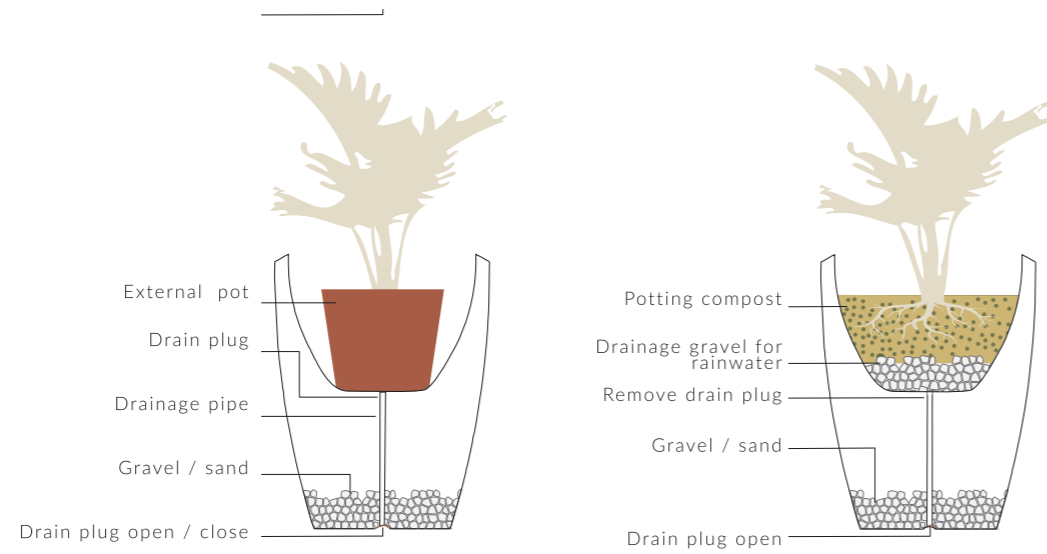

LED VARIANT

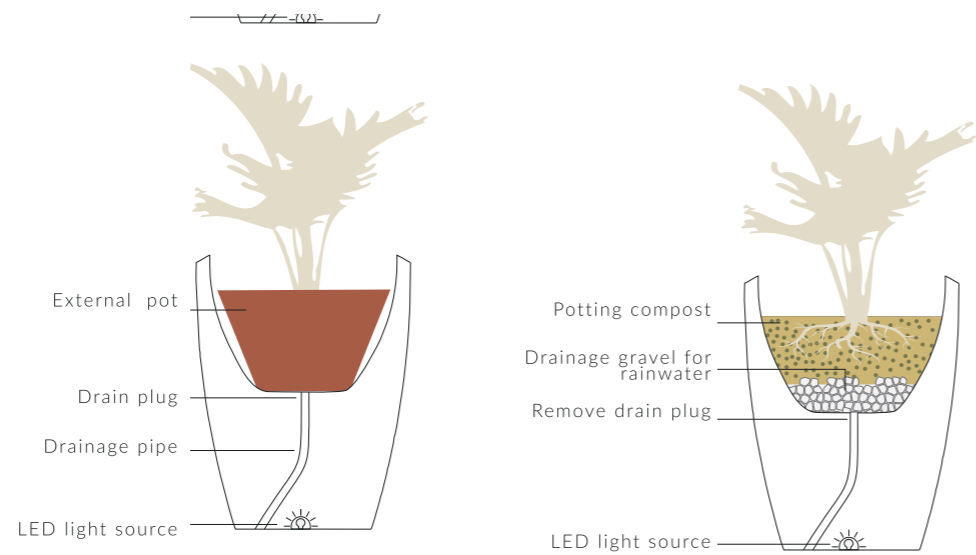

AVAILABLE IN

GRANITE FINISH

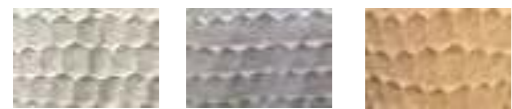

Milano Grey Sicilian Grey Baltic Brown

SOLID FINISH

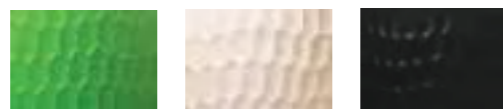

Irish Green Polar White Panther Black

TRANSLUCENT FINISH

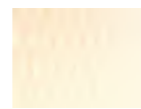

Translucent White



Dholpur Beige Exotic white Lava Black



Fire Red Flame Yellow

SIZES *

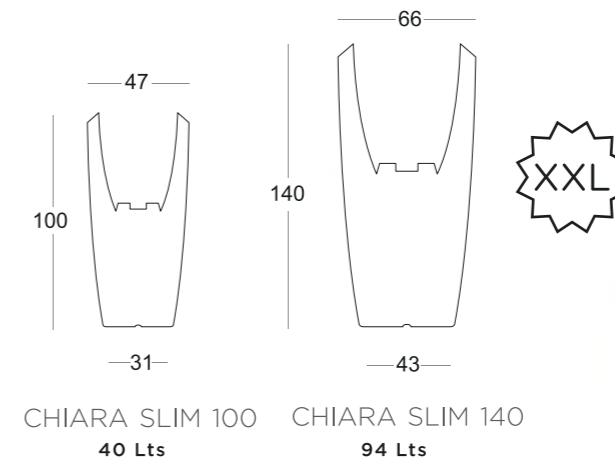
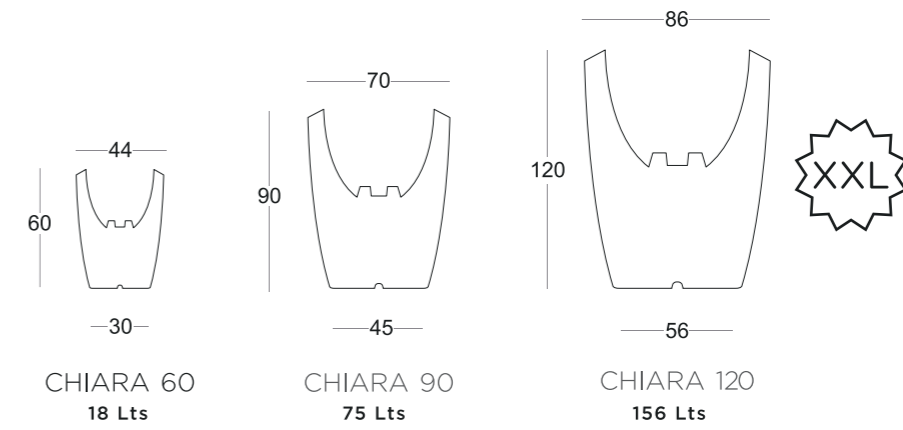

Vol: xxx Lts.

*ALL DIMENSIONS IN CENTIMETRES

*MORE COLOUR OPTIONS ARE AVAILABLE ON REQUEST



Piatto 10460 Translucent White with LED



PIATTO



Piatto 10460 Translucent White with LED



Piatto 7560 Baltic Brown with LED



PIATTO (Pi-aa-toh)

The shape of these versatile planters has been derived from that of a dish or a bowl. Using hand textures, like carved stone bowls this planter has a simple, unobtrusive flow with a classic design sensibility to it. These planters are deep enough to hold large plants and flower groupings. The scattered line texture brings to mind ancient outdoor planters, emphasizing the material and the beauty of stone planters. With options of illumination in half body, these planters adapt charmingly to their surroundings.

POTTING INSTRUCTION

HALF BODY

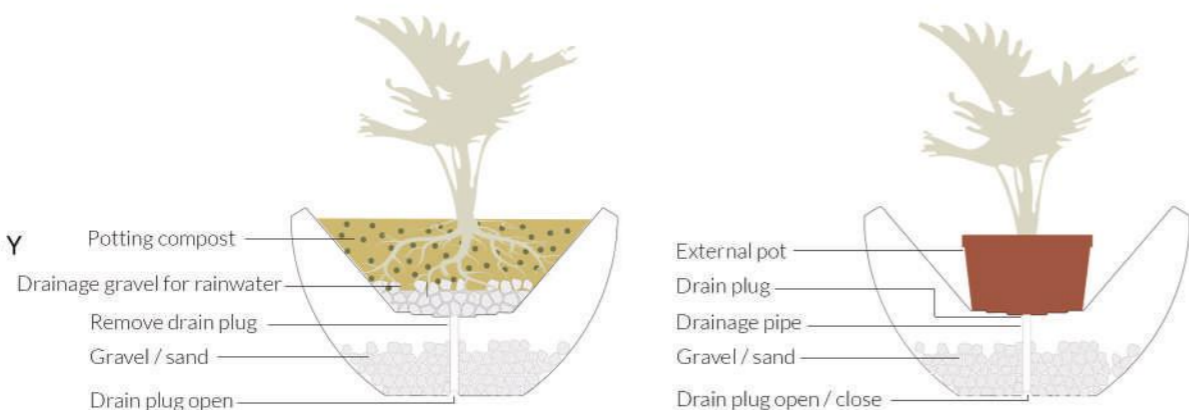

LED VARIANT

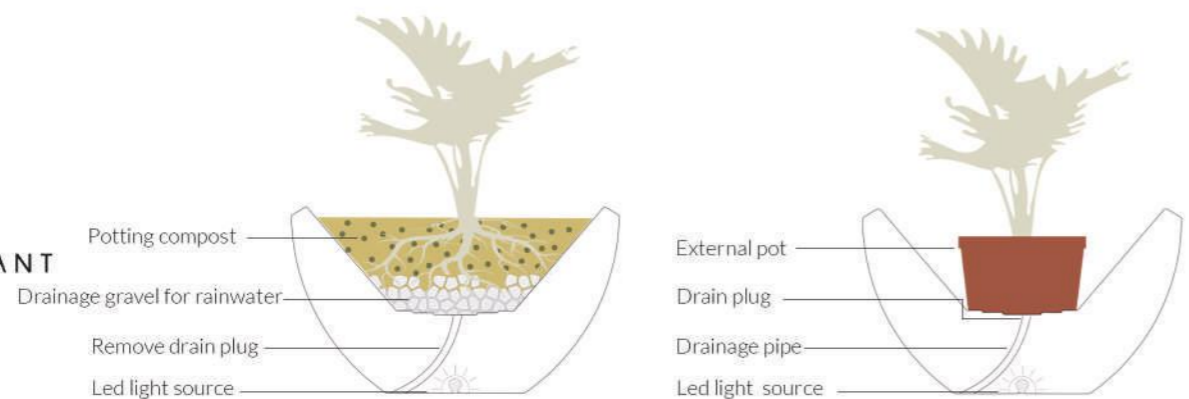

AVAILABLE IN

GRANITE FINISH



Milano Grey Sicilian Grey Baltic Brown

SOLID FINISH



Sherwood Brown Polar White Panther Black

TRANSLUCENT FINISH



Translucent White



Dholpur Beige Exotic white Lava Black



Fire Red Flame Yellow Irish Green

*MORE COLOUR OPTIONS ARE AVAILABLE ON REQUEST

SIZES *

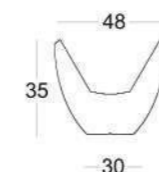

PIATTO 4835
15 Lts

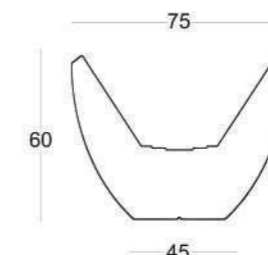

PIATTO 7560
60 Lts

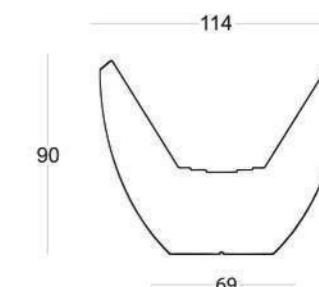

PIATTO 11490
195 Lts

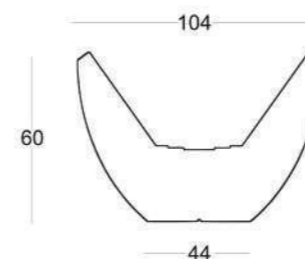

PIATTO 10460
138 Lts

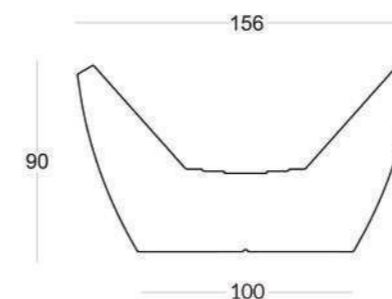

PIATTO 15690
415 Lts



Vol: xxx Lts.

*ALL DIMENSIONS IN CENTIMETRES





Left to Right: Elena 120 Baltic Brown with LED, Elena 90 Baltic Brown with LED



ELENA



Left to Right: Elena 90 Translucent White with LED, Piero-S Translucent White with LED



ELENA (ae - lee - na)

Italian & Spanish form of Greek Helene, means "torch". The shape of the Elena planter has been derived keeping the visual of a flame in mind. A top shoulder, simple lines with a provision to either directly fill the planter with soil or use potted plants. Play of light comes into effect when the planters are illuminated from within. These half body planters are great for outdoors as well as indoors. It has a drain which can be locked to put internal pots. As it is taller and narrower in diameter at the bottom, it is more economical with space but just as impressive.

SIZES *

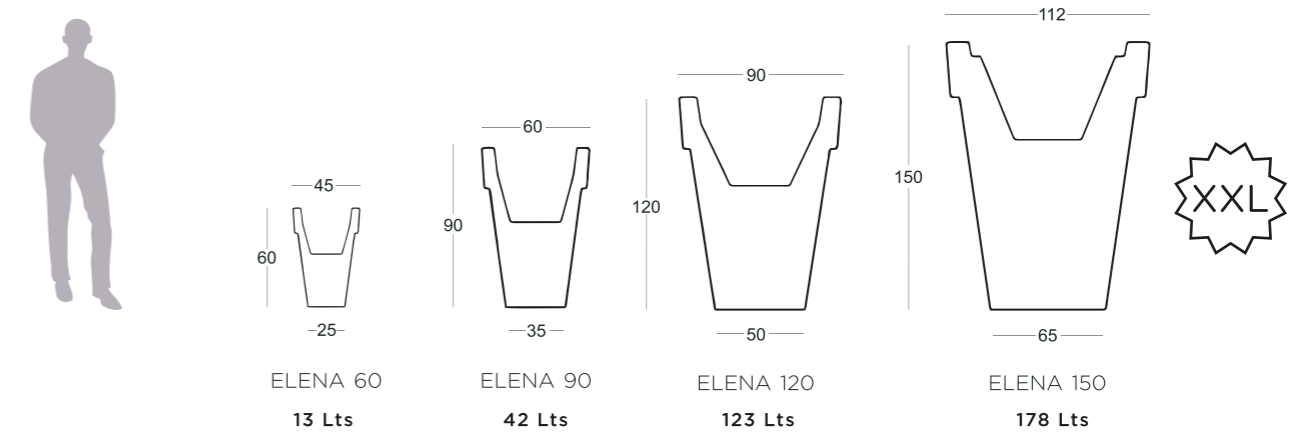

POTTING INSTRUCTION

HALF BODY

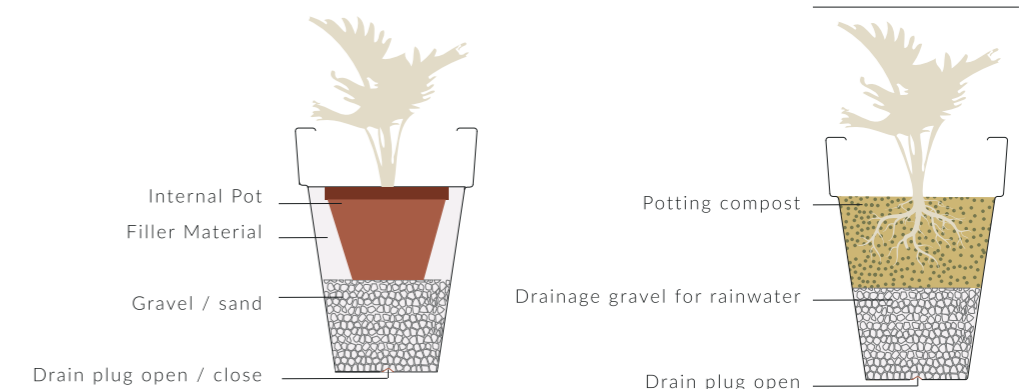

LED VARIANT

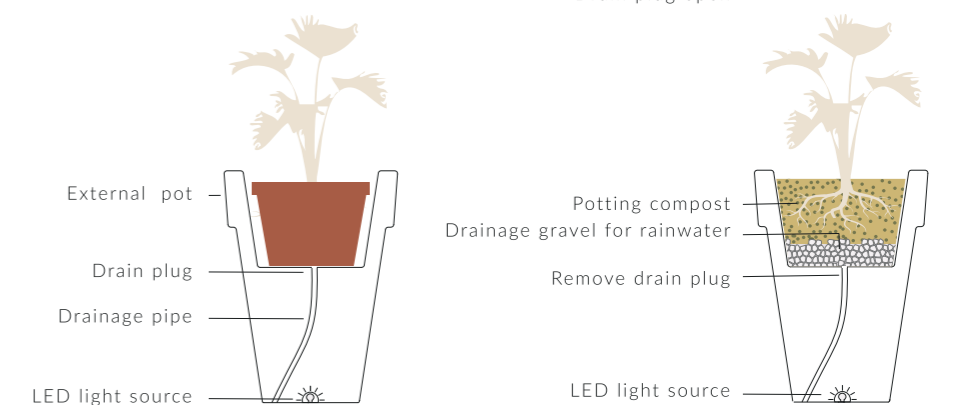

AVAILABLE IN

GRANITE FINISH



SOLID FINISH



TRANSLUCENT FINISH



Vol: xxx Lts.
*ALL DIMENSIONS IN CENTIMETRES

*MORE COLOUR OPTIONS ARE AVAILABLE ON REQUEST 67



Eloisa 90 Translucent white with LED



ELOISA

SIZES *

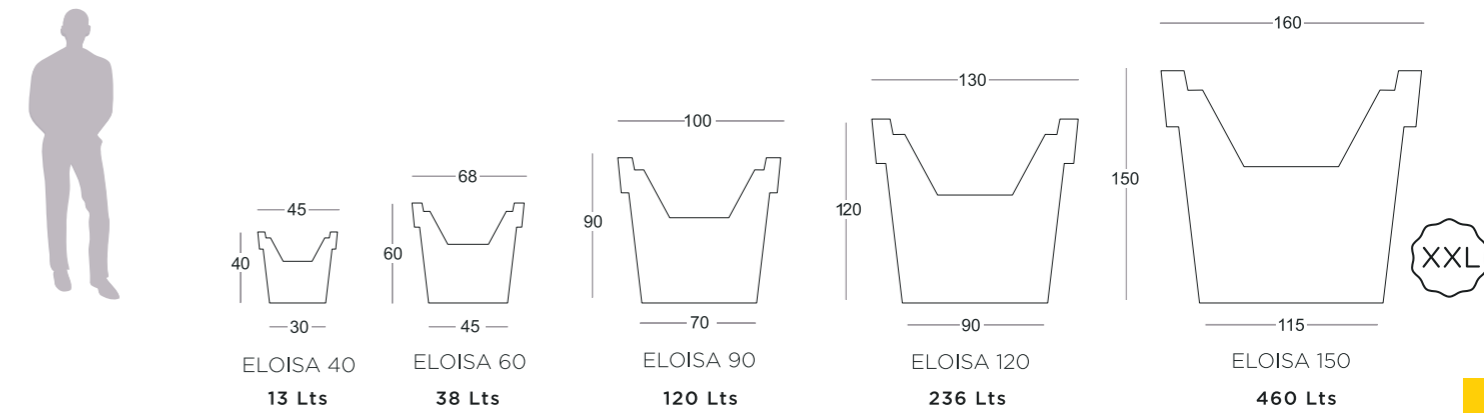

POTTING INSTRUCTION

HALF BODY

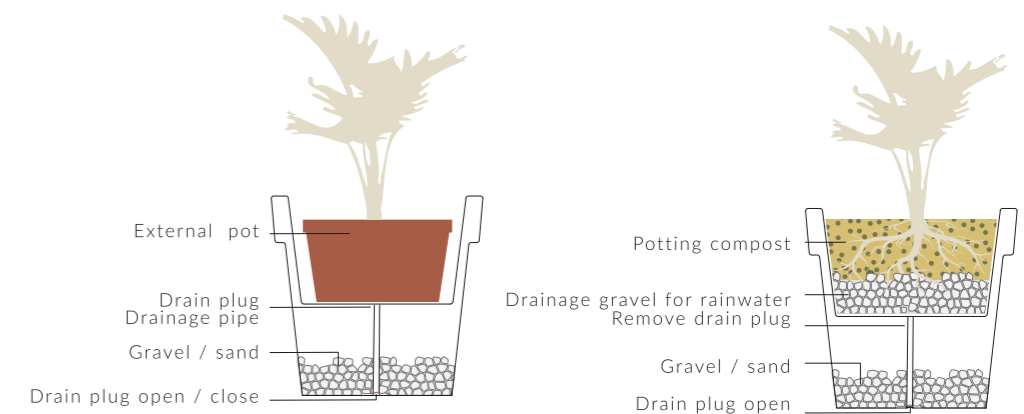

LED VARIANT

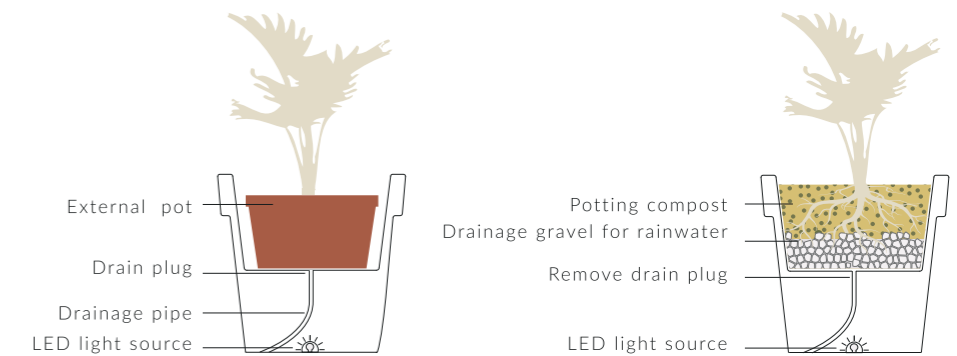

AVAILABLE IN

GRANITE FINISH



SOLID FINISH



TRANSLUCENT FINISH



Vol: xxx Lts.

*ALL DIMENSIONS IN CENTIMETRES

*MORE COLOUR OPTIONS ARE AVAILABLE ON REQUEST



Left to Right: Eloisa 90 Baltic Brown with LED, Eloisa 60 Baltic Brown with LED



ELOISA (ae - loi - sa)

A similar design language to the Elena but with a much wider bottom. With its large presence, these planters are great for big lawns, entrance porch or places where you want to show expansiveness. The Eloisa planter can be illuminated from within. Deep enough to hold large plants and flower groupings. When lit, only the colour of the pot and light are visible, not potting material.



Left to Right: Orabella 45 Baltic Brown with LED, Orabella 60 Baltic Brown with LED

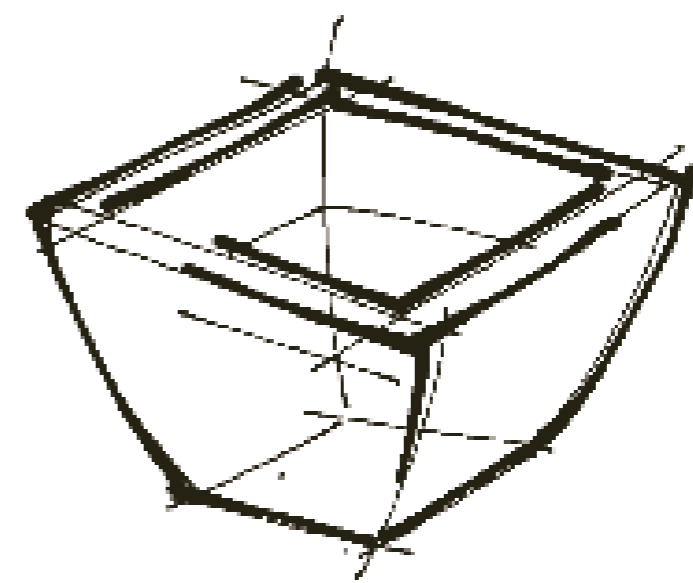

ORABELLA

SIZES *

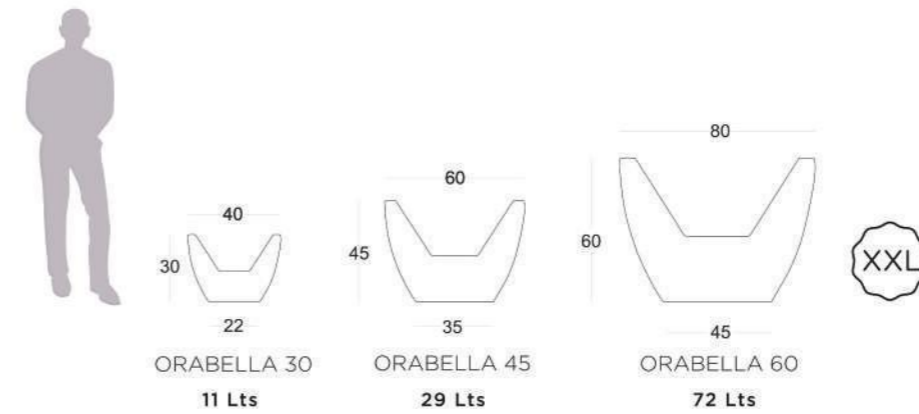

POTTING INSTRUCTION

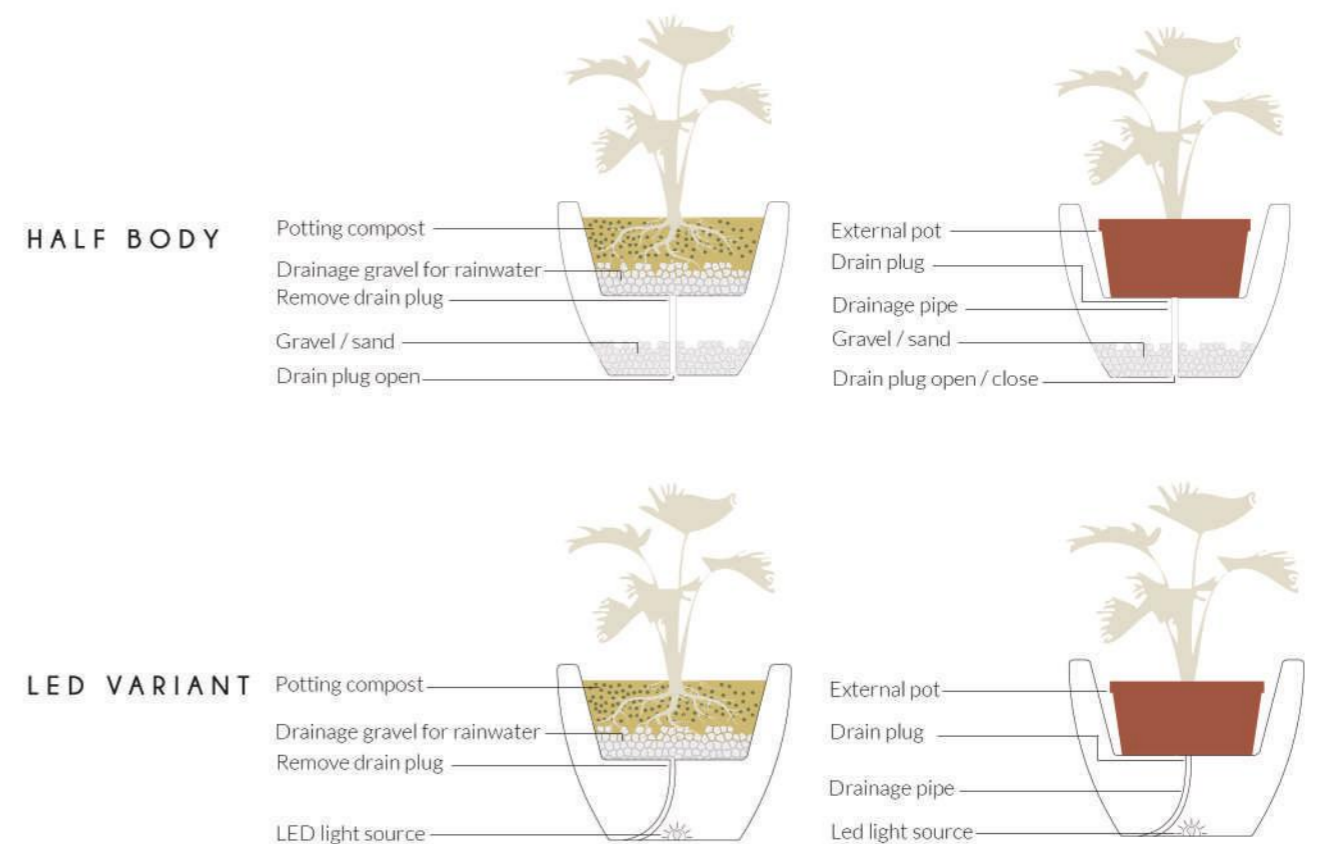

AVAILABLE IN

GRANITE FINISH



SOLID FINISH



TRANSLUCENT FINISH



Vol: xxx Lts.
*ALL DIMENSIONS IN CENTIMETRES

*MORE COLOUR OPTIONS ARE AVAILABLE ON REQUEST



Orabella 45 Baltic Brown with LED



ORABELLA

(o - raa - bella)

A pure geometric form that blends perfectly into modern spaces. Use Orabella in open spaces or corridors. These statement planters can be illuminated, and offer a great planting and visual experience. Internal cavity deep enough for plants up to 2 feet tall. These low height planters are great for indoors as well as outdoors.



Gioia 120 and Gioia 90 Translucent White with LED



GIOIA



Gioia 120 Translucent White with and without LED



Gioia 120 Baltic Brown without and with LED





Gioia 90 in Polar White



GIOIA (gee - oo - eaaa)

Minimal slim design gives a sense of lightness. Very small footprint, these illuminated planters can fit in tight spaces. Gioia means "happiness" - this is the principle of design for this product. Beautiful and versatile, the Gioia planters are a joy to be around. Available in three sizes, these planters are perfect for staircase landings and tight corners. Best used with an internal pot and illuminated.

SIZES *

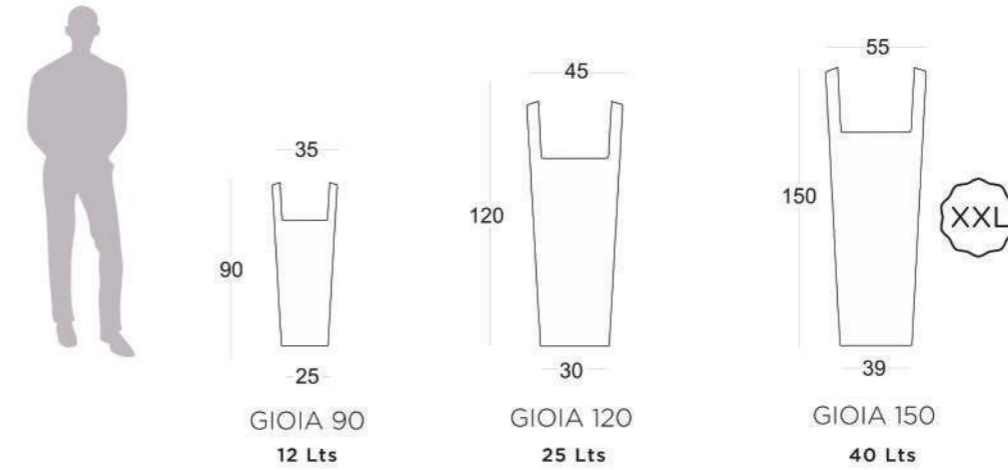

POTTING INSTRUCTION

HALF BODY



LED VARIANT



AVAILABLE IN

GRANITE FINISH

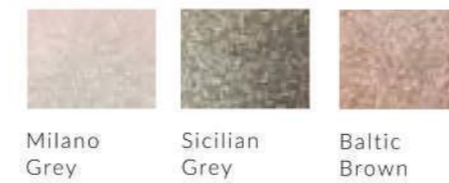

Milano Grey Sicilian Grey Baltic Brown

SOLID FINISH



Sherwood Brown Polar White Panther Black

TRANSLUCENT FINISH



Translucent White



Dholpur Beige Exotic white Lava Black

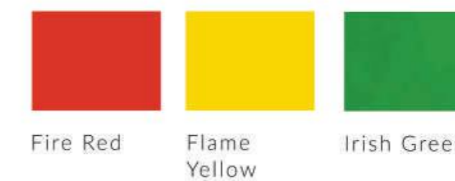

Fire Red Flame Yellow Irish Green

Vol: xxx Lts.
*ALL DIMENSIONS IN CENTIMETRES

*MORE COLOUR OPTIONS ARE AVAILABLE ON REQUEST

03

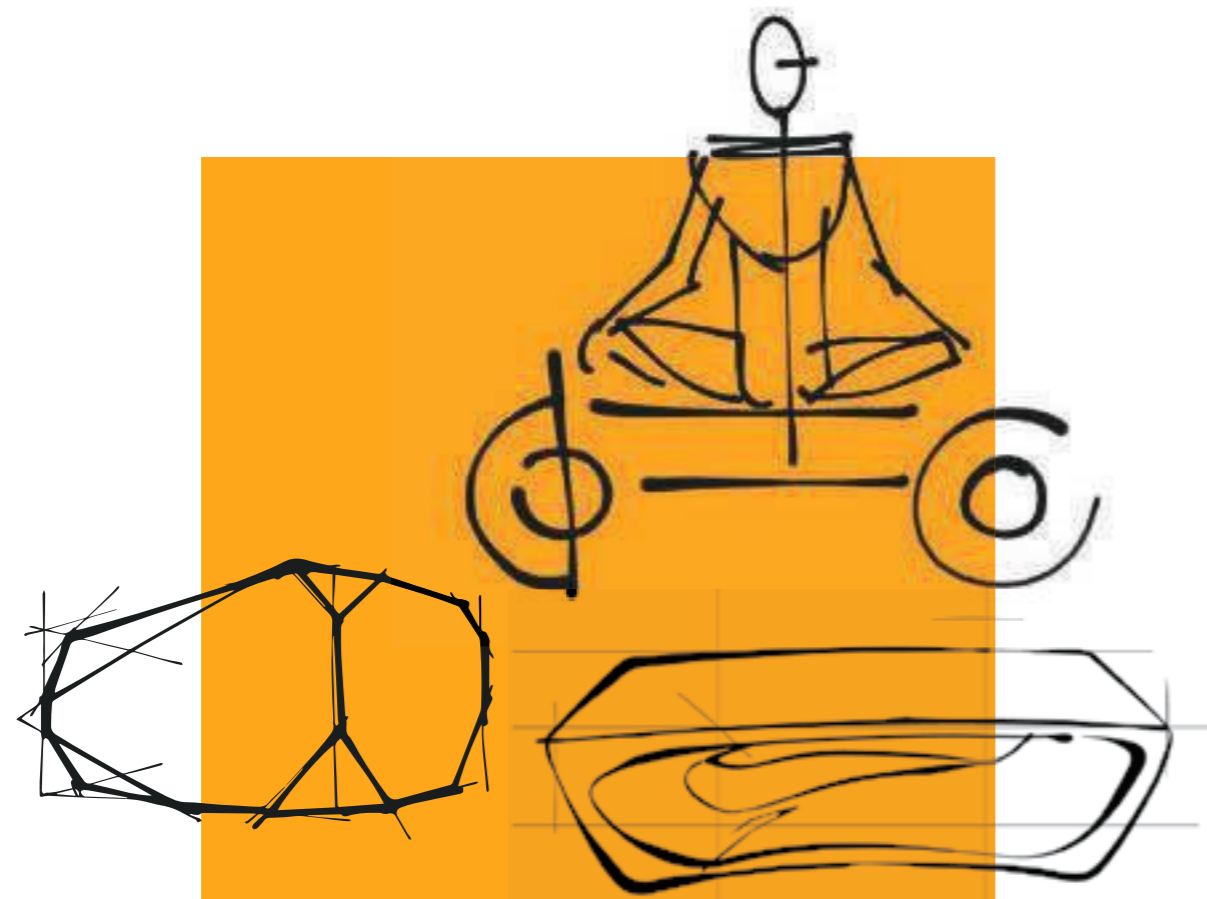

SEGGIO
(Seating)



100%
RECYCLABLE



NON-FADING
COLORS



EASY TO
CLEAN



UV
STABLE



ANTI
FROST



MOULDED
WITH LOVE



LED
VARIANT



RUST
PROOF



Clockwise from top : Piero Baltic Brown, Exotic White, Lava Black

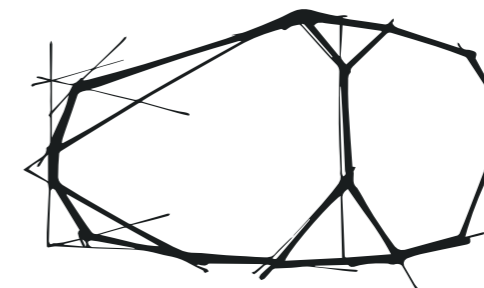

PIERO



Piero-L , Piero-S , Chiara 90 Translucent White with LED



Clockwise from left : Piero Lava Black, Exotic White, Baltic Brown, Exotic White, Baltic Brown

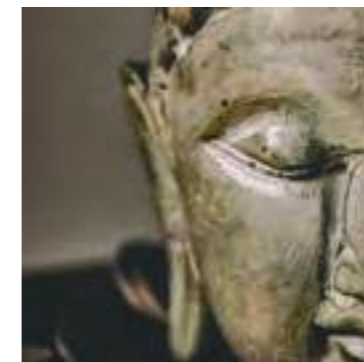

PIERO (Pee-ae-ro)

Piero means "stone". Designed keeping versatility as its primary function, the Piero can be used as seating or a table. It is simply beautiful and elegant in all its forms – solid colours, stone textures or illuminated. Place it around lawns, courtyards, gardens, terraces, pool side, or even indoors – it has no sharp edges and is very comfortable to sit on. The Illuminated version comes with an inbuilt rechargeable battery, making it easy to place without the worry of wires and plugs.

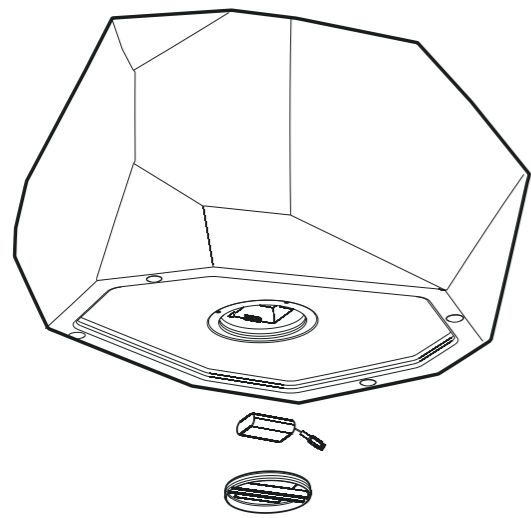
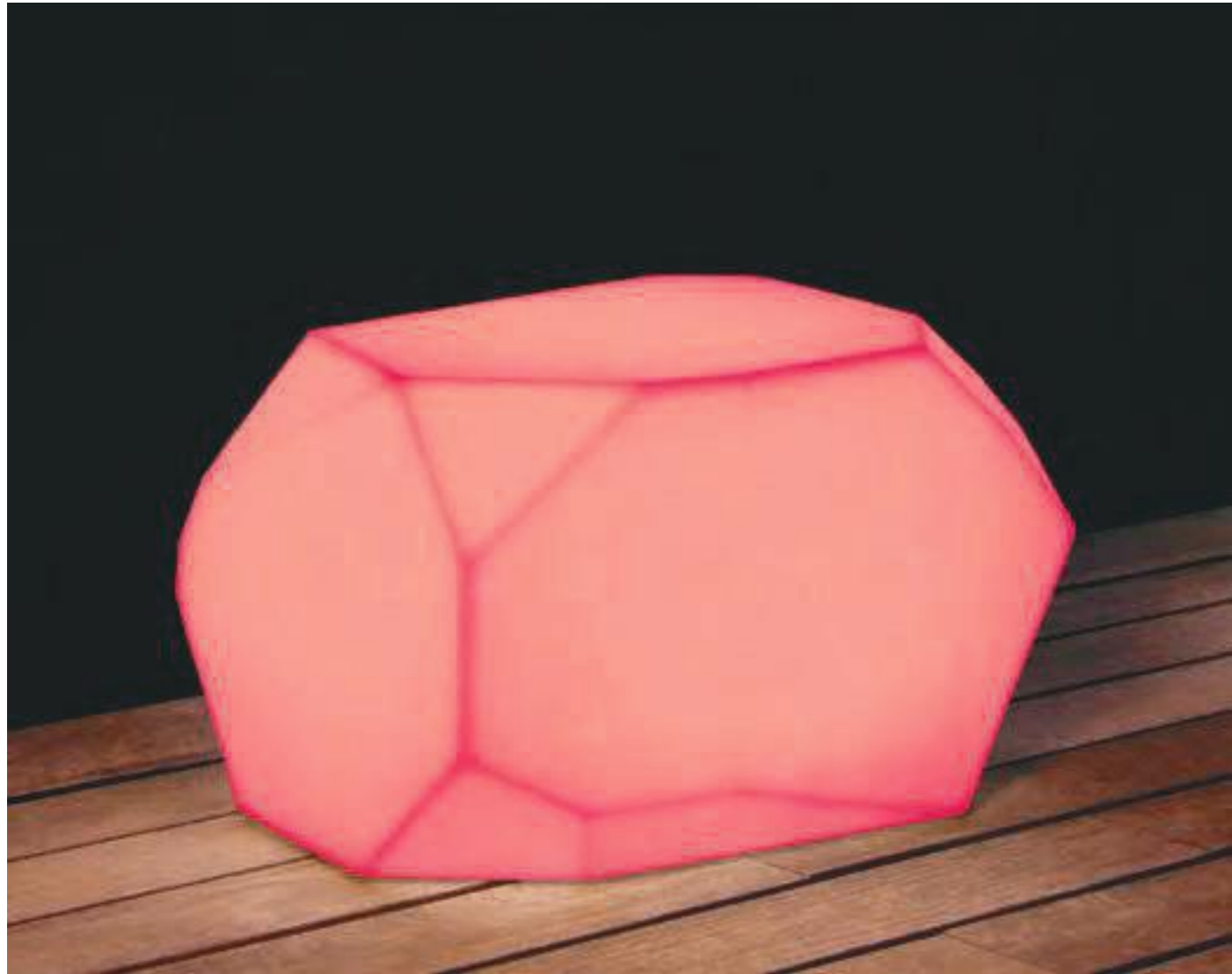

Pieros come with in-built Li-Ion rechargeable battery and chargers. RGB mood lighting models are supplied with RF remote to change colours.



Piero-L, Piero-S Translucent White with and without LED

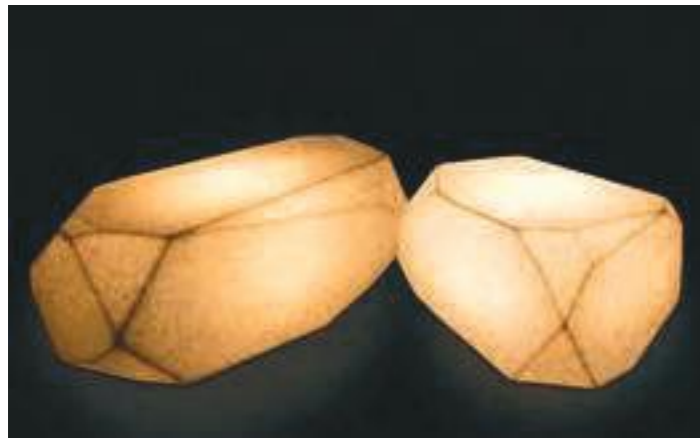

Piero-L, Piero-S, Chiara 90 Exotic White with and without LED

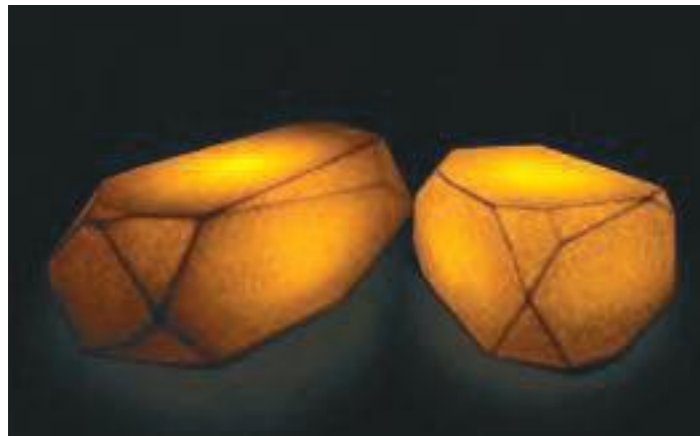

Piero-L, Piero-S Baltic Brown with and without LED



Available in translucent, Exotic White, and Baltic Brown finishes. Piero looks great in the day and night with or without illumination.

SIZES *

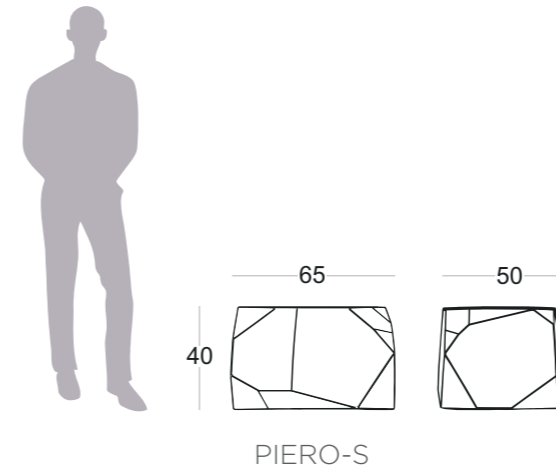
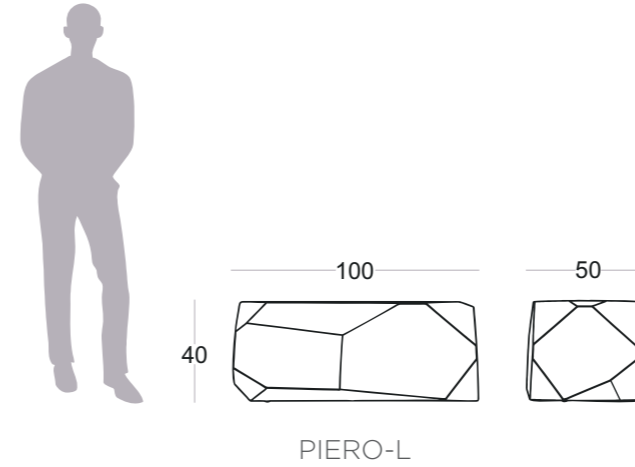

AVAILABLE IN

GRANITE FINISH



Milano Grey



Sicilian Grey



Baltic Brown



Dholpur Beige



Exotic white



Lava Black

SOLID FINISH



Sherwood Brown

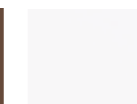

Polar White



Panther Black



Fire Red



Flame Yellow



Irish Green

TRANSLUCENT FINISH



Translucent White

*ALL DIMENSIONS IN CENTIMETRES

*MORE COLOUR OPTIONS ARE AVAILABLE ON REQUEST

2017 WINNER
**EUROPEAN
PRODUCT
DESIGN
AWARD**
PLATINUM



Top to Bottom: ENEA in Baltic Brown, Milano Grey, Sicilian Grey

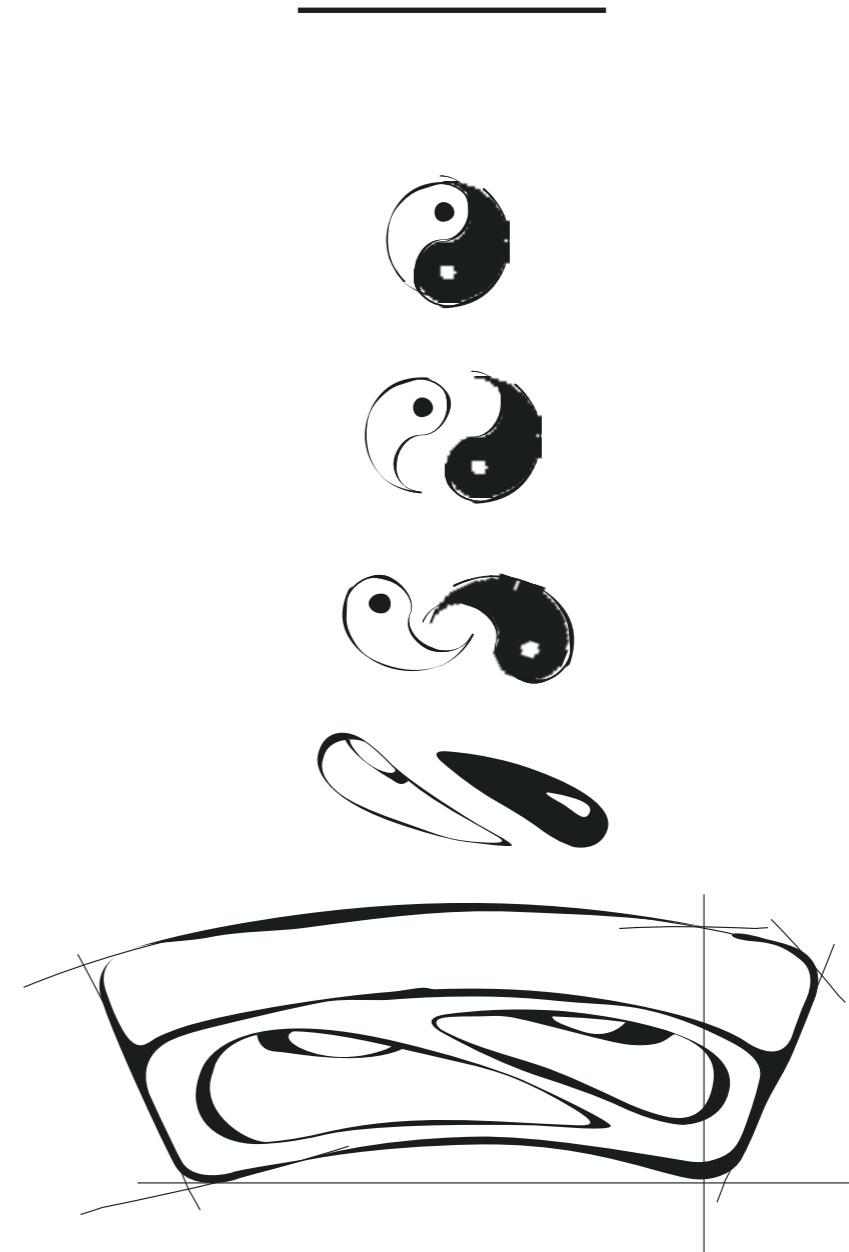

ENE A



Clock wise: Baltic Brown, Milano Grey, Lava Black, Sicilian Grey



ENE A

(en-eya)

Inspired from the Chinese philosophy of the Yin & Yang, where apparently contrary forces are actually complementary, interconnected, and interdependent in the natural world.

Shadow cannot exist without light. The yin-yang shows a balance between two opposites with a part of the opposite element embedded in each other.

This beautiful crafted seat can be seen holding these elements perfectly within itself.

SIZES*

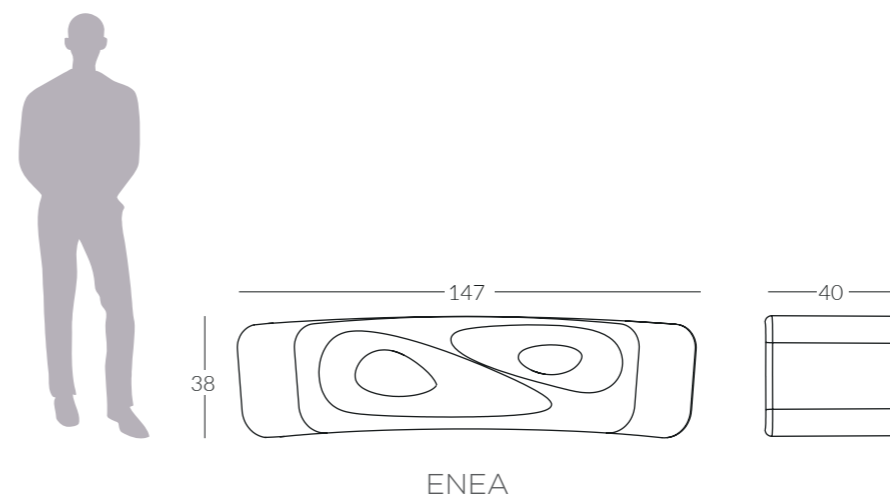

AVAILABLE IN

GRANITE FINISH



SOLID FINISH



*ALL DIMENSIONS IN CENTIMETRES

*MORE COLOUR OPTIONS ARE AVAILABLE ON REQUEST



Top to bottom: Cara Baltic Brown, Milano Grey, Sicilian Grey

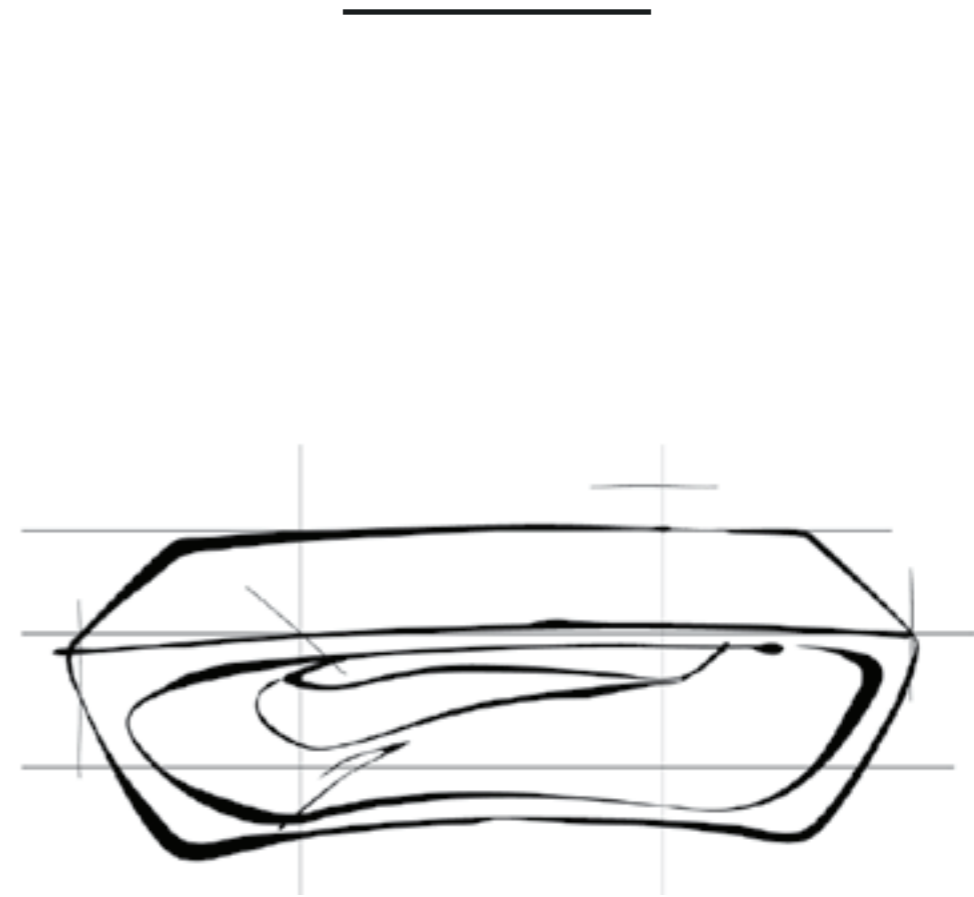

CARA



Cara Baltic Brown



CARA (Kaa-ra)

A bench unlike no other with a part of it is curved to provide a unique design definition. Solidly built with a large opening and incorporating a flow motion within itself. Cara is a graceful seat for lawns, balconies, terraces and looks stunning in stone textures.

SIZES *

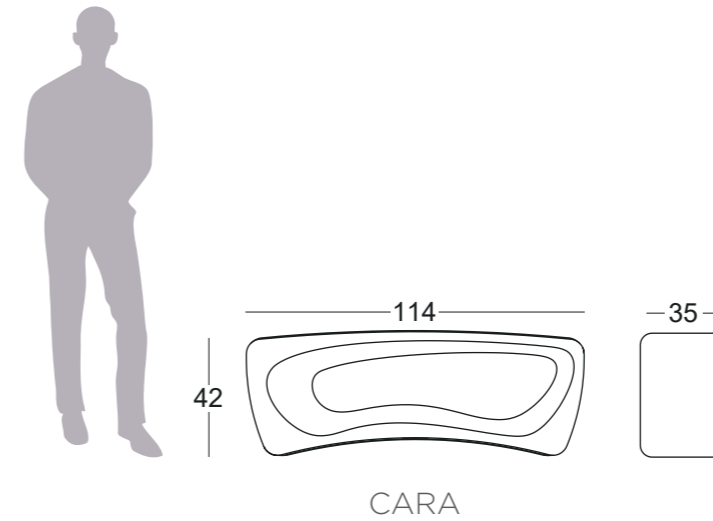

AVAILABLE IN

GRANITE FINISH



SOLID FINISH



*ALL DIMENSIONS IN CENTIMETRES

*MORE COLOUR OPTIONS ARE AVAILABLE ON REQUEST



Ilaria Milano Grey, Sicilian Grey, Baltic Brown



ILARIA



Left to Right: Ilaria Baltic Brown, Sicilian Grey



ILARIA

Designed keeping in mind the Indian musical instrument – Sitar. A concept of seating that can be used in multiple ways. Simple form, dynamic, full of freshness that offers maximum comfort to its users and effortlessly blends itself to any surrounding. Ilaria means “joyful”. Available in stone textures, Ilaria is an ideal casual seating.

SIZES*

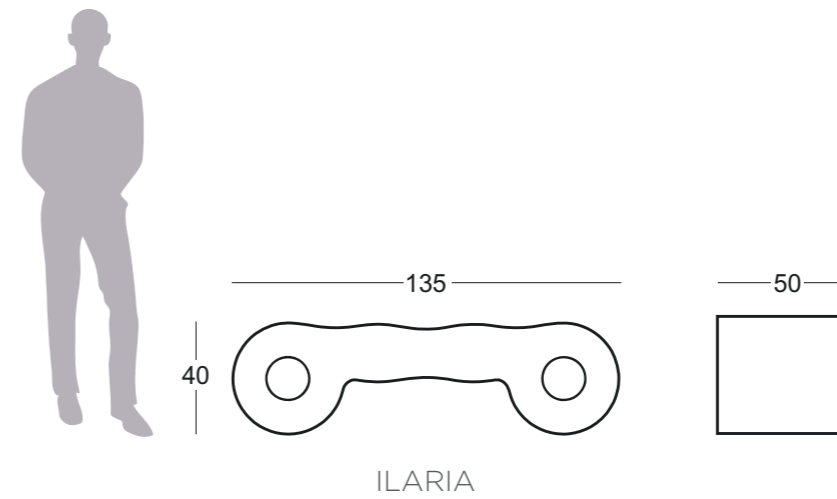

AVAILABLE IN

GRANITE FINISH



*ALL DIMENSIONS IN CENTIMETRES

04

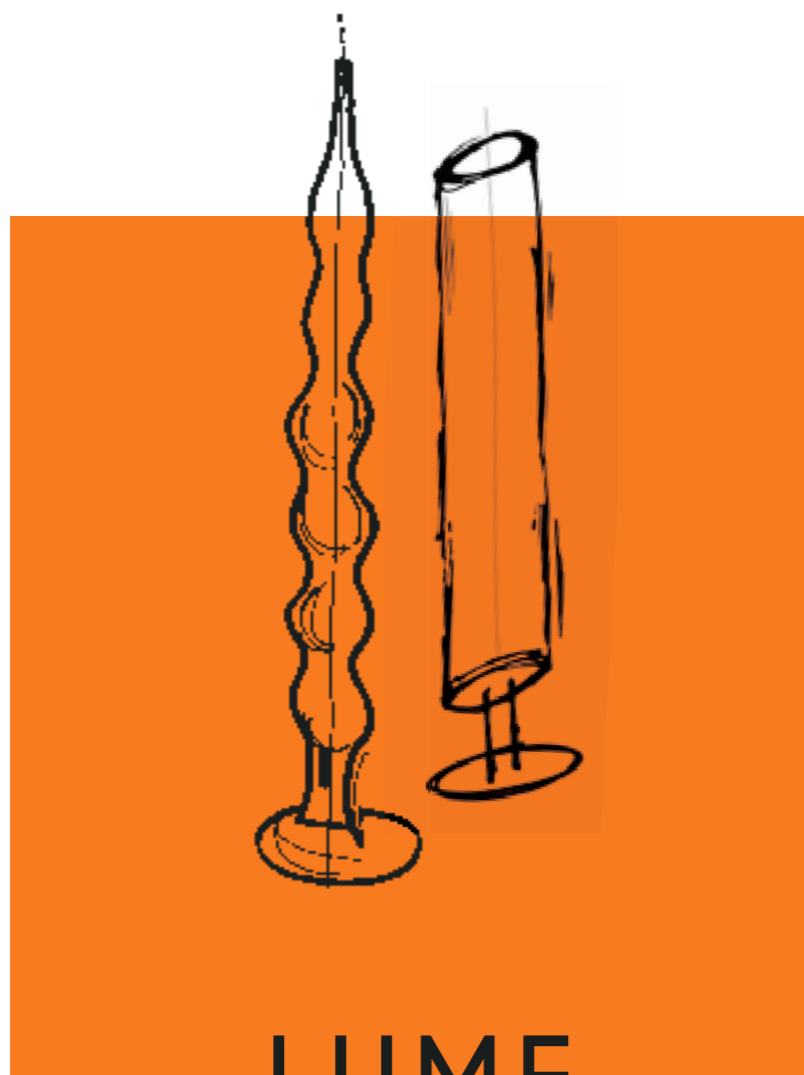

LUME
(Lamps)



100%
RECYCLABLE



NON-FADING
COLORS



EASY TO
CLEAN



UV
STABLE



ANTI
FROST



MOULDED
WITH LOVE



LED



RUST
PROOF



Triangolo



OVALE • TRIANGOLO • ESAGONO



Triangolo



Ovale



OVALE · TRIANGOLO · ESAGONO

The Lume series comprises of Ovale, Triangolo, Esagono and the award winning Seme. All these floor standing lamps are over 2 meters tall and create a striking effect of light and shade that is one of its kind. Depending upon the model, Lume can be placed indoor or outdoor as these are awe inspiring theatrical objects. Options include single colour, dual colour or RGB mood lighting. The white matte of the polymer lamp spreads the light softly, creating a contrast with the deep black hammer effect of the base structure. The lamps come with a dimming effect to choose your perfect light mood.



Ovale



Ovale



Esagono



Triangolo



ENERGY SAVING LED

Lume incorporates strip LED system for efficient lighting. You have a choice of Warm White, White or mood changing RGB LED's.



RF CONTROLLER

Mood lighting RGB Lume are provided with RF remote which have a distance of nearly 10 meters. Further, dimming options are also available upon request.

SYNC

You can sync upto 4 lamps together with one remote to get the best mood lighting effect.



Triangolo

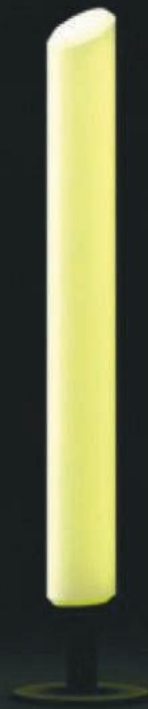

Ovale



Esagono



Ovale

SIZES*

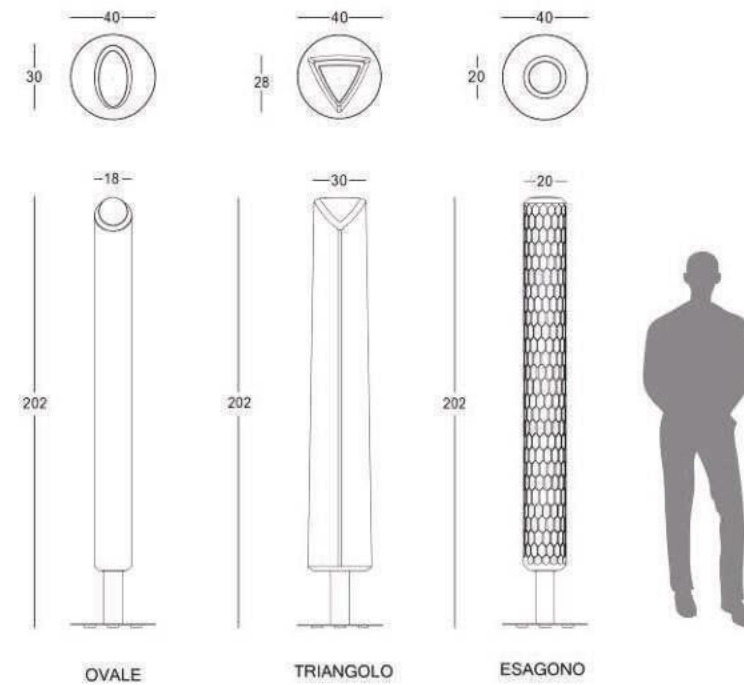

AVAILABLE IN

TRANSLUCENT
FINISH



Translucent
White

TRANSLUCENT
FINISH



Translucent
White - Esagono

*ALL DIMENSIONS IN CENTIMETRES



Seme



2013-2014
Rotational Molding
Product Design
Competition

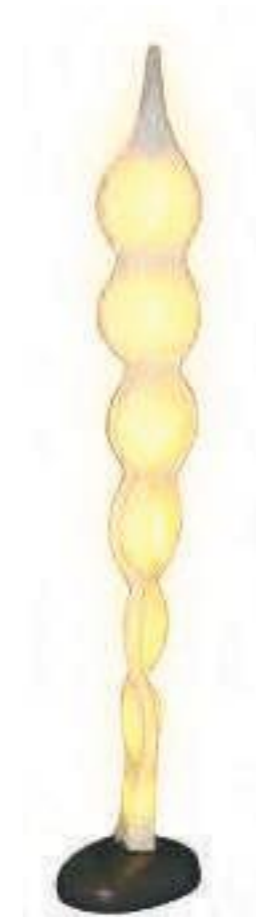

S E M E



Seme

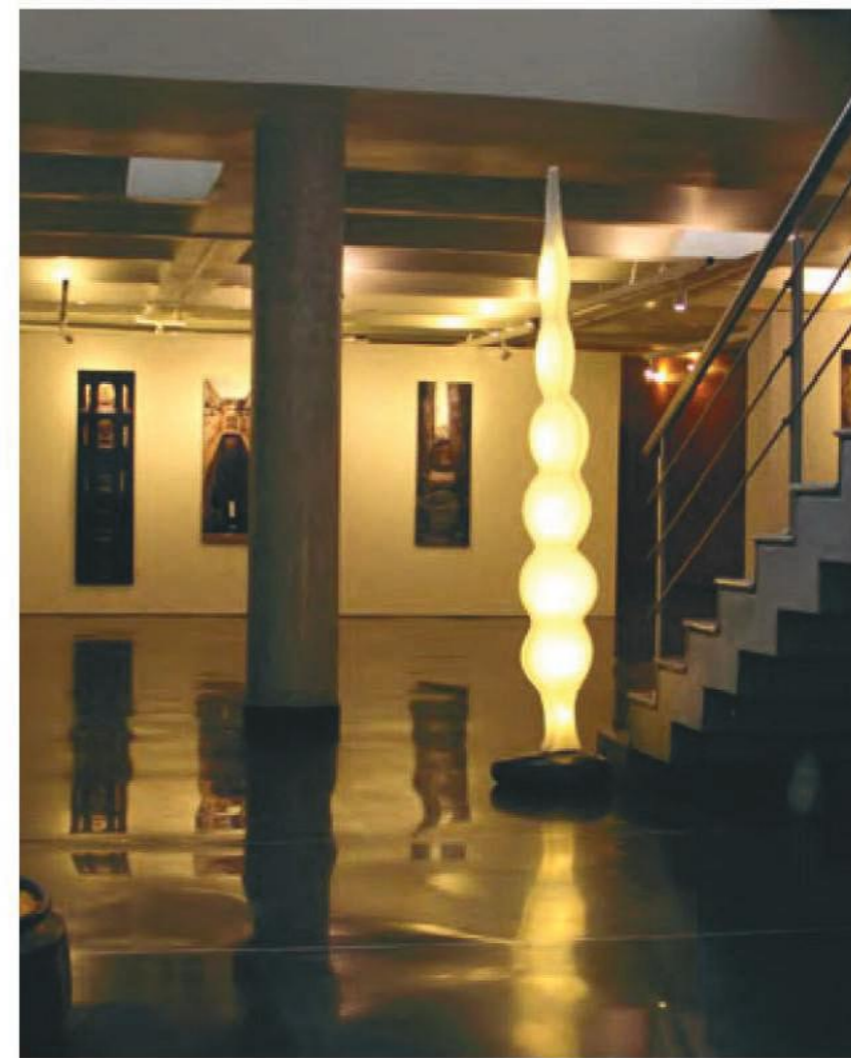

Seme

SIZES*

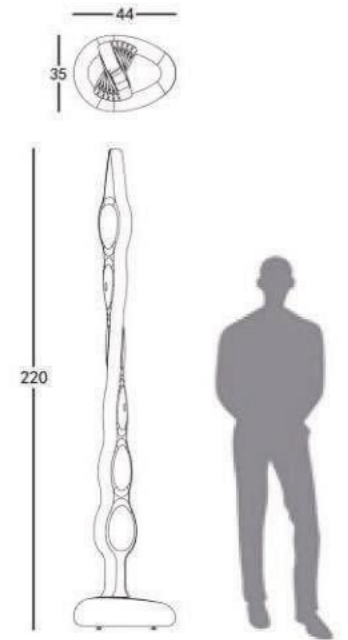

Seme

*ALL DIMENSIONS IN CENTIMETRES

SEME

(say-may)

There is a magical seed shrouded in legend, known as Entada gigas. The seeds of this pan tropic represents life, hold promises of the future and memories of the past.

Our Seme lamp is inspired from this magnificent giant seed, giving a feeling of climbing the skies gracefully and glowing with a quiet energy. It uses a soft ambient light that brings life to interiors and exteriors. Available either with floor or ceiling mounting options.



Designed By
Falguni Gokhale

AVAILABLE IN

TRANSLUCENT FINISH



Translucent
White



POLYMER

Lume series is made from frost resistant, 100% recyclable PolyEthylene (PE). It is UV stabilized and impact resistant. Lume can withstand temperatures from - 30 Deg C to + 70 Deg C.



GALVANISED AND POWDER COATED STEEL

Its easy to fix Lume series on the helix screw for beach applications. Just rotate the helix screw into the beach and bolt the Lume to it. This way you can enjoy bright luminescence of Lume close to river or sea.

EASY TO HANDLE

Lume is easy to handle despite its length of 2 meters. The indoor version weighs only Kg. Always lift from the base to reposition.

STABILITY

Lume has a low center of gravity as nearly 80% of the weight is at the bottom. This prevents any accidental tripping of the base.

IN GROUND FIXING

For in ground fixing, a GI collar tube is provided to fix into the concrete block. On top of this the outdoor version of Lume can be bolted.

TEMPORARY FIXING

A plate and anchoring bolts are supplied for temporary installations on lawns for special events. These cause min damage to grass or soil.

CLEANING

Always use a mild detergent usually found in your kitchen to give Lume a scrub if required. Use soft cotton and lint free cloth.

Large sizes

Modern designs

Range of non-fading colours

Single wall and double wall planters

Easy to clean

Light weight

Indoors / outdoors

Shock resistant

Withstand temperature range

of -20° C to 70° C

Hand finished

UV stabilized

100% recyclable

 Certified LED Planters



Moodie
Outdoor Products

www.moodie.com.au
sales@moodie.com.au
1300 666 343



Moodie
Outdoor Products

www.moodie.com.au
sales@moodie.com.au
1300 666 343

SERENO™



SERENO is a registered trademark owned by Frontier Polymers Pvt Ltd. Exact shades of products cannot be reproduced on paper. Sizes and colours are at the discretion of the management and subject to change without intimation.